

REGIONAL WATER SUPPLY & WASTEWATER STUDY

**FOR THE
CITY OF WESLACO, TEXAS**

05-483-085F Pt.1

PART 1 - WATER

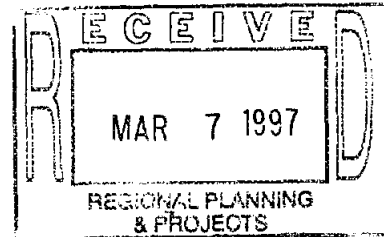

FINAL REPORT

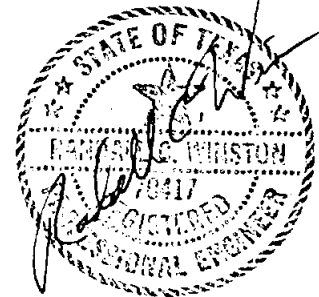

2/28/97

February 1997

**Sigler, Winston, Greenwood & Associates, Inc.
Consulting Engineers
1604 E. Hwy. 83
Weslaco, Texas**

Amended
Modification of Rate

8. At present the District's flat rate assessments to irrigators which is the annual assessment made on irrigable land in the District's boundaries regardless of value or use, is \$6.52 per acre; its water delivery charge (DC), the charge for a single irrigation of an acre is \$6.20. These are fixed not more than annually, barring emergencies. As either or both of these charges are changed, the new rate (R) to be paid by the City for delivery of each 1,000 gallons of water shall be determined by the following formula:

$$\frac{\text{New R}}{\text{Prior R}} = \frac{\text{New FR} + \text{New DC}}{\text{Old FR} + \text{Old DC}}$$

The rate as so modified shall be effective at the time each change in flat rate (FR) or water delivery charge (DC) is effective for those in the District receiving irrigation water from the District. The initial R to be used in the first adjustment shall be 8.0¢ per 1,000 gallons, and the initial FR (i.e., "Old FR") and DC (i.e., "Old DC") shall be the current amounts as set out above.

Point of Delivery

9. Water will be furnished and delivered to City at a point of delivery located near where raw water flows into the City's storage reservoir on Mile 9 North Road immediately downstream of District's existing second lift station. The delivery point and mode of installation of the intake structure(s) shall be agreed upon between the District and the City. Any changes in the point of delivery or any new or additional

points of delivery shall be by mutual agreement of the District and City.

Billing Procedure

10. District will furnish City at its offices in Weslaco, Texas, not later than the 10th day of each month, a statement of the amount of water delivered to the City during the preceding month and the amount due the District for such deliveries. City shall pay the amount due within 10 days following the date such statement is mailed or delivered by the District to City.

11. In the event the City fails to pay the water delivery charges as they become due, the District may cease deliveries of water under this Contract after thirty (30) days written notice to City. A late charge of \$100.00 per month or 18% calculated on a per annum basis (1 1/2% per month) on the amount of water delivery charges owed, whichever is greater, shall be paid by City to District until such water delivery charges are paid. Such late charge shall be considered a part of the water delivery charges owed.

Measurement of Water Delivered

12. (a) City agrees to furnish, install, operate and maintain at the delivery point or points, as mutually agreed upon, the necessary metering equipment and required devices of standard type to measure the quantity of water delivered by District and to calibrate such metering equipment whenever requested but not more frequently than once every six (6) months. A meter registering not more than two percent (2%) above

or below the test result shall be deemed accurate. The previous readings of any meter disclosed by test to be inaccurate shall be corrected for the 90 days previous to such test in accordance with the percentage of inaccuracy found by such tests. If any meter fails to register for any period, the amount of water furnished during such period shall be deemed to be the amount of water delivered in a corresponding period with a similar rate of flow conditions as prior to the failure unless District and City shall agree upon a different amount. The metering equipment shall be read by the District on the same date each month as determined by the District after advice and consultation with the City. The City shall have access to read the meter.

(b) The amount measured by such meter(s) or measuring devices shall be the amount, rounded to the nearest 1000 gallons, upon which billings provided for in paragraph 10 above, shall be based.

Water Losses

13. The City shall be responsible for loss of water that may occur between the District's diversion point on the Rio Grande and the City's delivery point(s) for water right allocation purposes. It is agreed that such losses shall be twenty-six (26%) percent (or $1.35 \times$ amount of water delivered to City measured as provided above), however such loss shall not be included in the amount of water delivered hereunder for billing as provided in paragraph 10 above, but will be taken into account in reporting the amount of water diverted from the Rio Grande by

District for the City for water use reporting purposes and as regards to accounting and charges against the City's water allocation as provided for under this Contract.

Delivery of Water Limitations

14. The District will take reasonable measures necessary to deliver to the City quantities of water to which the City is entitled under this Contract, and temporary or partial failure to deliver water shall be remedied with all reasonable dispatch. Provided, however, District shall have no liability to City or its citizens or its treated water customers for any failure of delivery service caused by a canal blow-out or breakdown of its pumping facility, flumes, inverted syphons or physical inability to deliver water, whether the result of an act of God or the negligent or deliberate acts of District's employees or other or for reasons beyond the control of District or for reasons set forth in paragraph 16 below. District shall be liable for failure of service only if occasioned by the wrongful refusal of its Board of Directors or Manager to deliver water to the City.

Limitation of Liability for Pollution

City to Hold District Harmless

15. District shall have no liability to City or its citizens or treated water customers for any pollution or contamination of water delivered to City unless caused by the deliberate act of District's Board of Directors or Manager. The City agrees to hold District harmless for any claim or demand which may be

made against District growing out of pollution or contamination of water delivered under this Contract unless caused by the deliberate or negligent act of the District's Board of Directors or Manager.

Water Supply Shortage

16. In the event District is unable to deliver all of the water to which City is entitled under this Contract because of low water supply in the Rio Grande and Falcon and Amistad Reservoirs, the supply to the City will be reduced in the same proportion as other municipal users in the Lower Rio Grande (that area lying downstream on the Rio Grande below Falcon Reservoir) under the administration of the TWC Rio Grande Watermaster or his successor; provided, however, this provision shall not control if the reason for District's inability to serve is due to the City having insufficient water allocation rights to the Rio Grande under this Contract so as to allow District to divert and deliver water to City, in which case District shall not be responsible for making water deliveries to City.

Regulatory Agencies

17. It is agreed that this Contract is subject to such rules, regulations, or laws as may be applicable to similar contracts in the State of Texas, and the District and City will collaborate in obtaining such permits, certificates, or the like as may be required to comply therewith. It is also agreed that as soon as it is practicable following the approval and execution

of this Contract by the parties, a copy of the Contract will be filed with the Texas Water Commission.

Successor to a Party

18. It is agreed that in the event of any occurrence rendering a party incapable of performing under this Contract, any successor of the party succeeding to the statutory functions of such party, whether the result of legal process, assignment, or otherwise, shall succeed to the rights of such party hereunder. This Contract shall be binding upon an inure to the benefit of such successor(s) to the parties; provided, however, that City may not transfer or assign its water allocation rights or water delivery rights under this Contract to any other party without the prior written consent of the District.

Water Use Reports and Assessments

19. The District will make the necessary Rio Grande water diversion reports to the Rio Grande Watermaster of the TWC or its successor, relating to the amount of water diverted from the Rio Grande for City, based upon the amount of water metered (measured) as provided above, plus the amount of transportation losses incurred in transporting the water from the Rio Grande to the City's delivery point(s) calculated as provided in paragraph 13 above. The City shall pay all assessments made by the TWC with respect to water to which the City is entitled under this Contract.

Enforcement

20. IT is agreed that either party hereto may demand specific performance of this Contract.

Laws and Regulations

21. This Contract shall be subject to the Rules and Regulations of the TWC, or its successor, as they presently exist or as they are hereafter amended to the extent such Rules and Regulations pertain to the operations of the parties under this Contract. This Contract shall be subject to all valid applicable state, federal and local laws, rules and regulations; provided, that either party hereto shall be entitled to regard all laws, rules and regulations issued by an federal or state regulatory body as valid and may act in accordance therewith until such time as the same may be held in invalid by final judgment in a court of competent jurisdiction after all applicable court appeals have been exhausted.

Invalidity of Provisions

22. In the event any provision hereof is declared invalid by a final judgment of a court of competent jurisdiction, after all applicable court appeals have been exhausted, such invalidation shall invalidate this Contract and it shall be of no further force and effect if the provision so invalidated renders this Contract unperformable by either party and frustrates the purpose of the Contract.

Term of Contract

23. This Contract shall become effective immediately and shall remain effective thereafter unless amended or terminated by mutual agreement of the parties. In the event the City fails to comply with any of the provision hereof, District after giving City thirty (30) days advance written notice of the provision so violated, may terminate the operation of this Contract pending the curing of City of its said default.

Amendments and Supplements

24. All amendments and supplements to this Contract shall be in writing in suitable form for recordation in the Official Records of Hidalgo County and be mutually agreed upon by both parties.

Service to Excluded Lands

25. District shall not be obligated to furnish and deliver water for irrigation or other purposes to lands excluded pursuant to the Exclusion Statute.

Authorization

26. Those representative of the parties executing this Contract on behalf of the parties represent one to the other that they are authorized by action of the governing bodies of each party to execute this Contract.

000137

DATED AND EXECUTED by the parties through their authorized representatives on the dates indicated below.

HIDALGO AND CAMERON COUNTIES
IRRIGATION DISTRICT NUMBER 9

By: *Ralph Powell*
President
Board of Directors

ATTEST:

Paul J. Heller
Secretary

Date: *Feb. 9, 1989*

CITY OF WESLACO

By: *Amanda C. Leonard* *all A*
Mayor

ATTEST:

Amanda C. Leonard
City Secretary

Date: *February 9, 1989*

Item II (5.2)

STATE OF TEXAS {
 {
COUNTY OF HIDALGO {

This instrument was acknowledged before me on the 17th day of February, 1989, by Ralph Powell, the President of the Board of Directors of HIDALGO AND CAMERON COUNTIES IRRIGATION DISTRICT NUMBER 9, a political subdivision of the State of Texas, on behalf of said political subdivision.

Laverne Miller
Notary Public in and for
The State of Texas

Notary's Printed Name:
Laverne Miller

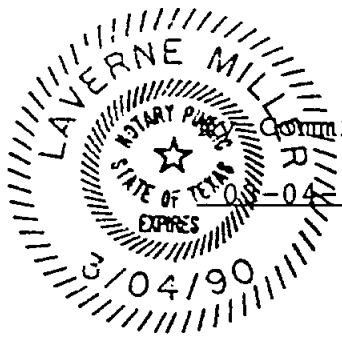

Commission Expires:
3-04-90

STATE OF TEXAS {
 {
COUNTY OF HIDALGO {

This instrument was acknowledged before me on the 9th day of February, 1989, by Armando Cuellar, the Mayor of the CITY OF WESLACO, a municipality in the State of Texas, on behalf of said City.

Martha Ayala
Notary Public in and for
The State of Texas

Notary's Printed Name:
MARTHA AYALA

My Commission Expires:
7/15/89

Item II, (5.4)

PUMP PERFORMANCE CURVES

CURVE NO. 6322-1

PUMP EFFICIENCY

HEAD-CAPACITY

2100 GPM
165' TD

BRAKE HORSEPOWER

U.S. GALLONS PER MINUTE

The pump is guaranteed for the set of conditions specified under the heading of the curve and is guaranteed for FIELD PERFORMANCE shown under the heading of the curve. Capacity, head and efficiency guarantees are contingent on the pump being furnished with the specified amount of clear fresh non-aerated water at a temperature not to exceed 85 degrees Fahrenheit.

FAIRBANKS, MORSE & CO.
P O M O N A W O R K S
P O M O N A • C A L I F O R N I A
DALLAS - HOUSTON REG. 160-24648

FIELD-PERFORMANCE

3 3000 A.C. Fig. 6927
Pump operating at 1750 RPM with
10" Discharge & 5" F. c. 1/2" I.D. col. & St.
FAIRBANKS & CO.

FORM NO. 244 (5-5-54)

Pump # 3

C. F. Dunn

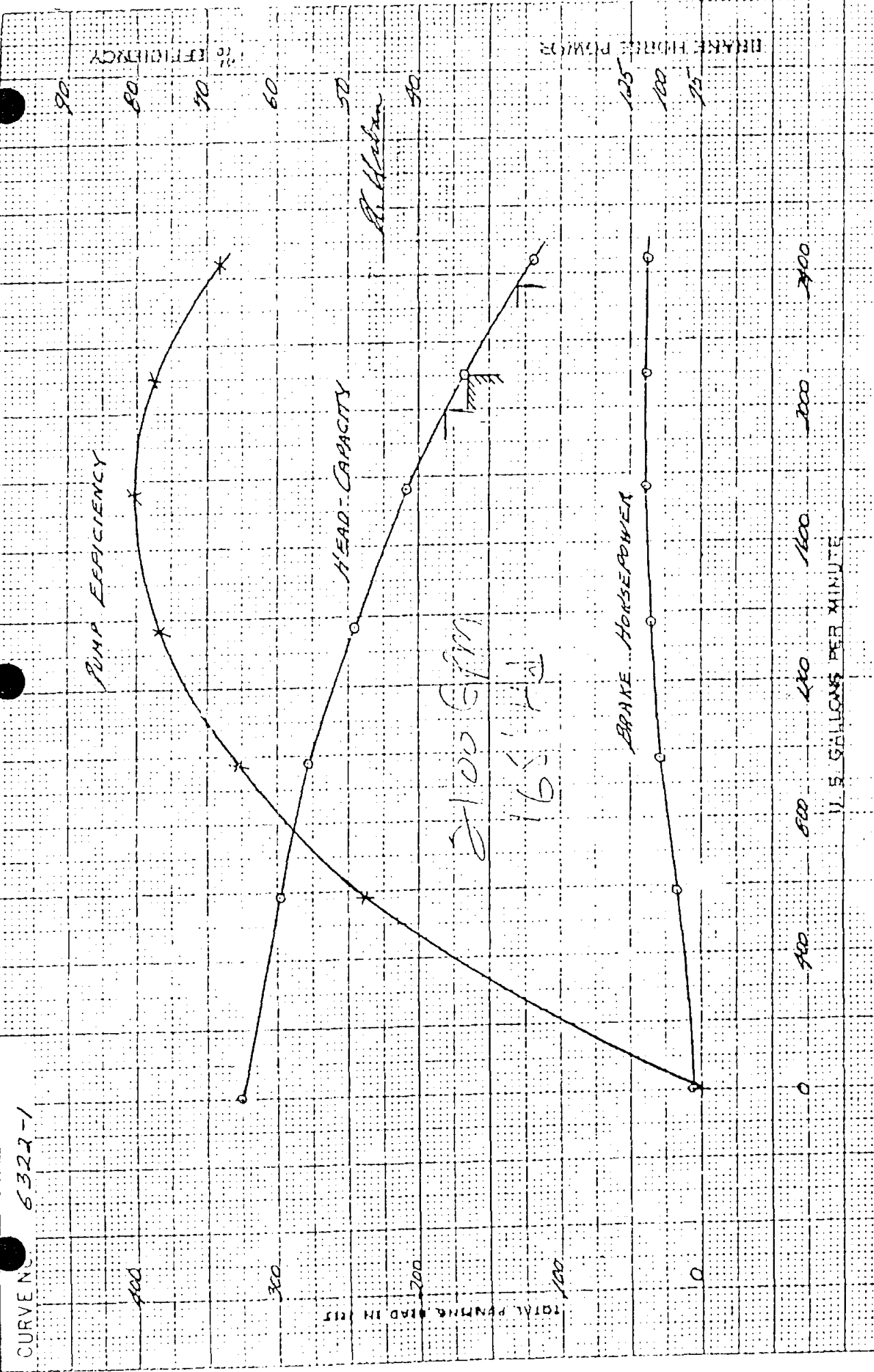

CURVE NO. 6321-1

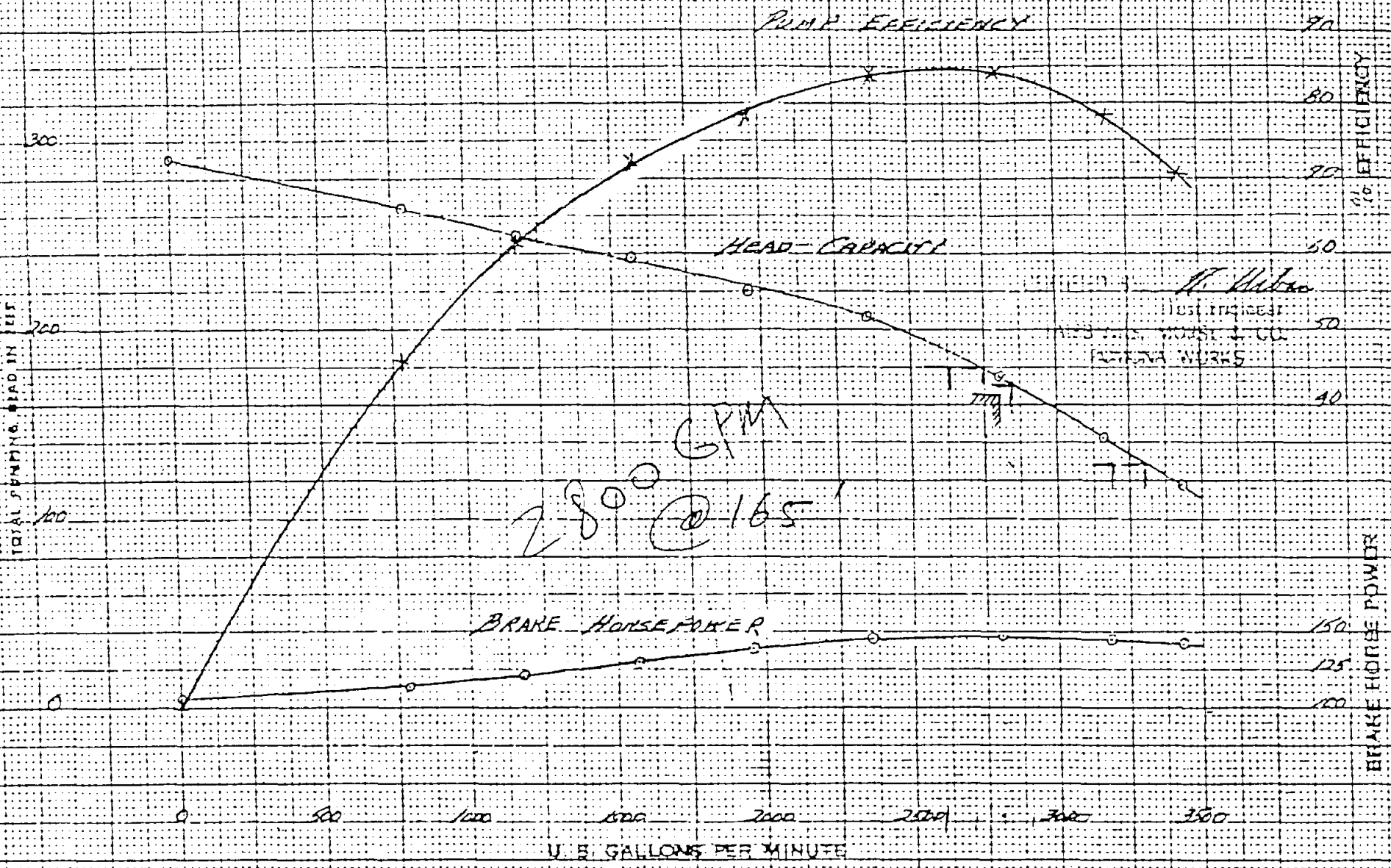

The pump is guaranteed for the set of conditions specified other points on the curve are approximate. The FIELD PERFORMANCE shown makes allowances for hydraulic and mechanical loss in new column, shaft and discharge elbow or head as specified in the title block. Capacity head and efficiency guarantees are contingent on the pump being furnished with the specified amount of clear, fresh, non-aerated water at a temperature of not to exceed 85 degrees Fahrenheit.

8-16-61

FAIRBANKS, MORSE & CO.

P O M O N A W O R K S

P O M O N A • C A L I F O R N I A

DALLAS-HOUSTON REG. 160-24648

FIELD PERFORMANCE

Two Stage 18" MC Fig. 6927
 Pump operated at 1750 RPM with
 12" Discharge & 5' H. of 12x2 1/2 Col. & Sh.
 FITZGERALD CO., INC. P.D. 5766

ALTERNATE

TURBINE PUMP FIELD PERFORMANCE

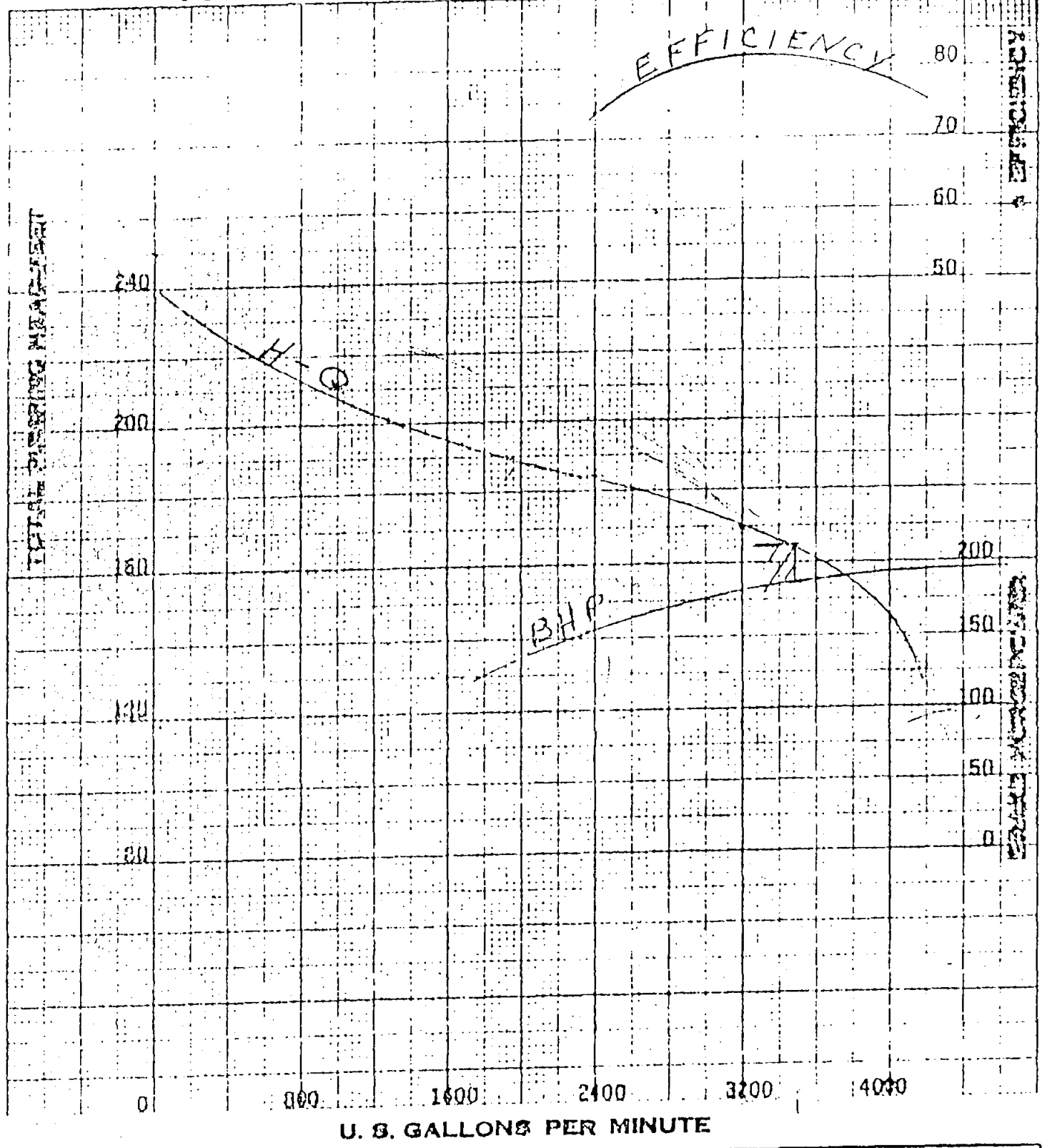

The pump is guaranteed for the set of conditions specified, other points are approximate. The FIELD PERFORMANCE shown makes allowance for hydraulic and mechanical loss in new column, shaft and discharge head or elbow specified above. Capacity, head and efficiency guarantees are contingent on furnishing the pump with the specified amount of clear, fresh non-aerated water at a temperature of not to exceed 85 degrees F.

CUSTOMER: CITY OF WESLACO, TEXAS
 SIGLER, WINSTON & GREENWOOD, ENGINEERS
 TWO STAGE 16KHH FIGURE 1110
 OPERATED AT 1770 RPM WITH 10 FEET
 OF 14" COLUMN AND SHAFT, 14" DISCHARGE
 DRAWN BY: R.M. DATE: 2/16/79

**WATER CONSERVATION AND
EMERGENCY WATER DEMAND MANAGEMENT PLAN
(CURRENTLY BEING MODIFIED/UPDATED - FEBRUARY 1997)**

**WATER CONSERVATION
AND
EMERGENCY WATER DEMAND
MANAGEMENT PLAN**

000062

CITY COMMISSION

GENE BRAUGHT _____ MAYOR
LAZARO CARDENAS, JR. _____ MAYOR PRO TEM
HECTOR DE LA ROSA _____ COMMISSIONER
OSCAR RIOS _____ COMMISSIONER
JOHN F. CUELLAR _____ COMMISSIONER

CITY ADMINISTRATION

FRANK CASTELLANOS _____ CITY MANAGER
JUAN P. FLORES _____ PUBLIC WORKS DIRECTOR
GILBERTO AGUILAR _____ UTILITIES COORDINATOR

PREPARED BY:
**CITY OF WESLACO
ENGINEERING DEPARTMENT
306 S. BRIDGE
WESLACO, TEXAS 78596
(210) 968-3181**

APRIL 1996

Attn: IT (12.7)

TABLE OF CONTENTS

000063

<u>Section</u>	<u>Page</u>
1.0 INTRODUCTION	1-1
1.1 Planning Area and Project	1-2
1.2 Utility Evaluation Data	1-2
1.3 Goals of the Program	1-2
2.0 WATER CONSERVATION PLAN	2-1
2.1 Education and Information	2-1
A. First-Year Program	2-1
B. Long-Term Program	2-1
C. New Customer Program	2-1
2.2 Water Conservation Oriented-Rate Structure	2-1
2.3 Universal Metering and Meter Repair and Replacement	2-3
2.4 Leak Detection and Repair	2-3
2.5 Means of Implementation and Enforcement	2-3
2.6 Annual Reporting	2-4
2.7 Water Conservation Landscaping	2-4
2.8 Pressure Reduction	2-4
2.9 Water Wells	2-5
2.10 Retrofit Program	2-5
2.11 Plumbing Codes	2-5
3.0 EMERGENCY WATER DEMAND MANAGEMENT PLAN	3-1
3.1 Introduction	3-1
3.2 Trigger Conditions	3-1
A. Phase I (Voluntary Conservation Trigger)	3-1
B. Phase II (Mandatory Conservation Trigger)	3-1
C. Phase III (Water Curtailment Trigger)	3-1
3.3 Emergency Water Demand Management Measures	3-2
A. Phase I Voluntary Conservation Trigger (Mild Condition)	3-2
B. Phase II Mandatory Conservation Trigger (Moderate Condition)	3-2
C. Phase III Water Curtailment Trigger (Severe Condition)	3-4
3.4 Information and Education	3-4
3.5 Initiation Procedures	3-5

TABLE OF CONTENTS - Continued

000064

<u>Section</u>	<u>Page</u>
3.6 Termination Notification	3-5
3.7 Implementation	3-5
3.8 Fines	3-6
4.0 LEGAL AND REGULATORY COMPONENTS	4-1
5.0 CONTRACTS WITH OTHER POLITICAL SUBDIVISIONS	5-1
6.0 ANNUAL REPORTING	6-1

1.0 INTRODUCTION

This water conservation plan explains the actions the City of Weslaco will take to implement a water conservation program. The objective of the water conservation program is to reduce the quantity of water required within the service area by implementing efficient water use procedures.

There are many benefits to water conservation, including:

- reducing capital and operating costs for water and wastewater systems;
- postponing the need for new or expanded water or wastewater systems;
- reducing demand on limited water supplies, thereby making them available for future use;
- reducing peak demand on water treatment and distribution systems;
- drought-proofing water systems so that rationing, such as restricting lawn watering, can be avoided, or the need for such measures reduced,
- reducing wastewater flows to wastewater treatment facilities and reducing the potential for water pollution;
- saving citizen's money on their utility bills through reduced water use and associated reductions in energy use.

1.1 Planning Area and Project

The City of Weslaco (the City) is located east of McAllen and west of Harlingen in the Texas Valley area. The City of Weslaco provides water for the City and its Extra Territorial Jurisdiction (ETJ). The City also plans to include various Colonias around the City into its water service area.

The planning area, which includes the City and twenty-eight surrounding colonias. The City currently provides direct water service to In-City residents and residents of the colonias located on the southeast side of the City. Indirect water service is provided to residents of the colonias located to the southwest of the City through a water purchase agreement with Military Highway Water Supply Corporation. The City currently provides wastewater service only to In-City residents. Wastewater service to colonia residents southeast of the City is proposed to be provided from financial assistance available through the Texas Water Development Board's (TWDB) Economically Distressed Areas Program (EDAP).

The overall objective is to determine the wastewater facility needs for the City and the surrounding colonias and to develop options for providing long-term wastewater treatment solutions and collection system infrastructure development. This section describes water conservation and emergency water demand management measures that could have an impact on projected water supply demands and associated wastewater generation throughout the planning area.

1.2 Utility Evaluation Data

Appendix A contains the TWDB's Municipal Water Conservation Planning Data: Utility Survey. The information on this survey provides a consistent format of the information and data needed to develop the Water Conservation and Emergency Water Demand Management Plan (the Plan). The data provides the information needed to established conservation goals.

1.3 Goals of the Program

To develop a long-term water conservation plan, needs must be identified and goals established. A system water audit will be required to determine unaccounted-for water volumes and probable causes of losses. Peak, maximum day, and average water usage information will be monitored in addition to per capita usage.

The current per capita water usage of 150 gpcd (gallons per capita per day) must be reduced to 110 gpcd. The current estimated water losses are approximately 40%. To achieve the priority goal of 27% reduction in per capita usage and to reduce the current estimated water losses, the following phases are set as goals of Plan:

2.1 Education and Information

The City will promote water conservation by informing the public of methods to conserve water. The overall public education program will be divided into three segments: a first-year program, a long-term program, and a new program.

A. First-Year Program

The first-year program will include the distribution of educational materials including brochures and/or newsletters to all customers each quarter. The first information to be distributed will explain the water conservation program. This initial distribution will be accompanied by a newspaper feature article. A school program and seminars will be instituted to supplement the written newsletters and brochures.

The educational materials and news releases will promote water conservation by informing water users about ways to save water inside homes, in landscaping and lawn uses, and in recreational uses.

B. Long-Term Program

The long-term program will include semi-annual distribution of educational materials and new releases corresponding to peak demand periods. The new releases will be used to provide information on water conserving practices, encourage water conservation and report progress on achieving the City's water conservation goal. Other news releases may be used if conditions warrant. A school program and seminars will be instituted to supplement the written newsletters and brochures.

C. New Customer Program

New customers will receive the conservation education material that describes the conservation program and other general conservation information when they apply for service. These customers will then be included in the first-year or long-term program as appropriate. The new customers, who do not have the ability to understand the educational material, will be encouraged to attend the seminar program.

2.2 Water Conservation Oriented-Rate Structure

The City will analyze their current water rate structure to encourage water conservation. The water rate structure will provide additional costs to high volume users.

The current rate structure is as follows:

The City currently bills a minimum charge per month based on the water meter size. In addition to the minimum charge, a usage charge based on gallons consumed is added to the monthly bill.

<u>METER SIZE</u>	<u>CHARGE</u>	
	<u>INSIDE</u>	<u>OUTSIDE</u>
1" Meter on 2" Line	\$ 272.96	\$ 409.44
1" Meter on 12" Line	\$ 375.29	\$ 562.94
1 1/2" Meter on 4" Line	\$ 626.93	\$ 940.40
1 1/2" Meter on 18" Line	\$ 913.38	\$1,370.07
2" Meter on 4" Line	\$ 776.45	\$1,164.65
2" Meter on 18" Line	\$1,062.88	\$1,594.32
3" Meter on 4" Line	\$1,634.28	\$2,451.42
3" Meter on 18" Line	\$1,931.78	\$2,897.67

Residential Inside City Limits.

A.	Minimum monthly bill	\$ 7.00
B.	Minimum monthly bill - SECOND METER	\$ 3.50
	Charge per each 1,000 gallons or portion	\$ 1.40

Residential outside City Limits.

A.	Minimum monthly bill	\$11.50
	Charge per each 1,000 gallons or portion	\$ 1.40

Commercial Users.

	0 to 15,000	\$ 1.40
	15,000 gallons and over	\$ 1.59

The proposed rate structure is as follows:

The proposed rate structure is currently being produced. A copy of the ordinance will be come an attachment to this plan.

2.3 Universal Metering and Meter Repair and Replacement

A water meter replacement program is currently underway in the City of Weslaco. Many meters were broken or not registering correctly. Therefore, the City has decided to replace all meters within their service area.

The ongoing program will continue to meter all water uses and provide for periodic meter testing and replacement. All master meters and meters larger than 1" will be tested annually. Residential water meters will be replaced after one million gallons or 10 years, whichever ever comes first.

2.4 Leak Detection and Repair

The City of Weslaco will perform an annual water audit to determine overall unaccounted-for water loss. The City will also perform a continuous leak detection, location, and repair program to conserve water.

Sources of unaccounted-for water which require quantification include:

- Defective hydrants
- Abandoned services
- Fire Fighting water use
- Inaccurate meters
- Hydrant flushing
- Illegal hookups and water usage
- Water main leaks

The city is currently replacing small diameter galvanized piping within the system. As a goal of this plan, the City will replace the following minimum footage of defective piping:

Year Ending	Replacement (ft)	Extensions
1996	3,000	5,500
1997	3,500	7,000
1998	2,500	4,000
1999	3,000	5,852

2.5 Means of Implementation and Enforcement

The City Manager of Weslaco or a duly appointed representative will act as the Administrator of the Water Conservation Plan. The Administrator will be charged with the execution and implementation of the Plan and be responsible for maintaining all records and information.

The City will also provide the following document to implement the Water Conservation Plan:

- A Resolution adopting this Water Conservation Plan.
- An ordinance to implement the legal document necessary to enforce this Water Conservation Plan.
- A City Plumbing Code reflecting water conservation procedures.
- A city committee to renew impact and revision to the Water Conservation Plan.

2.6 Annual Reporting

In addition to the responsibilities described above, the Administrator will be responsible for the submission of an annual report to the Executive Administrator of the Texas Water Development Board within 60 days of the anniversary date of the loan closing, throughout the life of the loan, this report will include the following elements:

- Progress made in the implementation of the program
- Response to the program by the public
- Quantitative effectiveness of the program

2.7 Water Conservation Landscaping

The public education program will include suggestion on landscaping and irrigation procedures which will result in reduced water consumption and reduced water bills. These practice will be implemented as much as possible on public grounds in order to set an example for the general public. The City's efforts include Xeriscape Landscaping of portions of downtown park area. This will serve as a model to the rest of the residents. Nurseries and other businesses that sell outdoor plants, grasses, and irrigation equipment will be encouraged to make products that conserve water available to the public.

2.8 Pressure Reduction

Pressure is the force which determines how much water can pass through a given faucet, valve, pipe, or hole in a given time. For example, tests for one type of faucet showed that flow rates through the faucet opened at a constant setting varied from 3.0 to 5.6 gallons per minutes at 80 psi. From this example, it is obvious that pressure reduction will help save water by reducing the amount of water that will flow through an opened valve or faucet in a given time. Pressure reduction also saves water by reducing excessive mechanical stress on plumbing fixtures and appliances and on distribution systems. Faucet seats and washers will last longer, washing machine and dishwasher valves will break less frequently, pipe joints will be less susceptible to failure, and leaks in distribution systems will lose water more slowly at lower pressures. For these reasons, the City will provide pressure reducing valves, at no cost to the individual resident, to limit the maximum pressure to 60 psi.

2.9 Water Wells

000071

Water wells will not be permitted for personal use under no circumstances. The City of Weslaco is the only Entity entitled to dig or construct water wells for the citizens of Weslaco.

2.10 Retrofit Program

Customers that do not have water conserving plumbing devices will be encouraged to retrofit their old fixtures. The educational and advertising program will inform them of the advantages of installing water saving devices and the availability of these items. The City will provide water-saving kits at either no-cost to its residents. The State may provide partial funding for these kits.

2.11 Plumbing Codes

The single most effective method of conserving water inside the home is to replace older, inefficient plumbing fixtures with modern, efficient fixtures. Until 1991, Texas did not have statewide legislation to require that water-efficient fixtures be used. This meant that the only effective method of requiring the use of such fixtures was through local plumbing codes. In Texas, however cities of less than 5,000 population were not required to have plumbing codes. This means that a sizable portion of the state's population lived in areas that were without any type of plumbing fixtures. Consequently, the 72nd Texas Legislature passed legislation requiring that plumbing fixtures sold in Texas after January 1, 1992 must meet the following standards:

Fixture	Standard
Shower Heads	No more than 2.75 gallons per minute at 80 pounds per square inch of pressure (psi).
Lavatory and Sinks	No more than 2.2 gallons per minute at psi.
Wall-mounted, Flushometer Toilets	No more than 2.0 gallons per flush.
All other toilets	No more than 1.6 gallons per flush.
Urinals	No more than 1.0 gallon per flush.
Drinking Water Fountains	Must be self-closing.

These standards will be enforced through requirements placed directly on the manufacturers, importers, and suppliers of new fixtures in Texas and will not necessarily require the amendment of the existing plumbing code.

The City of Weslaco will adopt provisions requiring (1) insulation of hot water pipes, (2) installations of pressure reduction valves where system pressures exceed 60 pounds per square inch, (3) installation or recirculating filtration equipment in all new swimming pools, and (4) all ornamental fountains recirculate water.

3.1 Introduction

Drought or other rapidly developing emergency conditions can disrupt the normal availability of the water supply. Even though there may be an adequate water supply, the supply could become contaminated or a disaster could destroy all or part of the system. Also, during drought periods, consumer demand is often significantly higher than normal. System treatment, storage, or distribution failures can also present an emergency demand management situation.

In making decisions under this article concerning the allocation of water between conflicting interests, highest priority will be given to allocation necessary to support human life and health; the minimum amount of water necessary for drinking, prevention of disease. Second highest priority will be given to allocations that will result in the lost of employment to persons whose income is essential to their families.

This section contains procedures and guidance for an emergency water demand management plan. It is important to distinguish emergency water demand management planning from water conservation planning. While water conservation involves implementing permanent water-use efficiency, emergency water demand management plans establish temporary methods or techniques designed to be used only as long as an emergency exists.

3.2 Trigger Conditions

(A) Phase I - (Voluntary Conservation Trigger)

When the level of U.S. water stored in Amistad and Falcon Reservoirs reaches 51% or 1.66 MAF, phase voluntary stage of the Rio Grande Valley Water Conservation plan will be put in effect.

This phase consists of voluntary water conservation action to be taken by the general public, governmental agencies and all water users of waters from the Rio Grande Valley below Amistad and Falcon Dams on the Rio Grande. Customers of the municipal water systems in the Valley shall be requested to voluntarily conserve and limit the use of water.

(B) Phase II - (Mandatory Conservation Trigger)

When the level of U.S. water stored in Amistad and Falcon Reservoirs reaches 25% or 834,600 A/F, mandatory conservation will be declared.

This phase consists of mandatory restrictions of the use of water and imposing of penalties and sanctions for violations of set restrictions.

(C) Phase III - (Water Curtailment Trigger)

When the level of U.S. water stored in Amistad and Falcon Reservoirs reaches 15% or 504,600 A/F, this phase will be implemented.

This phase reduces the maximum amounts of monthly water usage for residential and non-residential customers and imposes surcharges, service cut-offs and other sanctions for violations.

3.3 Emergency Water Demand Management Measures

The following measures will be implemented when the specific trigger conditions are reached. The measures for each level of severity will include continued implementations of relevant requirements and actions imposed under the preceding level.

(A) Phase I Voluntary Conservation Trigger (Mild Condition)

- Inform the public through the news media that a trigger condition has been reached, and that they should look for ways to voluntarily reduce water use. Specific steps which can be taken will be provided through the news media.
- Notify major water users of the situation and request voluntary water use reductions.

(B) Phase II Mandatory Water Conservation (Moderate Condition)

1. The sprinkling or watering of lawns is prohibited; provided, however, the city manager may authorize watering of vegetation as follows:

- (i) The watering of trees; shrubbery; gardens, vegetables and flowers may be permitted through the means of a hand-held hose equipped with a positive shutoff nozzle, a drip irrigation system, a hand-held bucket or watering can, or a sprinkler system which is either attended throughout its use or is equipped with an automatic shutoff.
- (ii) The watering of lawns may be permitted once every seven (7) days through the means of a hand-held hose equipped with a positive shutoff nozzle, a drip irrigation system, a hand-held bucket or watering can, or a sprinkler system which is either attended throughout its use or is equipped with an automatic shutoff. When unauthorized, such lawn watering shall be permitted only on Mondays between the hours of 6:00 a.m. and 9:00 a.m. and 6:00 p.m. and 9:00 p.m.
- (iii) Commercial nurseries shall be exempted from the prohibition of this subparagraph and shall be permitted to water nursery stock by means of a hand-held hose equipped with a positive shutoff nozzle, a drip irrigation system, a handheld bucket or watering can or a sprinkler system which is attended throughout its use, is equipped with an automatic shutoff or recaptures and recirculates irrigation water.
- (iv) The allowing of water to run off yards or plants into gutters or streets shall be deemed a waste of water and is prohibited.

2. The washing of automobiles, trucks, trailers, boats, airplanes and any other type of mobile equipment except that individuals may wash their private cars or boats if they use a bucket, pail, or normal sized receptacles, and further provide, that filling stations shall wash their customers' cars with a bucket, pan, pail or other receptacles not larger than of five-gallon capacity; however, an individual or filling station, after such washing, shall be permitted to rinse the car or boat off with a hose, using only a reasonable amount of water in so doing. Commercial or automatic car wash establishment shall use minimum practical water settings.

3. The washing of building exteriors and interiors, trailers, trailer houses and railroad cars, except that in the interest of public health the city engineer may permit limited use of the water as the case may be.

4. The permitting or maintaining of defective plumbing in a home, business establishment or any location where water is used on the premises. The permitting of the wasting of any water by reason of defective plumbing as hereinabove mentioned shall include the existence of out-of-repair water closets, underground leaks, defective faucets and taps. The permitting of water to flow constantly through a tap, hydrant, valve or otherwise by any user of water connected to the city system, shall be considered as a wasting of water and prohibited by this article.

5. The use of fire hydrants for any purpose other than fire-fighting is prohibited; except that the city manager may permit the use of metered fire hydrant water by the city or by commercial operators using jet rodding equipment to clear sanitary and storm sewers.

6. The use of water in ornamental fountains or in artificial waterfalls where the water is not reused or recirculated in any manner.

7. The use of water to wash down any sidewalks, walkways, driveways, parking lots, tennis courts or other hard-surfaced area, building or structure.

8. The use of water for dust control.

9. The use of potable water by a golf course to irrigate any portion of its grounds except those areas designated as tees and greens and only between the hours of 6:00 a.m. and 9:00 a.m. on the designated watering days.

10. Any use of water for the purposes or in a manner prohibited in this section shall be deemed to be a waste of water and any person violating any of the provisions of this article and any person in whose name a water meter connection is registered in the water department which water connection serves premises upon which a violation occurs, and proof that the particular premises have a water meter connection registered in the name of the defendant named in the complaint, shall constitute in evidence a prima facie presumption that the person in whom such water connection was registered was the person who permitted or caused the act of waste charged to occur on the premises.

11. Concurrently with the implementation of CONDITION II, the city council shall appoint an allocation and review committee, as hereinafter provided, for the purpose of reviewing water conservation policies and establishing exemptions.

Item V. (12.)

1. New service connections to the city's water system are prohibited where some other source independent of the city's water system is existing and in use at the time of passage of this article.
2. The use of water to serve a customer in a restaurant unless requested by the customer is prohibited.
3. The use of water for the expansion of commercial nursery facilities is prohibited.
4. The use of water for scenic and recreational ponds and lakes is prohibited.
5. The use of water for private, single-family residential swimming, wading, and Jacuzzi pools, hot tubs and like or similar uses is prohibited.
6. The use of water for municipally owned swimming pools is prohibited.
7. The use of water for privately owned neighborhood and subdivision swimming pools accessible to the public and swimming pools owned by country, athletic, and health clubs, fraternal organizations and other like or similar pools is prohibited.
8. The use of water for hotel, motel, condominium, apartment and other multifamily, residential-user swimming pools, including commercial and business swimming pools is prohibited.
9. The use of water to put new agricultural land into production is prohibited.
10. The use of water for new planting or landscaping is prohibited.
11. No applications for new, additional, further expanded, or increased-in size water service connections, meters, service lines, pipeline extensions, mains, or other water service facilities of any kind shall be allowed, approved, or installed except as approved by the allocation and review committee.
12. All allocations of water use to industrial and commercial customers in amounts as established after consultation with the allocation and review committee.
13. The maximum monthly use for a residential customer be established with revised rate schedules and penalties by the city council on recommendation by the allocation and review committee.
14. The city council and city manager shall take those actions deemed necessary to meet the conditions resulting from the emergency.

3.4 Information and Education

The public will be informed of what will be expected during a drought or emergency situation. The public will be informed about the content and purpose of the emergency water

demand management plan before the onset of any emergency condition. The information ⁰⁰⁰⁰⁷⁷ describe trigger conditions and emergency measures, and the need to implement the measures in the event of an emergency. The methods of education and informing the public will include the following:

- public meeting;
- radio and television public service announcements and news stories;
- newspaper articles;
- letters, bill inserts or messages, and brochures to water customers; and
- use of volunteer groups to promote water conservation practices.

3.5 Initiation Procedures

The City will provide adequate methods of informing its customers, as far in advance as possible that a trigger condition is being approached or has been reached, and that a certain phase of the emergency water demand management plan must be implemented. The written procedures include:

- posting of a notice at the Weslaco City Hall;
- media notification of the notice;
- direct notification procedures including mail or, if needed, telephone notification systems.

3.6 Termination Notification

The City will inform its customers that the emergency has passed when the trigger condition have subsided. The public will be informed of the termination in the same manner that they were informed of the initiation of the measures. This notification also includes a change in condition, whether up or down.

3.7 Implementation

The primary reason for developing this plan is to have a guide for implementing an emergency water demand management program if the need occurs. It is the intent of the City to develop a workable plan that customers understand and which can be implemented if needed. The Mayor or other duty designated representative will be authorize by the City Council to order the initiation of the emergency water demand management plan procedures. In order to accomplish this, the City has adopted an ordinance to implement the Water Conservation and Emergency Water Demand Management Plan.

To implement the requirements of this plan, the following steps will be followed to address those individuals who are not complying with the plan.

Step 1: Verbal communication instructing the party to discontinue non-compliance.

Step 2: If non-compliance continued, send a Certified Letter instructing the party to discontinue non-compliance and informing them they are subject to fines and removal of water service.

Step 3: If non-compliance continues, assess fines according to the City Ordinance instituting this plan. 000078

Step 4: If non-compliance continues, and the fines are not paid, the City will disconnect the water service and a reconnect fee will be required to re-institute the service.

3.8 Fines

The City Ordinance shall allow for fines with a minimum fine of \$200.00 to a maximum fine of \$500.00.

4.0 Legal and Regulatory Components

000079

The Ordinance adopting this Water Conservation and Emergency Water Demand Management Plan on the next page.

Item II. (12)

**A 1996 CONSENSUS-BASED UPDATE TO THE
TEXAS WATER PLAN
CITY OF WESLACO POPULATION FORECAST**

PROJECTIONS OF POPULATION AND MUNICIPAL WATER USE
 WATER USE UNITS: ACRE-FEET

COUNTY: 108 HIDALGO

CITY: 638 WESLACO

SERIES	----- HISTORICAL -----		**----- PROJECTED -----**					
	1980	1990	2000	2010	2020	2030	2040	2050
Population	19331	21877						
Water Use	3653	3255						
MIGRATION RATE .0								
Population.....			25127	28500	31811	35268	38100	41159
Normal Rainfall			3575	4054	4525	5017	5420	5855
Below Normal Rainfall			4475	5076	5666	6281	6786	7331
Normal/Expected Conserv.			3378	3575	3741	4030	4225	4564
Below Normal/Expected Con			4250	4533	4775	5175	5463	5855
Normal/Advanced Conserv.			3237	3320	3456	3753	4012	4288
Below Normal/Advanced Con			4081	4214	4347	4780	5079	5440
(With Plumbing Code Only)								
Normal/Expected Conserv.			3434	3735	4027	4346	4566	4887
Below Normal/Expected Con			4334	4757	5167	5610	5932	6362
Normal/Advanced Conserv.			3378	3607	3884	4267	4524	4841
Below Normal/Advanced Con			4278	4629	5024	5531	5889	6316
MIGRATION RATE .5								
Population.....			27214	33506	40411	48834	56437	65224
Normal Rainfall			3871	4767	5749	6947	8029	9279
Below Normal Rainfall			4847	5968	7197	8697	10052	11617
Normal/Expected Conserv.			3628	4166	4708	5525	6259	7160
Below Normal/Expected Con			4573	5292	6020	7111	8092	9279
Normal/Advanced Conserv.			3506	3903	4346	5197	5942	6795
Below Normal/Advanced Con			4420	4917	5522	6564	7523	8621
(With Plumbing Code Only)								
Normal/Expected Conserv.			3719	4354	5070	5962	6701	7744
Below Normal/Expected Con			4694	5555	6518	7713	8724	10082
Normal/Advanced Conserv.			3628	4204	4934	5853	6701	7671
Below Normal/Advanced Con			4603	5405	6383	7603	8724	10009
MIGRATION RATE 1.0								
Population.....			29435	39115	50958	65408	80489	99047
Normal Rainfall			4187	5564	7249	9305	11450	14090
Below Normal Rainfall			5242	6966	9076	11649	14335	17641
Normal/Expected Conserv.			3924	4820	5879	7400	8926	10873
Below Normal/Expected Con			4946	6134	7535	9451	11450	14090
Normal/Advanced Conserv.			3792	4513	5480	6887	8385	10318
Below Normal/Advanced Con			4748	5740	6907	8792	10729	13092
(With Plumbing Code Only)								
Normal/Expected Conserv.			3990	5039	6336	7913	9557	11760
Below Normal/Expected Con			5045	6441	8162	10257	12442	15311
Normal/Advanced Conserv.			3924	4863	6165	7840	9557	11649
Below Normal/Advanced Con			4979	6265	7991	10184	12442	15200
MOST LIKELY SERIES								
Population.....			29435	36241	43710	52820	61044	70548
Normal Rainfall			4187	5156	6218	7514	8684	10036
Below Normal Rainfall			5242	6455	7785	9407	10872	12565
Normal/Expected Conserv.			3924	4506	5092	5976	6769	7744
Below Normal/Expected Con **			4946	5683	6512	7692	8752	10036
Normal/Advanced Conserv.			3792	4222	4700	5621	6359	7349
Below Normal/Advanced Con			4748	5318	5973	7100	8137	9325
(With Plumbing Code Only)								
Normal/Expected Conserv.			3990	4709	5435	6449	7248	8377
Below Normal/Expected Con			5045	6008	7001	8342	9436	10905
Normal/Advanced Conserv.			3924	4547	5337	6331	7248	8298
Below Normal/Advanced Con			4979	5846	6904	8224	9436	10826

**TWDB'S COMMENTS ON THE
DRAFT FINAL REPORT**



TEXAS WATER DEVELOPMENT BOARD

William B. Madden, *Chairman*
Charles W. Jenness, *Member*
Lynwood Sanders, *Member*

Craig D. Pedersen
Executive Administrator

Noé Fernández, *Vice-Chairman*
Elaine M. Barrón, M.D., *Member*
Charles L. Geren, *Member*

February 12, 1997

Mr. James Hiebert
Finance Director
City of Weslaco
500 South Kansas
Weslaco, Texas 78596

Re: Review of the Draft Final Report for the Regional Water Supply and Wastewater Planning Contract Between the City of Weslaco (City) and the Texas Water Development Board (TWDB), TWDB Contract No. 95-483-085

Dear Mr. Hiebert:

Texas Water Development Board staff have completed a review of the draft final report submitted under TWDB Contract No. 95-483-085. As stated in the above referenced contract, the City will consider incorporating comments on the draft final report from the TWDB, shown in Attachment 1, and other commentors into a final report. The City must include a copy of the TWDB's comments in the final report.

The Board looks forward to receiving one (1) unbound camera-ready original and nine (9) bound double-sided copies of the Final Report on this planning project. Please contact Mr. Gary Laneman, the Board's Contract Manager, at (512) 463-8062, if you have any questions about the Board's comments.

Sincerely,

A handwritten signature in cursive script, appearing to read "Tommy Knowles".

Tommy Knowles
Deputy Executive Administrator
for Planning

cc: Gary Laneman, TWDB

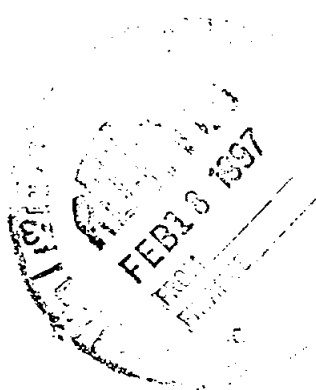

Our Mission

Exercise leadership in the conservation and responsible development of water resources for the benefit of the citizens, economy, and environment of Texas.

P.O. Box 13231 • 1700 N. Congress Avenue • Austin, Texas 78711-3231
Telephone (512) 463-7847 • Telefax (512) 475-2053 • 1-800- RELAY TX (for the hearing impaired)
URL Address: <http://www.twdb.state.tx.us> • E-Mail Address: info@twdb.state.tx.us

♻️ Printed on Recycled Paper ♻️

ATTACHMENT 1

TEXAS WATER DEVELOPMENT BOARD

COMMENTS ON THE CITY OF WESLACO'S REGIONAL WATER SUPPLY AND WASTEWATER PLANNING CONTRACT Contract No. 95-483-085

- 1) The consultant used the TWDB 1989 population projections for the City of Weslaco as the primary population projections for the study. In selecting the TWDB 1989 projections, the consultant reviewed the TWDB 1992 population projections and population projections prepared by Wilbur Smith Associates. TWDB has developed more recent 1994 population projections for the City of Weslaco that should be considered for the study. These new projections were used in developing the update to the State Water Plan in 1996. The 1994 population projections were developed through a consensus process with the Texas Natural Resource Conservation Commission and the Texas Parks and Wildlife Department and are more in line with the TWDB 1992 population projections.
- 2) The TWDB 1994 water requirement projections for Weslaco are lower than the water demands presented in the report due in part to the updated population projections, modified time series for developing planning per capita water use, and more detailed conservation information than was used in developing the previous 1990 projections. The official demands developed for the 1996 State Water Plan should be used for Weslaco.
- 3) The adequacy of cost estimates could not be determined due to lack of detail presented in the report on the development of cost estimates. Please include a more thorough documentation of how cost estimates were developed.
- 4) Different build-out rates were used in the report for water and wastewater. In order to be consistent, the use of the more conservative rate would be more appropriate.
- 5) The year in which a future analysis should be conducted is different for the new water plant and for an analysis of wastewater plant expansion. For continuity and simplicity, the same year should be recommended.
- 6) The estimated wastewater flow generated of 85 gpcpd, which came from a sample of flows generated from October, 1990 to October, 1991, does not contain within its makeup a water conservation component. Wastewater flows generated should be developed based on a systemwide per capita average demand of 150 gpcpd with a conservation component incorporated or a percentage of the demand having a water conservation component.

Regional Water Supply & Wastewater
For The
City Of Weslaco, Texas

Part 1 - Water

Contract No. 95-483-085F

The following maps are not attached to this report. Due to their size, they could not be copied. They are located in the official file and may be copied upon request.

Pressure Contours

Figure 2.5

City of Weslaco,- Water Distribution System Junction
Pressure At Peak Demand (Without Fire Flow Simulation)

City of Weslaco-Water Distribution System Existing System
And Proposed Improvements

Figure 2.8

Please contact Research and Planning Fund Grants
Management Division at (512) 463-7926 for copies.

CHAS. A. GREENWOOD, P.E.
PRESIDENT
WM. R. SHEA, P.E.
EXECUTIVE VICE-PRESIDENT

**SIGLER, WINSTON, GREENWOOD
& ASSOCIATES, INC.**
Consulting Engineers

JOE B. WINSTON, JR., P.E.
SECRETARY
RANDALL C. WINSTON, P.E.
TREASURER

WESLACO, TEXAS 78596-6623 ✕
1604 E. HWY. 83 AC 210-968-2194 FAX 968-8300

MCALLEN, TEXAS 78501 □
801 QUINCE ST., SUITE 15 AC 210-682-1326
(REPLY TO OFFICE INDICATED)

February 28, 1997

Mr. Gary Laneman, P.E.
Texas Water Development Board
1700 N. Congress Ave.
Austin, Texas 78711-3231

**Re: Regional Water Supply and Wastewater Study - Final Report (Part 1 - Water)
City of Weslaco, Texas**

Dear Mr. Laneman:

On February 19, 1997, we received TWDB's comments on the Draft Final Report. As required by TWDB, enclosed please find Nine (9) bound copies and one (1) unbound camera-ready original of the Final Report. The Final Report incorporates TWDB's and City of Weslaco's comments. The Draft Final Report has been revised as follows:

1. Our firm used "High Series Population Projections" (TWDB's 1989 population projections) in the Draft Report. The letter shows that the TWDB released an updated version of the water plan in 1995 (A 1996 Consensus-Based Update to the Texas Water Plan). Also, the letter suggests that we use updated population projections for the future system analyses and recommendations. Please note that, the latest population figures given in the TWDB's "Most Likely Projections" are lower than the figures used in the draft report (i.e. TWDB's High Series figures). Therefore, we feel that we presented the future system analyses and recommendations based on a more conservative approach.
2. In order to save time and effort involved in revising the entire report based on the new population projections, we approached the study as follows: The future distribution system design was maintained as shown in the draft report, whereas the treatment plant capacity requirement for the future conditions was assessed based on both TWDB's Most Likely Series (1996) and High Series Projections (1989). Accordingly, we revised the appropriate sections of the report.
3. The letter asks for an explanation on how the cost estimates were developed. Please note that in Chapter 3, Page 3-1, we stated that the cost estimates were based on the most recent bid tabulations of the Weslaco's water and sewer projects and by consulting various other sources.

Thank you. If you have any questions, please call us at (210) 968-2194.

Sincerely,

Sigler, Winston, Greenwood & Associates

Krishna M. Gobburu, E.I.T.

Randy Winston, P.E.

**CITY OF WESLACO
WATER & WASTEWATER STUDY**

PART I - WATER

TABLE OF CONTENTS

1.0 INTRODUCTION

1. General	1-1
2. Need for the Water Study	1-1
3. Scope of the Study	1-1
4. Financial Assistance	1-1
5. Background	1-2
(A) Study Area	1-2
(B) Topography	1-2
(C) Weslaco Population Projections	1-2
(D) Impact Fee Background	1-2
6. Land Use	1-3
(A) Current	1-3
(B) Future (Year 2010)	1-3
7. Study Approach	1-4

2.0 PRELIMINARY ENGINEERING

1. Service Area	2-1
2. Source of Water Supply & Existing Water Rights	2-1
3. Water Use	2-2
(A) Major Water Users	2-2
4. Population Projections	2-3
5. Water Use Projections	2-5
6. Projected Water System Requirements	2-6
(A) Water Rights	2-6
(B) Water Treatment Plant	2-6
7. Existing Water Treatment Facilities	2-6
(A) Raw Water Reservoir	2-6
(B) Treatment Plant	2-7
8. Water Distribution System	2-7
(A) Clear Well & Storage	2-7
(B) High Service Pumps	2-8
(C) Distribution Lines	2-8
(D) Elevated Storage Tanks	2-8

9. Analyses of Existing System	2-8
(A) Design Criteria - Treatment Plant & Storage	2-8
(B) Design Criteria - Distribution System	2-9
(C) Water Network Model Development	2-10
(D) Computer Model Calibration	2-10
(E) Network Analyses - Current Condition	2-11
10. Network Analyses - Future Conditions	2-12
(A) Performance of proposed system for future conditions (yr 2000, from modeling)	2-13
(B) Performance of proposed system for future conditions (yr 2010, from modeling)	2-13
11. Recommendations	2-13
(A) Distribution Mains	2-13
(B) Water Treatment Plant Improvements	2-13
(C) Storage Requirements	2-14
(D) Miscellaneous	2-14
3.0 COST ESTIMATION OF THE IMPROVEMENTS	
1. Preliminary Cost Estimate	3-1
4.0 PROJECT SCHEDULE & IMPLEMENTATION PLAN	
1. Implementation Plan	4-1
(A) Five Year Schedule of System Improvements	4-1
(B) Potential Funding Sources	4-1
a) State Support (If eligible)	4-1
b) Local Funding	4-2
c) User Fee	4-2
5.0 CONCLUSIONS	5-1

Appendices

- Model Input Existing System - Current Demand
- Junction/Node Demand
- Water Rights Agreement

- Pump Performance Curves
 - Water Conservation & Emergency Water Demand Management Plan
 - A Consensus-Based Update to the Texas Water Plan - City of Weslaco Population Projections
 - TWDB's Comments on the Draft Final Report
-

List of Tables

- 2.1 - Water Consumption Data
- 2.2 - Major Water Users
- 2.3 - Historical and Projected Population Growth for the City of Weslaco
- 2.4 - Water Use Projections - City of Weslaco
- 2.5 - High Service Pumps at the Water Treatment Plant - City of Weslaco
- 2.6 - Existing Elevated Water Tanks - City of Weslaco
- 2.7 - Evaluation of Water System Capacities - City of Weslaco
- 2.8 - Information on Fire Hydrants - City of Weslaco
- 2.9 - Locations of Fire Flow Simulation

- 3.1 - Cost Summary of Proposed Improvements
- 3.2 - Water Distribution System Proposed Improvements

- 4.1 - Priority Schedule of the Proposed Improvements

List of Figures

- 1.1 - Map of Project Study Limits
- 1.2 - U.S.G.S. Contour Map
- 1.3 - City of Weslaco Population, 1930-2010
- 1.4 - Planned 2010 Land Use

- 2.1 - Water Distribution System
- 2.2 - Weslaco Water Treatment Plant and Surrounding Area
- 2.3 - Water Treatment Plant Process Flowchart - City of Weslaco, Texas
- 2.4 - Water Distribution System Pressures Existing System - Current Demand
- 2.5 - Pressure Contours of the Existing System with Current Demand
- 2.6 - Node Pressure W/Fireflow Simulation at Llano Grande Homesites & Bellaire Subd.

- 2.7 - Future Water Distribution System Junction Pressures at Peak Demand
 - 2.8 - Water Distribution System - Existing System & Proposed Improvements
 - 2.9 - Projected Treatment Plant Capacity - City of Weslaco
-

CHAPTER 1

INTRODUCTION

1. General

The City of Weslaco, Texas, is a rapidly expanding area of Hidalgo County. Weslaco is located in the Rio Grande valley. The City enjoys hot and long summers and short winters, and like other Cities in the valley attracts a significant number of winter Texans. It is estimated that about 5,000 winter Texans make Weslaco as their temporary home town during the months of December thru March. State Highway 83 runs through the heart of Weslaco. Due to this and also due to the arrival of NAFTA, the City recently attracted many commercial establishments. Proximity to US-Mexican border also contributed for the City's growth in the past and will contribute to the growth in future.

2. Need for the Study

The rapid growth of the City raises many concerns, especially about the capacity of the City's existing facilities such as water, wastewater, and drainage. Although, drainage issues were addressed previously, to certain extent, by drainage master plan, there are no significant studies conducted to determine the capacity of the existing water and wastewater facilities both for present and future developed conditions. Therefore it was determined by the City of Weslaco, that an Engineering Study be conducted on the water and wastewater systems that currently serve the City.

3. Scope of the Study

In 1994, the City hired Sigler, Winston, Greenwood & Associates (SWGA) to perform the study. The scope of the study includes evaluation of existing water and wastewater systems for present flows and for flows of year 2010, recommendation of improvements, cost estimation of proposed improvements, and overall conclusions. All these items are discussed in a greater detail in the following chapters.

4. Financial Assistance

This study is sponsored jointly by the Texas Water Development Board (TWDB) and the City of Weslaco. The amounts of funding are as follows:

TWDB	\$ 26,800 (through State Revolving Loan Program (SRF))
City of Weslaco	\$ 26,800 (General revenue and revenue from utility rates)
TOTAL	\$ 53,600

5. Background

A. Study Area

The geographical area encompassed by this planning study includes the City of Weslaco and approximately 15.2 square miles of surrounding territory. The study area extends to Mile 11 N to the north, Mile 7 W to the West, Main Floodway to the South, and Mile 2 ½ W to the East. Figure 1.1 shows limits of the study area.

B. Topography

The topography of the City and surrounding areas is relatively flat with an approximate 1 ft/mile elevation fall to the Northeast. The elevation above MSL varies from 80 feet around South and Southwest to 75 feet around North and Northeast. Figure 1.2 shows the elevation contours of the City and its surrounding areas derived from U.S.G.S. Quad maps.

C. Weslaco Population Projections

A study, "Weslaco Tomorrow", performed by Wilbur Smith Associates in 1990, identifies the historical growth of the City's population. The study also included projected population through year 2010. The growth pattern, both past and future, is shown in the Figure 1.3. This figure was adjusted from current U.S. Census data. Figure 1.3 also includes population projections obtained from TWDB's Water Plan. As it can be seen in the figure, population of Weslaco increased significantly in the last two decades and it is expected to continue in the future. A more detailed discussion on population projections is given in Chapter 2.

D. Impact Fee Background

Impact fee means a charge or assessment imposed by a political subdivision against new development in order to generate revenue for funding or recouping the costs of capital improvements of facility expansions necessitated by and attributable to the new development. Chapter 395 of Texas Municipal Code addresses procedures to be followed in determining impact fees for roadway facilities; water supply, treatment and distribution facilities; wastewater collection and treatment facilities; and storm water, drainage, and flood control facilities. The City may enact or impose an impact fee on land within its boundaries or Extra Territorial Jurisdiction (ETJ) only by complying with Chapter 395. The City may contract to provide capital improvements, except roadway facilities, to an area outside its corporate boundaries and ETJ and may charge an impact fee under the contract, but as noted, if an impact fee is charged in that area, the City must comply with Chapter 395.

It should be noted that the impact fee may only be applied to "New Development." Cost necessary to improve or upgrade existing facilities to serve existing needs are not eligible under Chapter 395.

An impact fee may be imposed only to pay the costs of constructing capital improvements or facility

MAP OF PROJECT STUDY LIMITS

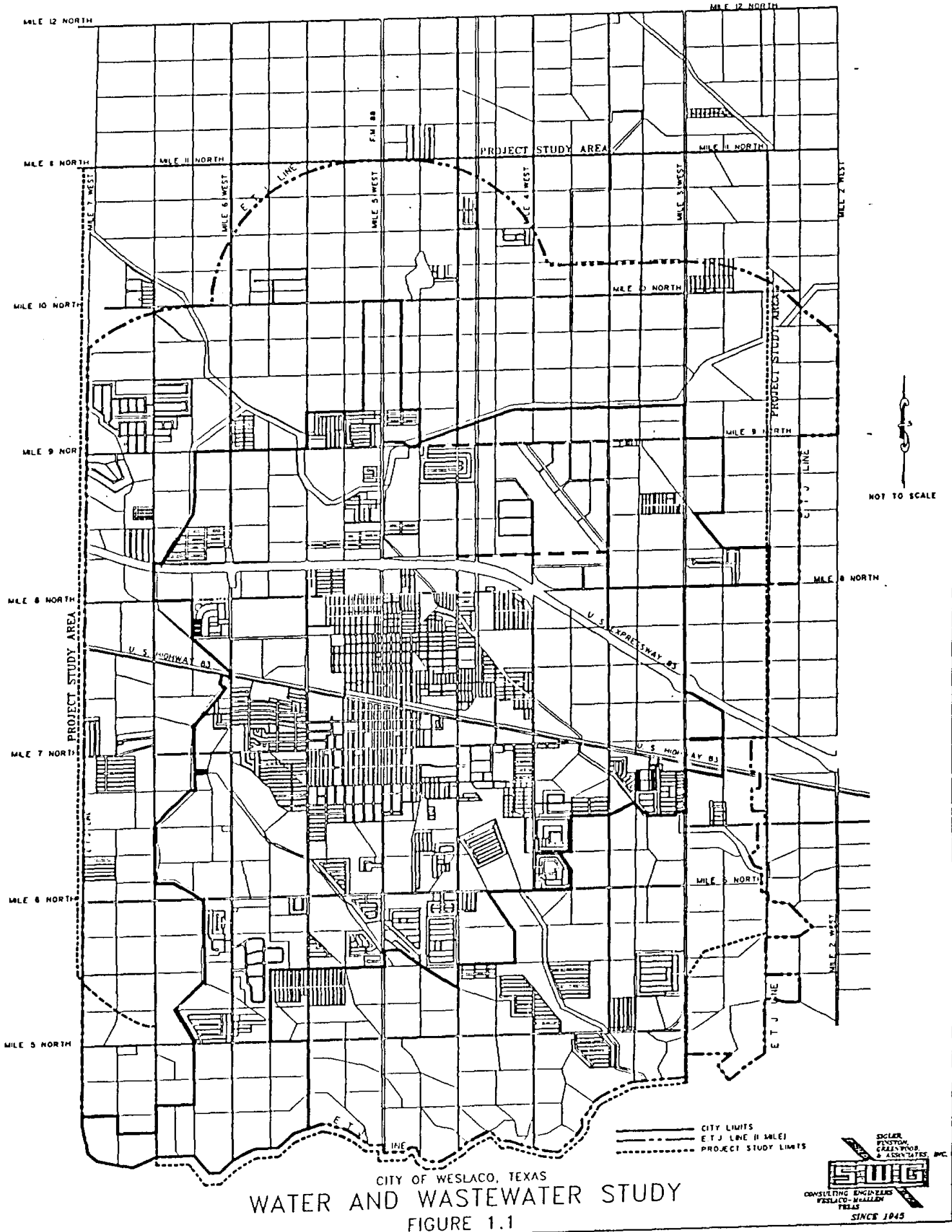

CITY OF WESLACO, TEXAS
WATER AND WASTEWATER STUDY
 FIGURE 1.1

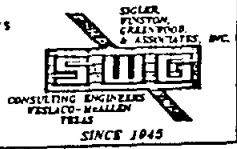

CITY OF WESLACO POPULATION 1930 TO 2010

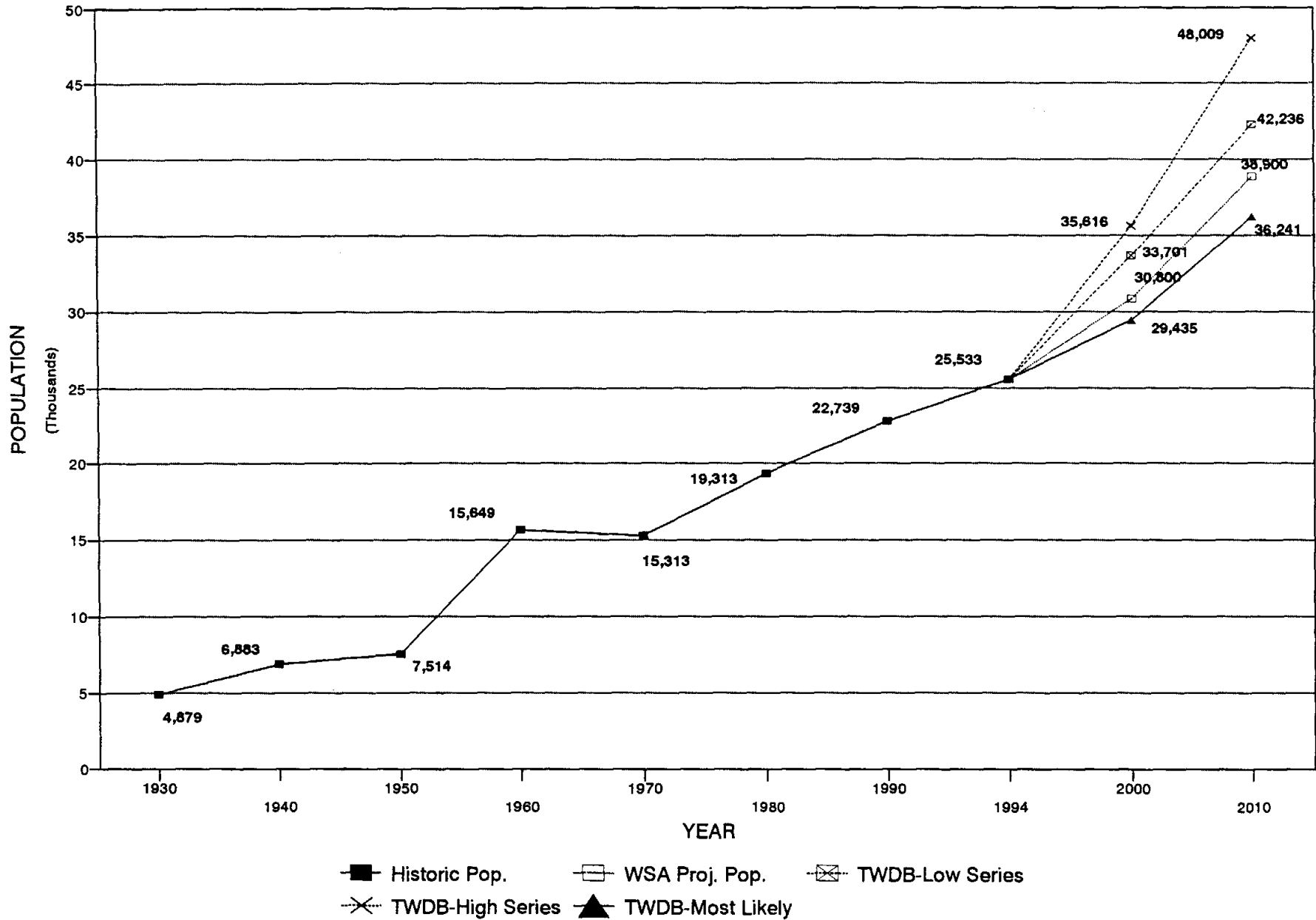

Source: "Weslaco Tomorrow", a study by Wilbur Smith Associates(WSA); City of Weslaco EDAP Report; TWDB Water Plan

FIGURE 1.3

expansions, including and limited to the:

1. construction contract price
2. surveying and engineering fees
3. land acquisition costs, including land purchases, court awards and costs, attorney's fees, and expert witness fees; and
4. fees actually paid or contracted to be paid to an independent qualified engineer or financial consultant preparing or updating the capital improvements plan who is not an employee of the political subdivision.

The City of Weslaco may choose to collect impact fee for the proposed improvements that are discussed in this report. The costs for proposed improvements can be recouped by imposing impact fee to the new developments in the City. The impact fee per service unit may not exceed the amount determined by dividing the cost of the capital improvements by the total number of project service units. If the number of new service units projected over a reasonable period of time is less than the total number of new service units shown by the approved land use assumptions at full development of the service area, the maximum impact fee per service area unit shall be calculated dividing the costs of the part of the capital improvements necessitated by and attributable to project new service units by the projected new service units.

6. Land Use

A. Current

The residential growth is concentrated in South and North of the city and commercial and industrial developments exist along the Expressway 83, and U.S. Highway 83. A major part of the Northeast sector of the city is covered by farmlands. According to the study performed by Wilbur Smith Associates, Weslaco's park system consists of a few larger parks as opposed to several smaller parks. The study also identifies that there is currently a deficit of approximately 70 acres of parkland in Weslaco.

B. Future (Year 2010)

The study performed by Wilbur Smith Associates in 1990 is used for identifying the future land use of the City. According to the report, the majority of the residential growth is expected to occur in the South, Southeast and North areas of the City and its ETJ. Commercial growth will be concentrated in along U.S. HWY. 83 and along FM 1015. Future industrial growth should occur in the vicinity of the Mid-Valley Airport and Industrial Park, which is part of Foreign Trade Zone 156. Development of additional parks and recreation areas should accompany future residential growth, particularly in the North, South and Southeast areas of the City and its ETJ. A map showing the

future land use, for the year 2010, is included in this report as Figure 1.4.

7. Study Approach

A two-part approach is used in the Study. Part One identifies City's water facility needs for both current and future conditions (yr. 2010) and Part Two identifies City's wastewater facility needs for current and future conditions. As mentioned earlier, future land use projections were derived from "Weslaco Tomorrow Plan".

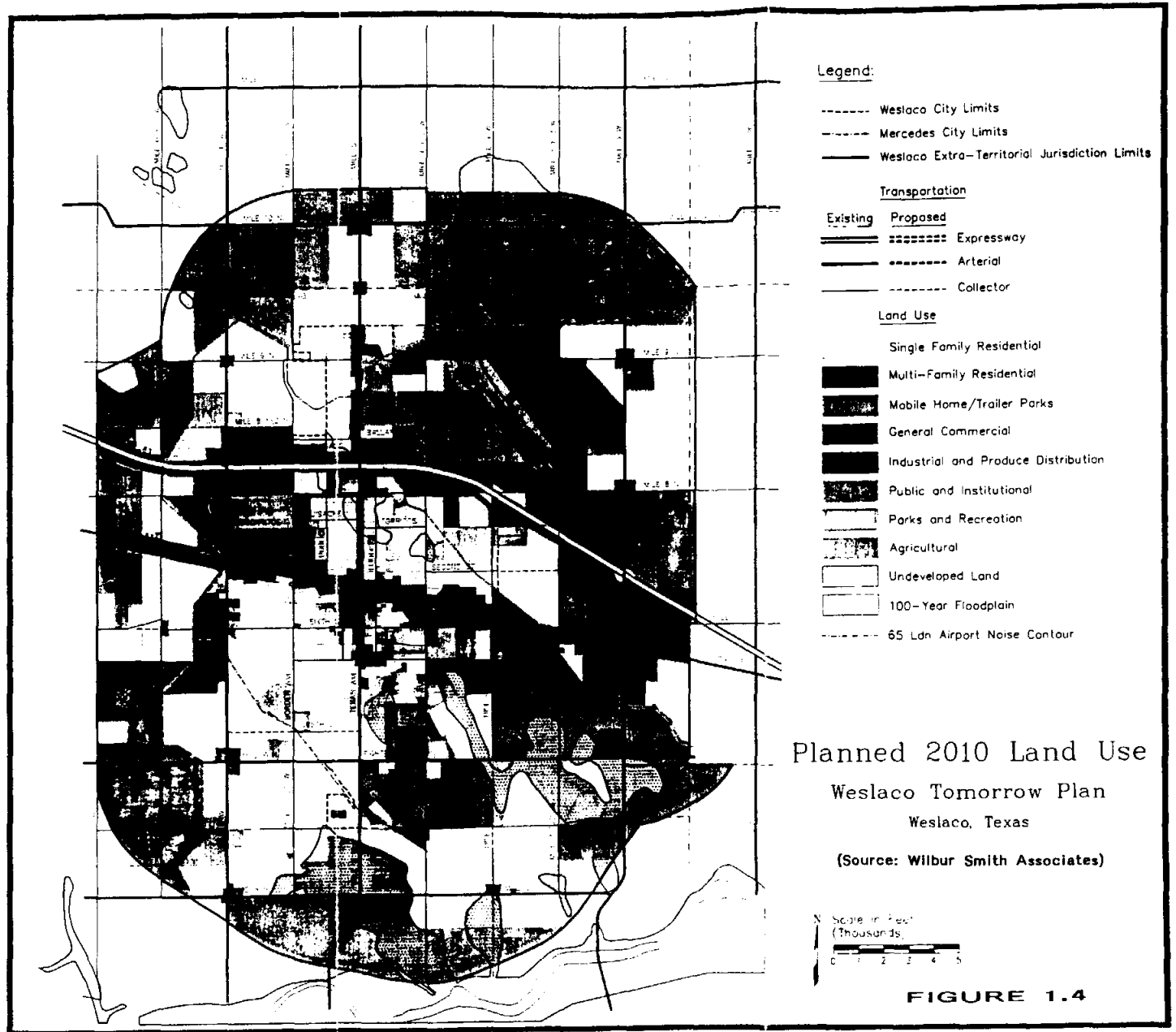

CHAPTER 2

PRELIMINARY ENGINEERING

1. Service Area

The City is authorized by the Texas Natural Resources Conservation Commission (TNRCC) to provide water service to a majority of the project study area (PSA). Portions of the PSA, however, fall under multiple certifications. North Alamo Water Supply Corporation (NAWSC) provides water service to the West, Northwest, and Northern portions of the PSA (CCN No. 10553), while Military Highway Water Supply Corporation (MHWSC) provides water service to the Southwest portion of the PSA (CCN No. 10551). As a result, each of the water supply corporations overlaps the City's service area to some extent. The City's water CCN (No. 10568) currently extends up to Mile 9 ½ N on the North side. Figure 2.1 illustrates the approximate CCN boundaries of the aforementioned certificated entities.

2. Source of Water Supply & Existing Water Rights

The City obtains its water from the Hidalgo and Cameron County Irrigation District No. 9 (District No. 9) which obtains its water from the Rio Grande. The City's point of withdrawal is the City's water treatment plant located at the intersection of Texas Boulevard and Mile 9 North, in the North central portion of the City. A pump station pumps untreated water from the reservoir through a single 20-inch diameter pipeline into the Water Treatment Plant.

The Valley Water Suit Judgment, which became final in 1971, affirmed a water allocation of 5,240 acre-feet per year to the City of Weslaco from District No. 9, as further evidenced by Certificate of Adjudication No. 23-812, issued by the TWC to District No. 9. An additional 1,954.43 acre-feet per year has subsequently been allocated to the City by contract with District No. 9. Thus, the City currently has a total water allocation of 7,194.43 acre-feet per year (approximately 6.423 MGD) from District No. 9. Additional water may be allocated to the City as the City annexes irrigable agricultural land within District No. 9. When the City annexes irrigable agricultural land within District No. 9, the City automatically acquires 1.25 acre-feet per year per acre of annexed land; however, the City also acquires a pro rata share of the District No. 9 indebtedness associated with the annexed land. A copy of the agreement is included in Appendix.

The City currently has only one water sales contract, and that is with the Military Highway Water Supply Corporation (MHWSC). The MHWSC serves some of the subdivisions in the Southwest area. The MHWSC has a contract to purchase up to 4.0 MGD per month (147 acre-feet per year) from the City for service to the Southwest sub-area.

At present, the City is considering selling water to North Alamo Water Supply Corporation to serve few subdivisions on the Northwest portion of the City. However, no contract agreements were

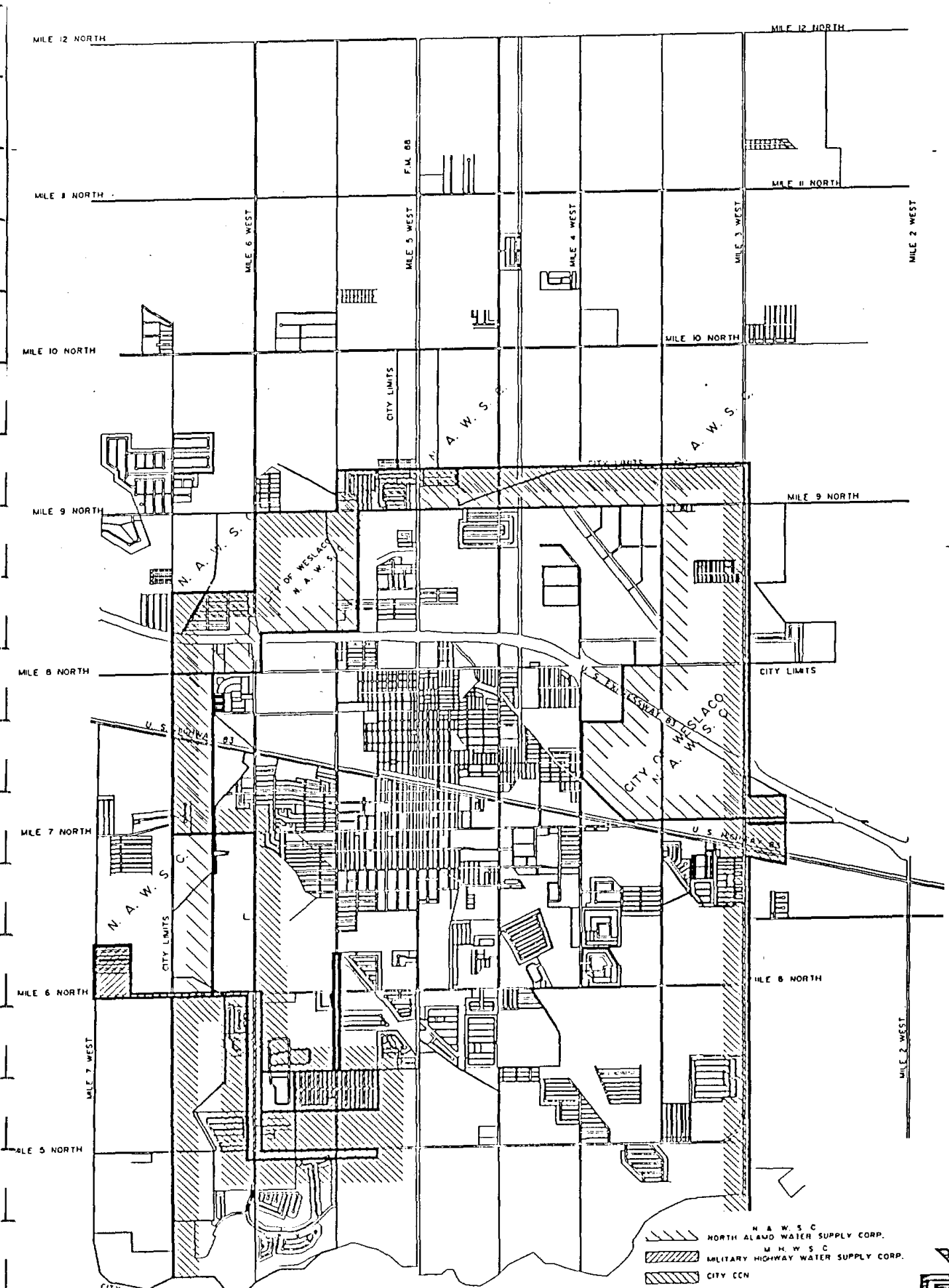

FIGURE 2.1

CITY OF WESLACO-WATER DISTRIBUTION SYSTEM
C C N MAP

NOTE:
CCN BOUNDARIES SHOWN ARE
APPROXIMATE ONLY

SIGLER,
PENNINGTON,
GREENE,
& ASSOCIATES, INC.
SIGLER
CONSULTING ENGINEERS
WESLACO-MYALLEN,
TEXAS
SINCE 1945

executed at this time.

3. Water Use

Table 2.1 summarizes the City's plant records for the period January 1990 through December 1995. The data indicate that the average daily municipal water use for the City was approximately 3.60 MGD or 48% of plant capacity. The average maximum day municipal water use for the same period was approximately 5.64 MGD or 75% of plant capacity. The ratio of maximum day to average day use was approximately 1.57. The maximum day for the data period occurred in August 1993 when 5.87 MGD of water was delivered to the City's water system. Based on the maximum day of record, the water plant was operating at approximately 78% of plant capacity.

Under a separate project, Weslaco EDAP Phase 1 Facility Plan, water billing records for the period January 1995 through December 1995 were studied, and it was found that the residential water demands accounted for approximately 73% of the total billed water use for the period. Commercial water use comprised approximately 12% of the total water demand with industrial use accounting for approximately 15% of the City's total water demand. Table 2.1 shows the system-wide average daily water demand for the data period to be approximately 3.6 MGD. Population data obtained from U.S. census data was used to determine the average per capita demand of the data period. The overall average daily water demand for the system (all use types) was, therefore, estimated to be approximately 148 gpcd. Assuming 85% of this use is attributable to residential demand, (including apartments and mobile homes that have commercial accounts) the average daily residential demand for the data period was estimated to be approximately 126 gpcd. Based on a maximum day demand of approximately 5.87 MGD, the overall maximum day demand is estimated to be approximately 239 gpcd, with residential demand amounting to an estimated 203 gpcd.

An unusual pattern was observed in the plant data. The per capita water consumption decreased from 1990 to 1995 (See Table 2.1). This decrease is assumed to have resulted from shut down of a few major industrial units, modification of process and recycling water in industrial and commercial establishments, public awareness of water conservation, and also due to increase in water rates during the data period.

A. Major Water Users:

As mentioned earlier, the City sells water to the Military Highway Water Supply Corporation (MHWSC) which serves a portion of the South and Southwest of the City. MHWSC has a master meter at the intersection of Mile 6 N and Mile 5 ½ W and draws water through a 12-inch City main located on Mile 5 ½ W. The City has a few other major industrial and commercial customers like Knapp Medical Center, McManus Produce, etc. Table 2.2 lists top 15 customers with their consumption history from 7/95 through 6/96. All these major customers were taken into account while evaluating the exiting water distribution system capabilities.

TABLE 2.1
Water Consumption Data
City of Weslaco

Month	1990			1991			1992			1993			1994			1995		
	Total	Max. Day	Min. Day	Total	Max. Day	Min. Day	Total	Max. Day	Min. Day	Total	Max. Day	Min. Day	Total	Max. Day	Min. Day	Total	Max. Day	Min. Day
Jan.	121.75	4.65	3.35	106.16	4.18	3.01	92.34	3.59	2.61	101.45	3.91	2.49	94.83	3.95	2.86	93.69	3.80	2.28
Feb.	104.55	4.75	3.00	102.13	4.34	3.09	90.85	3.77	2.69	101.20	4.47	2.79	85.93	4.09	2.92	102.29	4.48	2.34
Mar.	128.04	5.07	3.05	133.12	5.27	2.90	116.26	4.56	2.82	114.79	4.56	2.81	96.12	4.22	1.82	111.23	4.96	2.06
Apr.	117.62	4.76	3.02	111.83	4.77	2.68	96.07	3.96	2.55	125.55	4.93	3.02	121.01	5.09	2.48	109.91	5.30	2.73
May	129.99	5.32	2.75	115.11	4.64	2.74	87.05	3.54	2.00	114.78	4.49	3.14	119.70	5.41	2.48	129.33	4.94	2.56
Jun.	137.16	5.81	3.09	120.92	5.25	2.56	113.50	5.12	2.83	104.83	5.24	2.49	108.13	5.34	2.50	109.53	4.58	2.32
Jul.	132.65	5.50	2.95	115.14	5.52	2.83	131.19	5.30	2.83	136.68	5.55	3.07	141.55	5.59	3.13	133.33	5.60	2.92
Aug.	140.79	5.48	3.05	129.09	5.33	3.01	132.08	5.17	2.80	155.62	5.87	4.26	124.89	5.76	2.44	87.23	3.69	2.06
Sep.	111.22	4.64	2.89	84.86	3.68	1.93	63.82	5.21	2.83	110.59	5.13	2.83	88.78	3.86	2.31	86.74	3.70	1.95
Oct.	120.66	4.98	3.20	105.90	4.04	2.62	103.37	N/A	N/A	117.54	4.72	2.91	88.98	3.76	1.44	91.97	4.85	1.88
Nov.	113.23	4.36	3.08	93.19	3.64	2.58	90.32	3.59	2.60	100.49	3.96	2.70	100.99	3.85	2.43	74.74	3.42	1.86
Dec.	120.95	4.69	3.05	92.79	3.53	2.54	96.93	3.61	2.66	109.06	4.36	2.67	87.94	3.84	2.07	96.86	3.98	2.03
TOTAL	1478.61			1310.24			1213.78			1392.58			1258.85			1226.85		
Avg. Day Demand:	4.05 MGD			3.59 MGD			3.33 MGD			3.82 MGD			3.45 MGD			3.36 MGD		
Max. Day Demd.:	5.81 MGD			5.52 MGD			5.30 MGD			5.87 MGD			5.76 MGD			5.60 MGD		
Max. / Avg.	1.43			1.54			1.59			1.54			1.67			1.67		
Pop.*	22,739			22,672			23,500			24,404			25,533			28,105		
gpcd (all)	178			158			142			156			135			120		
gpcd (res)	151 gpcd			135 gpcd			120 gpcd			133 gpcd			115 gpcd			102 gpcd		
Avg. per capita demand from 6 yr. data (all uses)				148 gpcd														
Avg. per capita demand from 6 year data (res)				126 gpcd						Average per capita demand from year 1995 data:			102 gpcd					

* Historic Population from U.S. Census Data
 Population for 1995 interpolated from Wilbur Smith Associate's Projections

Table 2.2
Major Water Users

Consumer	07/95 (gals)	08/95 (gals)	09/95 (gals)	10/95 (gals)	11/95 (gals)	12/95 (gals)	1/96 (gals)	2/96 (gals)	3/96 (gals)	4/96 (gals)	5/96 (gals)	6/96 (gals)	# of Days	Avg. Day Use (gals)	Avg. Day Demand (gpm)
Military Hwy. Water Supply	5,399,600	4,281,800	4,000,600	3,926,200	3,174,500	2,852,400	3,881,300	3,665,000	4,352,100	4,837,100	4,918,400	5,369,300	366	138,411	96
Knapp Medical Center	1,104,200	814,000	739,700	6,022,900	3,129,500	2,988,300	2,825,400	2,877,200	3,397,900	1,477,900	2,573,800	1,675,100	366	80,945	56
Weslaco Labor Camp	223,900	184,100	2,140,000	1,774,000	2,039,000	1,996,000	2,352,000	2,683,000	2,656,000	3,241,000	4,494,000	1,465,000	366	68,984	48
Country Sunshine Park	1,207,300	1,024,500	918,900	1,077,600	1,116,600	1,026,800	1,691,500	1,701,800	1,883,600	1,560,100	1,242,700	1,119,200	366	42,543	30
John Knox Village	209,400	232,900	1,475,000	1,673,000	1,719,000	1,412,000	1,240,000	1,388,000	1,261,000	1,242,000	1,344,000	1,507,000	366	40,173	28
Weslaco Housing (N. Airport)	1,551,000	1,238,000	1,202,200	1,047,800	943,000	1,090,200	945,400	1,216,900	1,152,600	1,137,000	1,767,500	1,308,100	366	39,890	28
McManus Produce	593,400	953,300	720,700	1,151,100	1,501,900	1,412,400	1,421,400	1,984,700	1,782,600	303,700	1,306,300	283,300	366	36,652	25
High School	702,900	1,022,000	985,100	563,200	708,500	2,247,600	877,600	985,400	NA	953,100	1,116,900	729,300	335	32,512	23
Pine to Palm T P	79,900	30,100	559,000	397,000	1,325,000	1,417,000	1,936,000	1,987,000	1,756,000	797,000	644,000	755,000	366	31,921	22
Southern Comfort Resort Park	498,100	474,500	359,800	507,000	775,000	832,800	735,200	1,345,200	1,009,700	1,085,300	624,900	447,100	366	23,756	16
Casa De Amigos #5	189,000	74,000	0	960,000	920,000	950,000	1,090,000	1,590,000	1,640,000	183,000	190,000	160,000	336	23,649	16
Gulf Distributing	900	27,800	300	195,200	2,300	7,400	2,232,900	2,619,600	2,101,900	622,100	303,800	419,000	366	23,315	16
Palm Aire Motel	735,800	541,300	642,700	886,700	536,100	483,400	604,300	714,500	750,400	556,400	831,700	823,700	366	22,150	15
Ranchero Village Mob. Home Pk.	73,400	45,500	443,000	482,000	514,000	317,000	1,105,000	1,150,000	1,270,000	818,000	8,000	1,290,000	366	20,535	14
Adjutant General's Dept.	NA	NA	NA	NA	NA	NA	400,300	473,000	470,500	812,900	616,600	936,500	182	20,384	14

4. Population Projections

Successful long range water and wastewater planning is dependent on selection of appropriate population forecasting methods. For the purposes of this study, three previously published population studies were evaluated for appropriateness. These studies included:

- Population projections presented by Wilbur Smith Associates in the report entitled *Weslaco Tomorrow - City of Weslaco Comprehensive Plan* dated November 1990, based on US Department of Commerce, Bureau of Census projections;
- Texas Water Development Board Planning Division high series population projections developed for the 1992 Update of the Texas Water Plan, based on 1990 Census performed by the US Department of Commerce; and
- Texas Water Development Board Planning Division high series population projections developed for the TWDB's 1990 Texas Water Plan.
- Texas Water Development Board Planning Division - A 1996 Update to the Texas Water Plan. (In February 1997, the TWDB suggested that we use the updated population projections from the State Water Plan of 1996 in developing our final report.)

Each of the population forecasts are described briefly below.

Wilbur Smith Associates

In September 1990, Wilbur Smith Associates (WSA) of Houston, Texas, was contracted by the City to prepare the *Weslaco Tomorrow - City of Weslaco Comprehensive Plan*. The *Weslaco Tomorrow* study "...is a 20-year Comprehensive Plan that provides the goals, objectives, and policies needed to guide the growth within the City of Weslaco and its extraterritorial jurisdiction." As part of *Weslaco Tomorrow*, WSA conducted a comprehensive review of historical population growth and development trends in the Weslaco vicinity. The period of record evaluated by WSA began in 1930 when the City had a reported population of 4,879 persons. By 1960, when the In-City population was estimated to be 15,649 persons, the City had experienced an average annual growth rate of 3.96 percent. During the 1960s, the City experienced an overall population decrease of approximately 2.1 percent resulting in an annual growth rate of -0.22 percent. For the period 1970 to 1980, the City experienced a 2.36 percent average annual growth rate. The 1990 estimated population for the City of Weslaco used by WSA was 25,644 persons. The WSA population projections extend to 2010 and were developed based on the 1980 US Department of Census population estimates and the assumption that "...the City of Weslaco and Hidalgo County will continue to experience growth for the next 20 years at the same rate as the decade from 1970 to 1980."

Texas Water Development Board

The Texas Water Development Board (TWDB) is mandated under §16.051 and §16.055 of the Texas Water Code "...to prepare and maintain a comprehensive state water plan as a flexible guide for the orderly development and management of the State's water resources...." Population projections and associated municipal, industrial, and agricultural water use projections are developed as part of the TWDB's water planning process. Population projections developed by the TWDB are generally used

for all TWDB funded projects unless sufficient evidence can be produced which indicates alternative population forecasts should be used. The TWDB monitors population and migration trends throughout the state and adjusts their population projections accordingly between censuses. Due to the myriad of uncontrollable variables associated with population forecasting, the TWDB develops low and high series population estimates for major metropolitan areas. The TWDB reviews population estimates developed during the Census for correlation to their own estimates. Problems with the 1980 and 1990 Census have, however, caused the TWDB to be cautious of outright acceptance of the US Census as a benchmark for their population forecasts.

Through the 1980s, the TWDB developed population estimates which were based on revisions of the 1980 Census and ongoing tracking of population growth and migration trends throughout the state. The population projections developed in the 1990 Texas Water Plan (1990 Water Plan) reflected the TWDB's understanding of conditions in Texas during 1980s. When the 1990 Census was published, the TWDB expressed concern with the apparent statewide undercount of approximately 564,500 persons, based on a comparison to the estimates presented in the 1990 Texas Water Plan. Inclusion of these 564,500 persons to the official US Census statewide count yielded a 'statistically-adjusted' statewide population which was consistent with the TWDB high series population estimates for 1990, as presented in the 1990 Water Plan. As stated in the 1992 Update to the Texas Water Plan (1992 Update):

"Due to the uncertainty of the viability of the adopted 1990 Federal Census count, the existing state-federal litigation concerning these important figures, and the extremely close comparability of the Board's 1990 forecasts with the statistically-adjusted Census count, the Board feels comfortable using the 1990 Water Plan population forecasts for facility planning purposes until the next few years of annual Census estimates become available. At this later point, the likely settlement of the current state-federal litigation and the availability of additional annual Census populations should provide a better setting for a more clear assessment of any needed update changes."

In 1995, TWDB released "A 1996 Consensus-Based Update to the Texas Water Plan." The update was developed in conjunction with the Texas Natural Resources Conservation Commission and the Texas Parks and Wildlife Department and includes Weslaco's population and water use forecast through the year 2050. The 1996 Water Plan presents the population and water use projections based on different scenarios such as migration rates, conservation measures, and rainfall patterns. Based on these scenarios, a "Most Likely Series" was developed and presented in the update.

Table 2.3 summarizes the population projections presented by WSA and the TWDB. Population estimates for 1990 range from 21,877 persons (1992 Water Plan Update) to 26,950 persons (1990 Water Plan). The WSA estimate of In-City 1990 population was 25,644 persons. For the years 2000 and 2010, the WSA and 1992 Water Plan Update High Series figures are roughly equivalent. WSA's projection of 38,900 persons for the year 2010 is only slightly larger than the 1992 Water Plan Update High Series projection of 38,646 persons. The 1990 Water Plan forecast for 2010 is 48,009 persons, or approximately 10,000 persons greater than WSA and the 1992 Water Plan Update. By the year 2010, the 1990 Water Plan High Series projections forecast an In-City population of 48,009

persons (9,353 persons more than the 1992 Water Plan Update projections). For the same year, the Most Likely Series forecast is 36,241 persons (2,405 persons less than the 1992 Water Plan Update Projections).

For the purpose of this study, the most likely series population projections developed by TWDB for the 1996 Texas Water Plan will be used. (It is to be noted that, the high series population projections developed in October 1989 by the TWDB for the 1990 Texas Water Plan was used in the draft final report (submitted earlier) for determining projected water demand and wastewater generation for the City and surrounding areas. The final report is being adjusted based on the most likely series).

Using the TWDB Most Likely Series population estimates, the 1990 population for the City of Weslaco was estimated/found to be approximately 21,877 persons. The 2010 population for the City is projected to be approximately 36,241 persons. The growth rate for the decade 1990 to 2000 is projected to be approximately 3% per year and the growth rate for the decade 2000 to 2010 is projected to be approximately 2%. For the period 1990 to 2010, the City's population is projected to grow by approximately 66% (14,364 persons).

As reported in the WSA study, the City of Weslaco also experiences seasonal population growth resulting from the influx of "Winter Texans". Winter Texans, according to the WSA study, "... are seasonal residents who make their home in the Rio Grande Valley for up to five months per year." Based on estimates developed by the City of Weslaco, approximately 2,500 recreational and mobile home units are located inside the City Limits. The WSA study estimates that the In-City winter Texan population may amount to "...a 16% increase above the year round population." For the purposes of this study, it shall be assumed that the seasonal residents are included in the high series population projections.

It is clear from a review of the population forecasts presented above that a diversity of opinion exists with regard to projected population values. As stated previously, beginning in the year 2000, the 1992 Update to the Texas Water Plan and the Wilbur Smith Associates projections all are within 1,000 persons of each other. In contrast, the 1990 Texas Water Plan Low and High Series population estimates are consistently much higher than any of other projections presented. In order to reconcile this disparity in consensus regarding In-City population growth projections, the Engineers recommend using a 15-year planning period (1995 through 2010). Moreover, at this time, land use projections beyond year 2010 are not available and therefore, it is not feasible to estimate the growth pattern and suggest improvements beyond 2010. The year 2010 TWDB 1996 Water Plan Most Likely Series population projection for the City of Weslaco is 36,241 persons. Based on the 1995 In-City population estimate of 25,460 persons, a resultant 42% population growth would be anticipated over the planning period.

5. Water Use Projections

Table 2.4 shows TWDB municipal water use projections for the period 1990 through 2020. Assuming average per capita water use, the TWDB estimated the City's municipal water demand to

Table 2.3

Historical and Projected Population Growth for the
City of Weslaco

	Historical Population / Population Projections							
	1980	1985	1990	1995	2000	2005	2010	2015
Historical Population	19,331	23,837	-	-	-	-	-	-
TWDB 1990 Texas Water Plan Low Series Population Estimates			26,418	29,831	33,701	37,722	42,236	47,276
TWDB 1990 Texas Water Plan High Series Population Estimates			26,950	30,985	35,616	41,349	48,009	55,656
TWDB 1992 Update to 1990 Texas Water Plan Low Series Population Estimate			21,877	25,374	29,433	33,382	37,871	42,410
TWDB 1992 Update to 1990 Texas Water Plan High Series Population Estimate			21,877	25,460	29,623	33,827	38,646	43,917
TWDB 1996 Consensus-Based Update to the Tx. Water Plan - Most Likely Series			21,877		29,435	-	36,241	-
Weslaco Tomorrow (Wilbur Smith Associates, Nov. 1990)			25,644	28,105	30,800	34,610	38,900	-

Table 2.4

**Water Use Projections
City of Weslaco**

BASED ON TWDB ESTIMATE

Year	Population Series			Average Water Use (Acre-Ft/Yr)			Average Water Use (MGD)			Proj. Per Capita Cons. - Total (GPD)			Proj. Per Capita Cons. - Res. (GPD)			Projected No. of Connections		
	Low	High	ML	Low	High	ML	Low	High	ML	Low	High	ML	Low	High	ML	Low	High	ML
1990	26,418	26,950	21,877	4,472	4,572	3,255	3.99	4.08	2.91	151	151	133	128	129	113	na	na	na
2000	33,701	35,616	29,435	5,412	5,720	5,242	4.83	5.11	4.68	143	143	159	122	122	135	8,425	8,904	7,359
2010	42,236	48,009	36,241	6,416	7,294	6,455	5.73	6.51	5.76	136	136	159	115	115	135	10,559	12,002	9,060
2020	52,906	64,551	43,710	7,808	9,526	7,785	6.97	8.50	6.95	132	132	159	112	112	135	13,227	16,138	10,928

Notes:

Assumption: 4 persons per connection

ML - TWDB 1996 Update Texas Water Plan, Population Projection - Most Likely Series

be 159 gpcd in 2000, declining to approximately 140 gpcd in 2010, through steady implementation of water conservation practices. City billing records indicate that residential flows comprise approximately 85% of the existing municipal water demand (which includes only residential and commercial demands). Thus, assuming average per capita water use, the TWDB projections may be adjusted to remove the commercial demand component, yielding residential demand projections of 135 gpcd in 2000 and 119 gpcd in 2010.

For the purposes of this study, a system-wide average daily per capita design value of 150 gpcd will be used to estimate projected total water demand. This design value includes residential, commercial, and industrial demand requirements. Residential demand projections will be based on 120 gpcd.

Based on TWDB's Most Likely Series, Weslaco's water use (including all user categories) is projected to be approximately 4.41 MGD in 2000 increasing to 5.43 MGD by 2010. Should the population growth follow the TWDB's High Series Projections, then the water use will be 5.34 MGD in year 2000 increasing to 7.20 MGD by 2010.

6. Projected Water System Requirements

A. Water Rights:

Based on the Most Likely Projections, the City's current water allocation of approximately 6.42 MGD should serve the City beyond 2010. However, should the population growth follow High Series projections then the City's current water allocation could virtually be exhausted by the year 2005 when average daily In-City water demand is projected to be approximately 6.20 MGD. In order to meet the projected 2010 In-City average daily water demand projection of 7.20 MGD, the City would need to obtain an additional 0.78 MGD (approximately 875 AF/yr) of water rights. As mentioned earlier, the agreement between Irrigation District 9 and Weslaco will entitle the City to obtain additional rights as the City expands and annexes more and more land.

B. Water Treatment Plant:

The City's existing water treatment facility is rated at 7.50 MGD. Based on average daily In-City water demand projections, with TWDB's population estimates, the existing water treatment facility should have sufficient capacity to serve In-City residents beyond 2010 when demand is projected to be approximately 5.43 MGD. However, TNRCC regulations call out for a different evaluation criteria such as the plant capacity to be 0.6 gpm per connection. This is discussed in greater detail in the later portions of this chapter.

7. Existing Water Treatment Facilities

A. Raw Water Reservoir:

The raw water reservoir is located on the South side of the water treatment plant. The capacity of the reservoir is 162 acre-ft or approximately 53 million gallons. The raw water reservoir was constructed in 1988 for a cost of \$722,947.

A pump station is located on the North side of the reservoir and seats three Mixed Flow type pumps with a provision for future pump. Pumps 1 and 2 have a capacity of 2100 gpm and Pump 3 has 4200 gpm. These pumps convey raw water through a single 20-inch diameter pipeline into the Water Treatment Plant.

Also, there are three additional pumps at the canal with a total capacity of 8,400 gpm (two pumps of 2,100 gpm and one pump of 4,200 gpm).

B. Treatment Plant:

As mentioned earlier, the City operates and maintains a 7.50 MGD water treatment plant (WTP). The plant is located on Mile 9 North and FM 88 (Texas Blvd.) and consists of four treatment units. The plant provides treatment for turbidity reduction, taste, and odor. Three (3) raw water pumps deliver untreated water to a rapid mix chamber where liquid alum, lime, chlorine dioxide, and ammonia are added. From the rapid mix chamber, the water is diverted to three separate settling and filtration plants. Plant No. 1 provides sedimentation for the backwash water used in the plant. Plant No. 2, a 1.50 MGD facility providing facilities for flocculation, sedimentation, and filtration, was constructed in 1947. Records regarding the cost of its construction are not available. Plant No. 3, a 3.00 MGD flocculation, sedimentation, and filtration facility, was constructed in 1972 at a cost of \$702,011, and was sized to serve approximately 4,320 connections (approximately \$162.50/connection). Plant No. 4 is rated at 3.00 MGD and also provides facilities for flocculation, sedimentation, and filtration. Plant No. 4 was constructed in 1982 at a cost of \$1,000,768, and was intended to serve 4,978 connections (approximately \$201.04/connection). Plant Nos. 2, 3, and 4 ultimately discharge to the plant's clearwell facilities. Five (5) high service pumps supply treated water to the City's water distribution system. Figure 2.2 is an aerial photograph of the City's water treatment facilities. Figure 2.3 is a schematic of the water treatment plant process.

Chemicals presently used in the drinking water treatment process are as follows:

Polymer	added to the rapid mix basin to provide coagulation,
Lime	added to the rapid mix basin to adjust the pH of the water,
Chlorine dioxide	added to the rapid mix basins to reduce tastes and odors
Chlorine	added to the rapid mix basins to provide disinfection of the water,
Ammonia	added to the rapid mix basins to form chloramines to aid in disinfection of the water and limit formation of TTHM'S.

8. Water Distribution System

A. Clearwell & Storage:

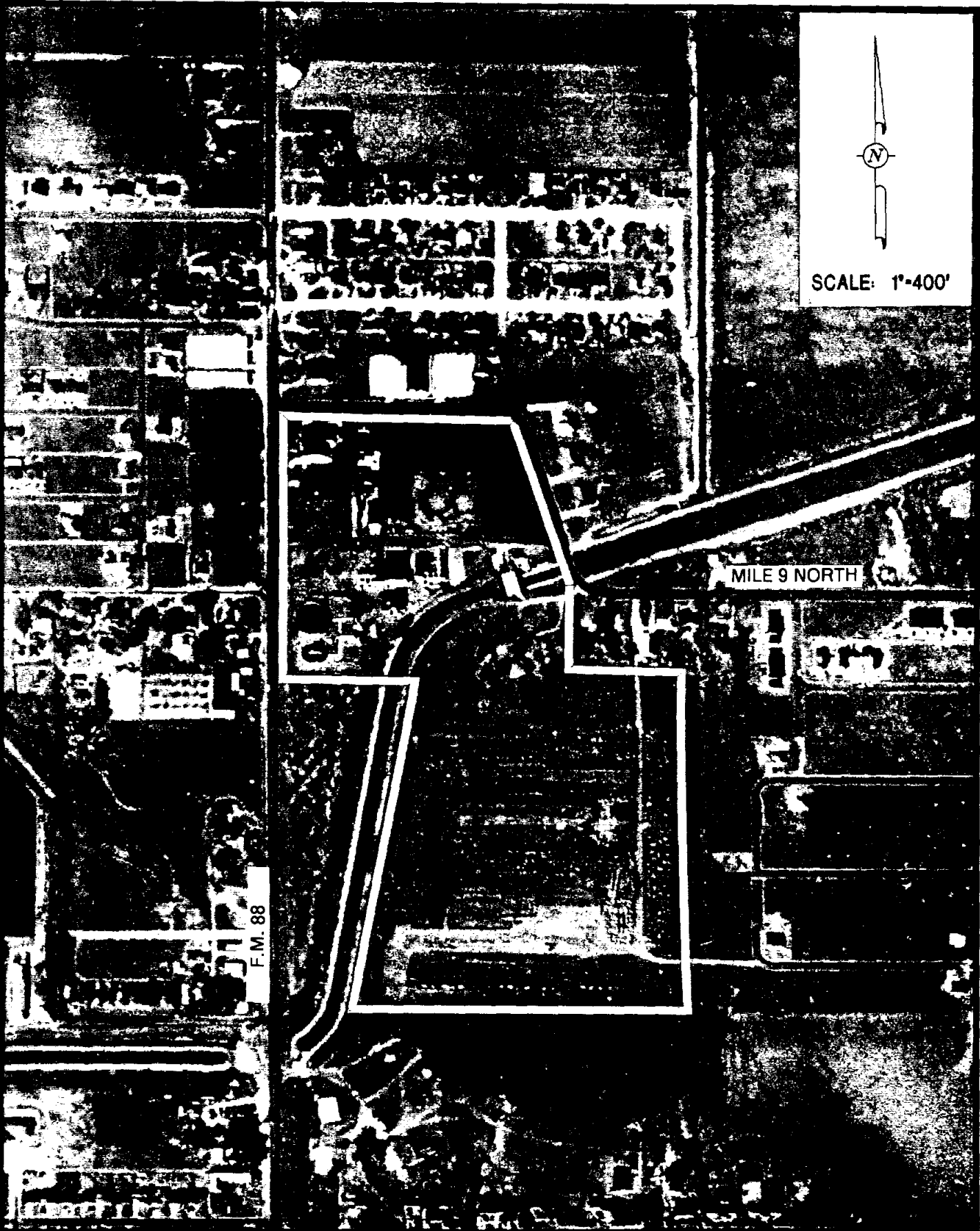
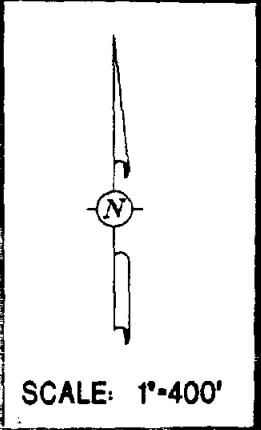

SIGLER, WINSTON GREENWOOD & ASSOC. INC.	CITY OF WESLACO REGIONAL WATER SUPPLY & WASTEWATER STUDY	FIGURE 2.2	Drawn By:
		Weslaco Water Treatment Plant and Surrounding Area	Date:

The city currently has two clearwells. Clearwell No. 1 is of 85,000 gallons capacity and is located on the Southeast of the plant. Clearwell No. 2 which is located on the North side of the plant has a capacity of 1 million gallons. Recently, the City awarded a contract to a local firm for the construction of a new 1.0 million gallon storage tank at the plant. The construction of the tank and installation of two high service pumps is expected to be completed by November 1997. With this additional tank, the City will have 2.08 million gallons of treated water storage capacity.

B. High Service Pumps:

At present, there are five high service pumps at the Water Treatment Plant. Pumps 1 and 2 are located at the Clearwell No. 1 and Pumps 3, 4, and 5 are located at Clearwell No. 2. As mentioned earlier, two more pumps will be installed at the new storage tank. Table 2.5 shows the capacity of all the present and future pumps. Performance curves of pumps 3, 4, & 5 are included in the appendix and curves for 1 and 2 are not available.

C. Distribution Lines:

Weslaco's water distribution system consists of water lines of sizes varying from 2-inches to 18-inches in diameter. In the past, the City replaced all old cast iron lines with asbestos cement lines. Therefore, it is assumed that, at present, the distribution system consists of asbestos cement lines and P.V.C. lines. Various sources were consulted to include all the major mains in the report.

Two 18-inch high service lines run west and east from a meter box located at the water plant. These lines are connected to the City's main distribution system. The City provides fire fighting capabilities with fire hydrants of varying sizes.

D. Elevated Storage Tanks:

The City has three elevated water tanks with a combined capacity of 1.3 MG. These elevated tanks are included in the system to help deliver peak demands and to provide fire flow storage. For the purpose of this study, these three tanks are designated as Tank 1, Tank 2, and Tank 3. Table 2.6 shows the details of the elevated tanks. Of the three, Tank No. 1 does not have an altitude valve. An altitude valve automatically shuts off the flow of water into a tank when it is full. This enables the operators to pump more distant elevated tanks which may not be full. Consultations with the City's Utilities Coordinator, Gilbert Aguillar, revealed that there are minor leaks in the Tank 1 and it needs to be repaired. Also, Mr. Aguillar mentioned that Tank # 2 fills before the other two are full.

9. Analyses of Existing System

The existing treatment plant and water distribution system were analyzed for both current demand and future demand. The following design criteria was used to do so.

A. Design Criteria - Treatment Plant & Storage:

Evaluation of the treatment plant and storage facilities were based on the TNRCC regulations found in Chapter 290 of Texas Administrative Code 30. The regulations call for evaluating the system based on the number of water connections, including commercial and industrial users, that are present

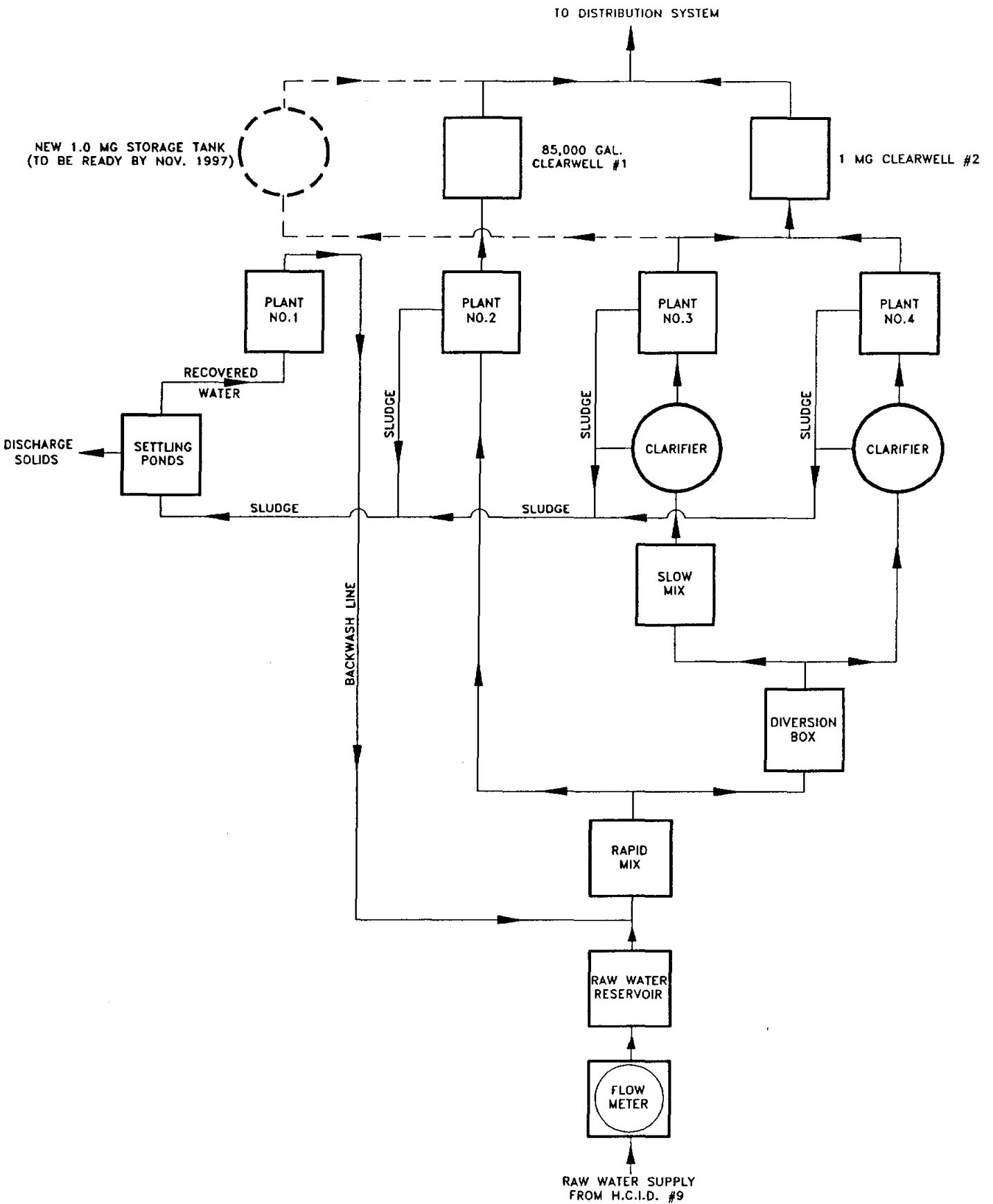

WATER TREATMENT PLANT
PROCESS FLOWCHART
CITY OF WESLACO, TEXAS

FIGURE 2.3

Table 2.5

High Service Pumps at the Water Treatment Plant
City of Weslaco

Pump No.	Manufacturer/Type	Capacity (gpm)	TDH (ft)	Location	Remarks
Pump 1	Aurora Pump	1,000	165	Clearwell No. 1	
Pump 2	Johnson Pump	2,000	165	Clearwell No. 1	
Pump 3	Fairbanks, Morse & Co.	2,100	165	Clearwell No. 2	
Pump 4	Fairbanks, Morse & Co.	2,800	165	Clearwell No. 2	
Pump 5	Fairbanks, Morse & Co.	3,500	165	Clearwell No. 2	
Pump 6	Horizontal Split Case	2,000	165	New Storage Tank	To be commissioned by Nov. 97
Pump 7	Horizontal Split Case	3,500	165	New Storage Tank	To be commissioned by Nov. 97

Notes:

Information provided by OMI

Pumps curves available for pumps 3, 4, & 5 only. (See appendix)

Total Capacity as of September 1996 : 11,400 gpm. With the largest pump out, the capacity is 7,900 gpm

Total Capacity by November 1997 : 16,900 gpm. With the largest pump out, the capacity is 13,400 gpm

TABLE 2.6

**Existing Elevated Water Tanks
City of Weslaco**

	Tank 1	Tank 2	Tank 3
Capacity	0.3 MG	0.5 MG	0.5 MG
Location	Second St. & Kansas	Bridge Ave. & 8th St.	M 6 1/2 W & Hwy. 83
Type	Multiple Leg	Multiple Leg	Multiple Leg
Head Range	39 feet	37 feet	37 feet
Top Elevation	220 feet	219 feet	219 feet
Overflow Elevation			
Year Last Coated		1995	1995
Year Constructed			
Manufacturer			
Altitude Valves	Not Present	Present	Present
Known Problems	Minor leaks		

Table 2.7

**Evaluation of Water System Capacities
City of Weslaco**

Item	Evaluation Criteria	Required	Provided	Excess/ Deficient()	Remarks
Raw Water Pumps	0.6 gpm/connection X 6,616 connections	3,970	12,600	8,630 gpm*	
Treatment Plant	0.6 gpm/connection X 6,616 connections	3,970	5,208	1,238 gpm	
Elevated Storage	100 gal/connection X 6,616 connections	661,600	1,300,000	638,400 gal	
Clear Well	5 % of Plant Cap. X 7.50 mgd	375,000	1,090,000	715,000 gal	
Total Storage	200 gal/connection X 6,616 connections	1,323,200	2,390,000	1,066,800 gal	
Service Pumps	2 gpm/connection X 6,616 connections	13,232	7,900	(5,332) gpm*	
Auxiliary Power**	0.35 gpm/connection X 6616 connections	2,316	2,000	(316) gpm	

Service Connections- City of Weslaco: 6,100
 Military Highway Water Supply Corporation 516
Total: 6,616 connections as of April 96

* With largest pump out.

** Auxiliary Power required to deliver a minimum of 0.35 gpm per connection to the distribution system

in the system.

Evaluation:

As of April 1996, the total number of connections in the system were 6,616. This figure was used to determine the system capacities and requirements. Table 2.7 shows the evaluation of the plant and storage.

As it can be seen from the table, the existing system has adequate treatment plant and storage capacity. This Table also shows that the system requires additional high service pumps and auxiliary power. As mentioned earlier, a new 1.0 MG storage tank with two high service pumps (2,000 and 3,500 gpm) are underway. By the end of November 1997, the total high service pump capacity will be about 13,400 gpm (with the largest pump out). With this addition, the system should come into compliance with the TNRCC regulations. A new auxiliary power unit is recommended and the cost estimate is shown in Chapter 3.

B. Design Criteria - Distribution System:

The criteria used in the evaluation of the present and future distribution system improvements are as follows:

1. The system will be designed to maintain a minimum of 45 psi throughout the system during the peak hour demand.
2. During fire flow conditions, a minimum of 20 psi will be maintained.
3. Maximum velocities in the distribution system should not exceed 5 fps.
4. The ratio of peak hour to average day demand is 2.0.
5. The mains should be placed out in such a way that a proper grid is formed and has at least two feeder lines to the major areas being served.
6. Fire flow Criteria:

The "Key Rate Schedule for Grading Cities and Towns of Texas" developed by the State Board of Insurance identifies minimum fire protection standards. It is used to calculate fire insurance rates for communities in Texas

Water mains must be at least 6 inches in diameter and looped in residential areas and a minimum of 8-inch diameter looped mains in mercantile areas. Fire hydrants must be connected to a 6-inch water main or larger with a minimum 5-inch valve opening. The hydrants must be properly spaced so that there will be a fire hydrant every 300 feet in mercantile and industrial areas and every 600 feet in residential areas, so that every building in the city limits will be within 500 feet of a hydrant.

The key rate schedule recommends the following minimum fire flows for cities and towns at 20 psi residual pressure:

Principle mercantile and industrial areas	3000 gpm
Light mercantile areas	1500 gpm
Congested residential areas	750 gpm
Scattered residential areas	500 gpm

Fire flow requirements and insurance rates are evaluated according to the risk to individual structures. This is determined from an evaluation of the size of the structure, the type of construction, exposure, whether or not a sprinkler system is installed in the structure, and other factors.

C. Water Network Model Development:

A computer model was used to evaluate the adequacy of the water distribution system under both present and future conditions and to assist in locating and sizing future lines. The KYPIPE model, developed at the University of Kentucky, was selected for use in evaluating the Weslaco facilities. The model used for this study is the Fortran version adapted to run on IBM PC-compatible computers. The model can run either a steady state condition or a continuous simulation representing the system operation over time.

Maps showing the size, location, and type of pipeline materials were consulted and coded into the format needed for computer input. Most pipelines in the system 6 inches and larger are entered into the system. Some of the smaller sized lines were also included to complete the loop. This is a good approach to reduce the size of the system and does not significantly affect the results. In addition, information on the elevated storage tanks and high service pump elevations was also coded into the program. A copy of the present system input used in the modeling is included in the Appendix. Also, a model diagram is included in this report.

Each pipe in the system was assigned a number. The end points of the pipe sections are called nodes and are classified as either Junction Nodes or Fixed Grade Nodes. Junction nodes are where two or more pipes meet, and where flow is added or removed from the system. Fixed grade nodes, in this case, are connections to storage tanks (elevated tanks and clear wells).

Estimated average demands at the nodes were coded into the input. Commercial demands were obtained from the meter data from 07/95 through 06/96. Residential demand was estimated by counting the number of lots surrounding a node and multiplying by 3.5 persons per lot and an average demand of 110 gallons per day per person. A table showing the average demand at each node is included in appendix.

D. Computer Model Calibration:

Computer model calibration is the process of adjusting data describing the mathematical model of the system until measured parameters, pressures and flow rates, are in reasonable agreement with modeled parameters over a wide range of operating conditions. Hydraulic calibration requires

modifying hydraulic properties until a sensible match between computer-generated and field-observed values are obtained. A good match is generally accepted as 0 to 5 psi.(+ or -).

The calibration effort for this study was intended to “fine tune” the pipe friction coefficients so that the computer-generated values in match the field-observed values at some fire hydrants. The fire hydrant tests performed by the Weslaco Fire Department were used to compare the computer generated results. Also, to the best possible extent, effort was made to simulate the high service pumping sequence at the plant and water levels at clearwells and all elevated storage tanks. Table 2.8 compares the results. As it can be seen from the table, the system pressures match the field observed results in all but a few locations. This can be attributed to the fact that the service area is reasonably flat, so minor variations in the system operating pressure influence flows and pressures to a much greater degree than in-system head losses.

E. Network Analyses - Current Conditions:

The pressure in the distribution system is currently maintained at a maximum of 60 to 65 psi. Water plant personnel mentioned that during average demand, high service pumps 1 and 3 or 1 and 4 are operated; and during a peak demand, pumps 1 and 5 are switched on. It was indicated to us that more than two pumps were rarely used. This pumpage produces a maximum pressure range mentioned above. Also, it is assumed that the pressure is maintained at this level in order to avoid/reduce number of line breaks in the system.

The model was run for both average and peak demands. It was found that, under average demand, the system pressure varied from 56 psi to 64 psi, with maximum pressure existing near the plant. This is obvious for the fact that the high service pumps are located in the plant, and the nodes in this vicinity will have high pressures. For average demand, pumps 1 and 3 were assumed to be operating and for peak demand, pumps 1 and 5 were assumed to be in operation.

Under peak demand, the system pressure varied from 50 psi to 64 psi. Figure 2.4 shows the existing system behavior for average and peak demands at the various nodes. Figure 2.5 shows the pressure contours of the existing water distribution system.

Fire Flows:

The existing distribution system was modeled for fire flow conditions at 14 locations. The required fire demand was assumed at each of 14 locations, and the model was run to determine the system behavior. The locations used for fire flow simulation are shown in Table 2.9

The results of fire flow simulations show that the system maintains at least 20 psi pressure, as recommended by State regulations, in the event of fire at all but two locations. In the event of fire at Llano Grande Home Sites, the system pressure varies from 18 to 64 psi and at Bellaire Subdivision, the system pressure varies from 13 to 64 psi. This is due to the fact that there are some smaller lines in the vicinity of these two areas that are causing a tremendous amount of head loss and therefore, low pressure in the system. Figure 2.6 shows the system wide pressure during fire flow simulations at these two locations. Improvements to the system are required to elevate the pressures above 20

WATER DISTRIBUTION SYSTEM PRESSURES EXISTING SYSTEM - CURRENT DEMAND

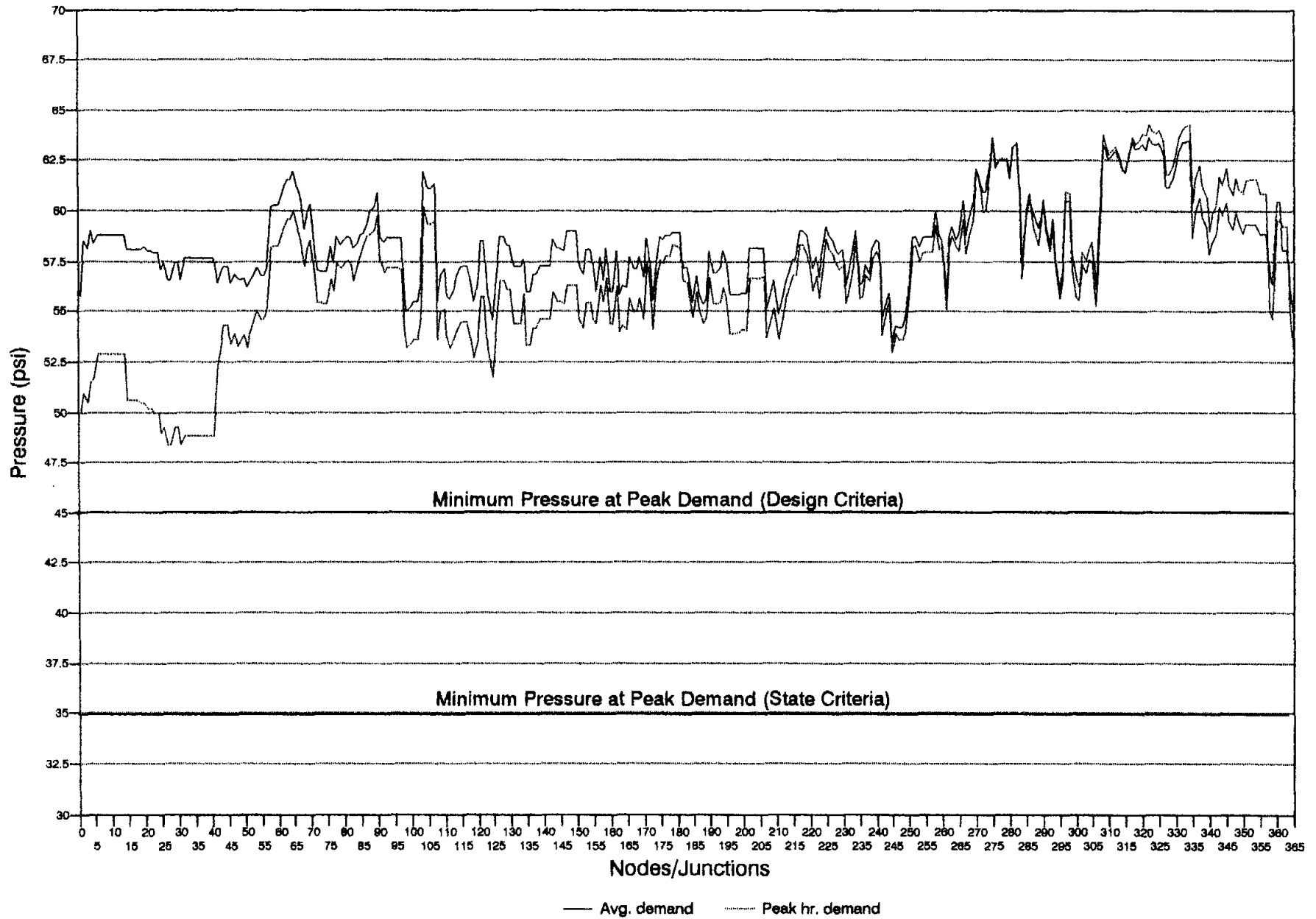

FIGURE 2.4

Table 2.9

**Locations of Fire Flow Simulation
City of Weslaco**

Location	Fire Flow Assumed	Junction/Node #	Remarks
K - Mart and Vicinity	3000 gpm	292	
McManus Produce	3000 gpm	175	
High School	1500 gpm	253	
Knapp Medical Center	3000 gpm	79	
John Knox Village	3000 gpm	166	
Llano Grande Home sites	750 gpm	3	
Texas Blvd. & Hwy. 83	3000 gpm	183	
Pine to Palm Trailer Park	750 gpm	71	
Bellaire Subdivision	750 gpm	147	
Snow to Sun Trailer Park	750 gpm	315	
Sam Houston Elementary School	1500 gpm	261	
Texas Blvd. & Plaza St.	750 gpm	234	
Airport	1500 gpm	309	
Mile 9 N and M 5 1/4 W	750 gpm	338	

Notes:

Fire Flow values obtained from "Key Rate Schedule for Grading Cities and Towns of Texas," developed by the State Board of Insurance.

For Junction/Node Numbers, please see the computer model diagram.

NODE PRESSURE W/ FIREFLOW SIMULATION AT LLANO GRANDE HOMESITES & BELLAIRE SUBD.

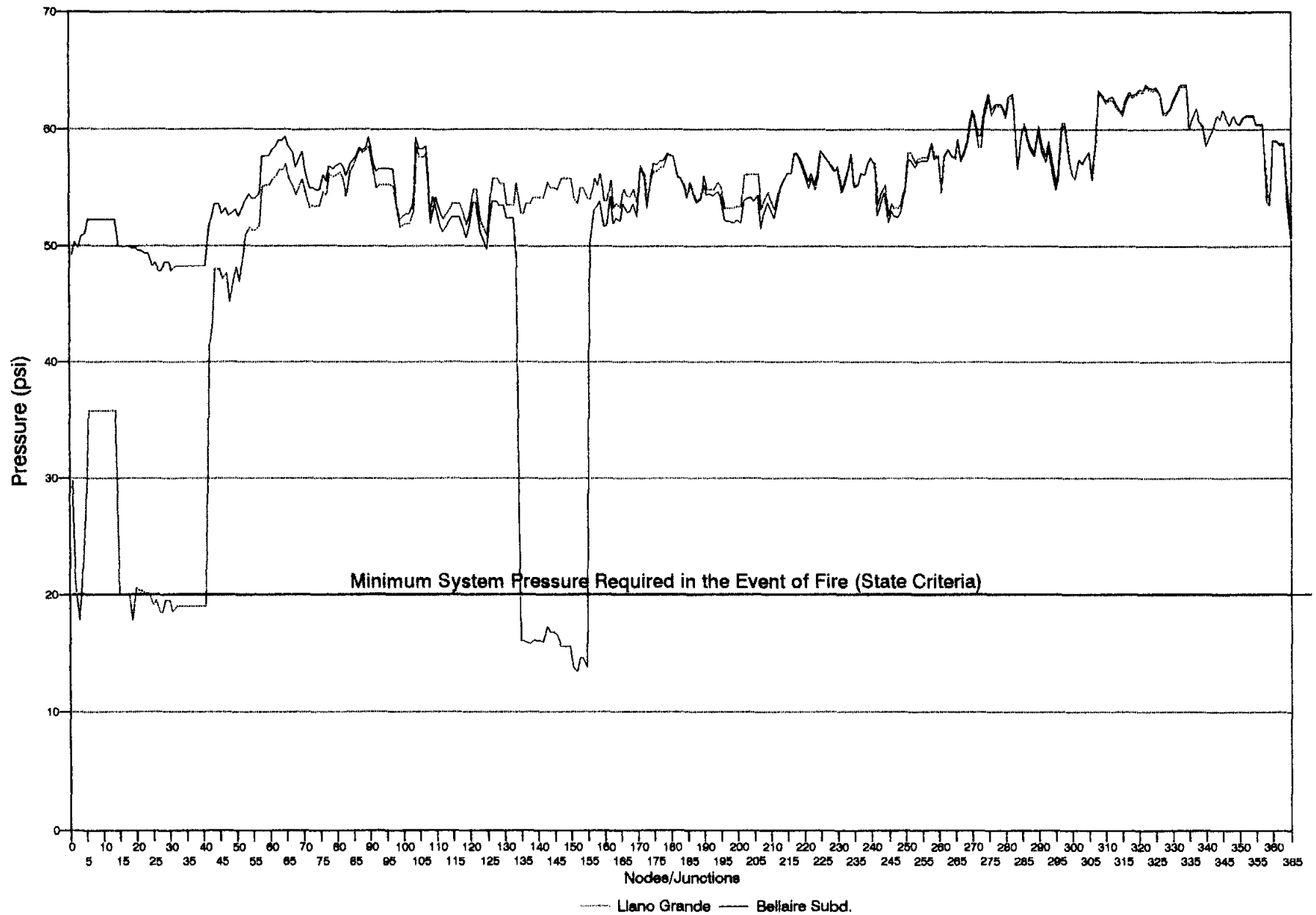

FIGURE 2.6

psi in the event of a fire at these two locations. The improvements needed are discussed in the following sections.

10. Network Analyses - Future Conditions

It is generally economically feasible to size water mains for demands anticipated 15 - 20 years in the future. The Weslaco water distribution system was modeled to determine the need for water transmission and distribution for the years 2000 and 2010.

As a first trial in determining year 2010 water system improvements, the demand in the new growth areas were placed at the end of the existing water lines closest to the areas to be served. The model was run to determine the capability of serving future demands through existing lines and to determine new lines within the existing system. Once the new lines within the existing service areas were sized and located, the basic grid of an expanded system to serve water to the growth areas was developed and alternative sizes and locations determined.

Although population projections are available for the whole City, for years 2010, there is no information that showed the exact locations where the population would increase. Therefore, in order to simplify the system, based on the best engineering judgement, certain assumptions in determining population growth per acre were made. A conservative figure of 3.5 lots per acre and 3.5 persons per lot (equivalent to 14 persons per acre) was used to project the demand at the nodes that fall in the growth areas. Land zone projections from Weslaco Tomorrow were followed to determine the demand type, i.e., residential, commercial, agricultural etc. In order to simplify the system, as mentioned above, a system wide per capita average demand of 150 gallons per day was used. This figure includes all types of water use. This gives an approximate estimate of 1.46 gpm of average demand per acre.

For the year 2000, the same procedure mentioned above was followed. It was assumed that by the year 2000, most of the vacant land within the current City limits will be developed into residential or commercial areas. Again, Weslaco Tomorrow study was followed for determining the type of land use for the year 2000.

After lines to serve both existing and future demand were determined, the system was tested to see if fire flow requirements could be met. This analysis resulted in modifications to the system to ensure that fire flow demands can be met throughout the area to be served. The final recommended plan is capable of meeting peak hourly demands and with fire demands superimposed on the peak hour demand.

The new areas served by the water distribution system additions that are proposed for year 2010 are largely areas that are presently undeveloped. Also, it should be noted that the lines are proposed within the City's present CCN limits. The proposed system comprises primarily of 12-inch water mains with 8-inch forming a grid to deliver water within the subareas. As demands increase, or if the City's CCN is expanded (either by buy out of NAWSC's lines or entering into a inter local

agreements), additional 12-inch and 8-inch lines will be needed to deliver water to specific developments and customers. The exact location of these lines will depend on the development patterns. The computer model can be used to size and locate these lines. In most cases, lines serving commercial and industrial areas should be 8-inches and larger, while 6-inch looped lines may be adequate in some residential areas.

A. Performance of proposed system for future conditions (yr 2000, from modeling)

After analyzing the existing system and suggesting improvements, the proposed system was checked for the estimated demand for the year 2000. It was found that the system pressure drops below 20 psi at some locations in the event of fire in the Southwest portion of the City. To elevate the system pressure, an elevated water tank is added to the system in the Southwest and general vicinity. The proposed system with additional tank provides fire fighting capabilities and also enhances the system pressure above 20 psi.

B. Performance of proposed system for future conditions (yr 2010, from modeling)

Similarly, the demands estimated for the year 2010 was coded into the proposed system and the model was run to study the behavior with and without fire flows. It was found though there is an increase in demand at certain nodes, the overall system pressure did not change/decrease significantly. Therefore, no additional water tanks (other than the proposed for year 2000) are necessary. However, should the growth pattern be different from the one shown in Wilbur Smith and Associates's study, a need for a new tanks should be determined after updating the model accordingly. Figure 2.7 shows the junction pressures in the year 2000 and 2010.

11. Recommendations

A. Distribution Mains:

Following the design criteria discussed earlier, it is necessary to add some lines of sizes varying from 6 inches to 12 inches in diameter. These lines not only help in providing the required fire flows and peak demands, but also form a better grid for water supply. Figure 2.8 shows the existing and proposed improvements. The required lines along with the cost estimates are shown in the next chapter. A detailed full scale map is provided in this report that shows existing and proposed water mains. (See Appendix).

Again, most of the dead end lines were proposed to be looped with a line of at least the same size. The lines proposed on the North side of the City extend up to the existing CCN only (Mile 9 ½ N). It is unclear, at this time, whether it is possible for the City to expand its water CCN by purchasing some areas from North Alamo Water Supply Corporation. In the future, if the City is able to acquire some areas from NAWSC, it is recommended that the lines are placed in such a way that a proper loop is formed. Also, it is very important for the City to encourage the new developers to extend a minimum 6-inch line for residential and a minimum 8-inch line for commercial purposes.

B. Water Treatment Plant Improvements:

Based on the TWDB's high series populations estimates and engineer's estimated demand of 150

FUTURE WATER DISTRIBUTION SYSTEM JUNCTION PRESSURES AT PEAK DEMAND

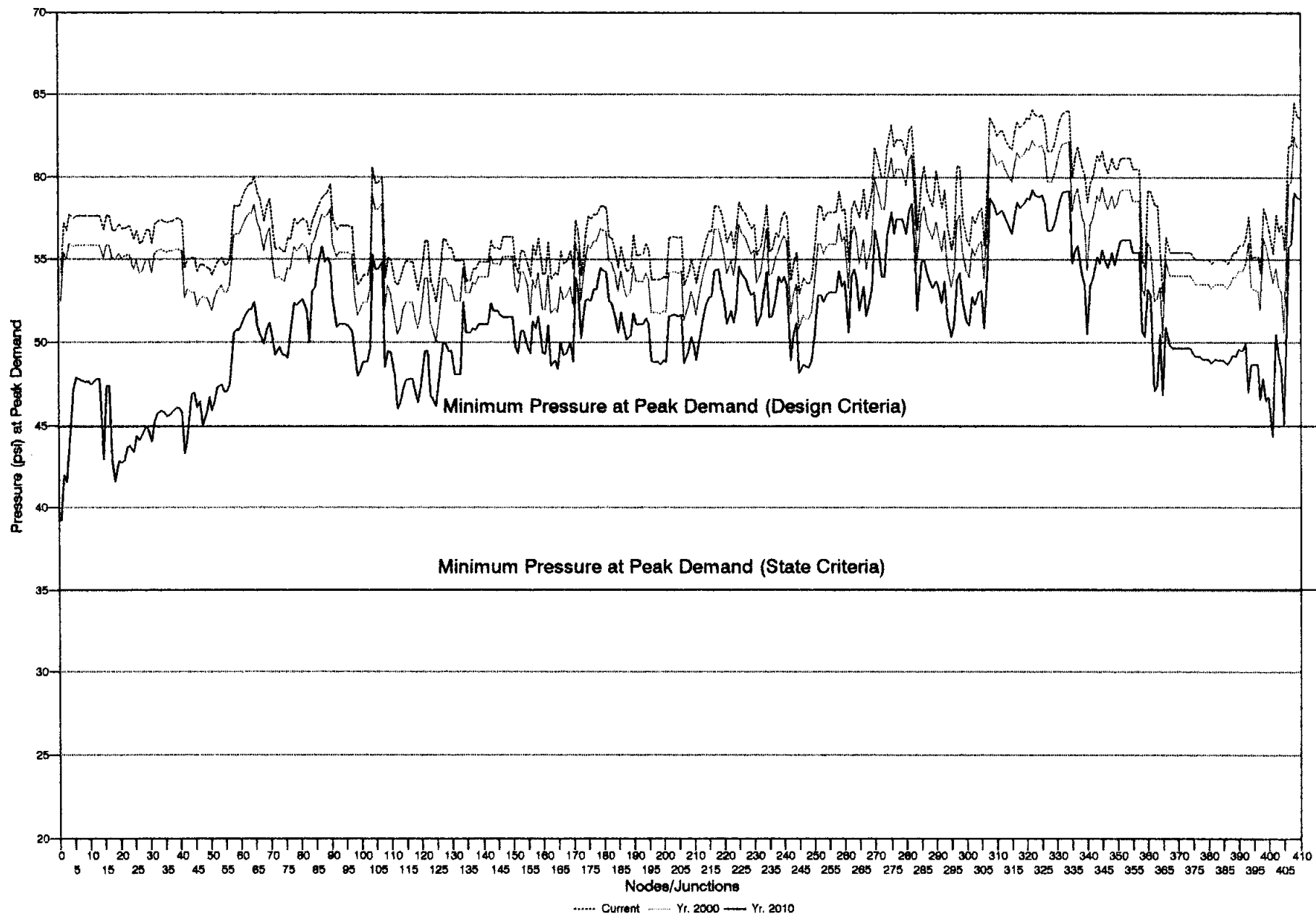

FIGURE 2.7

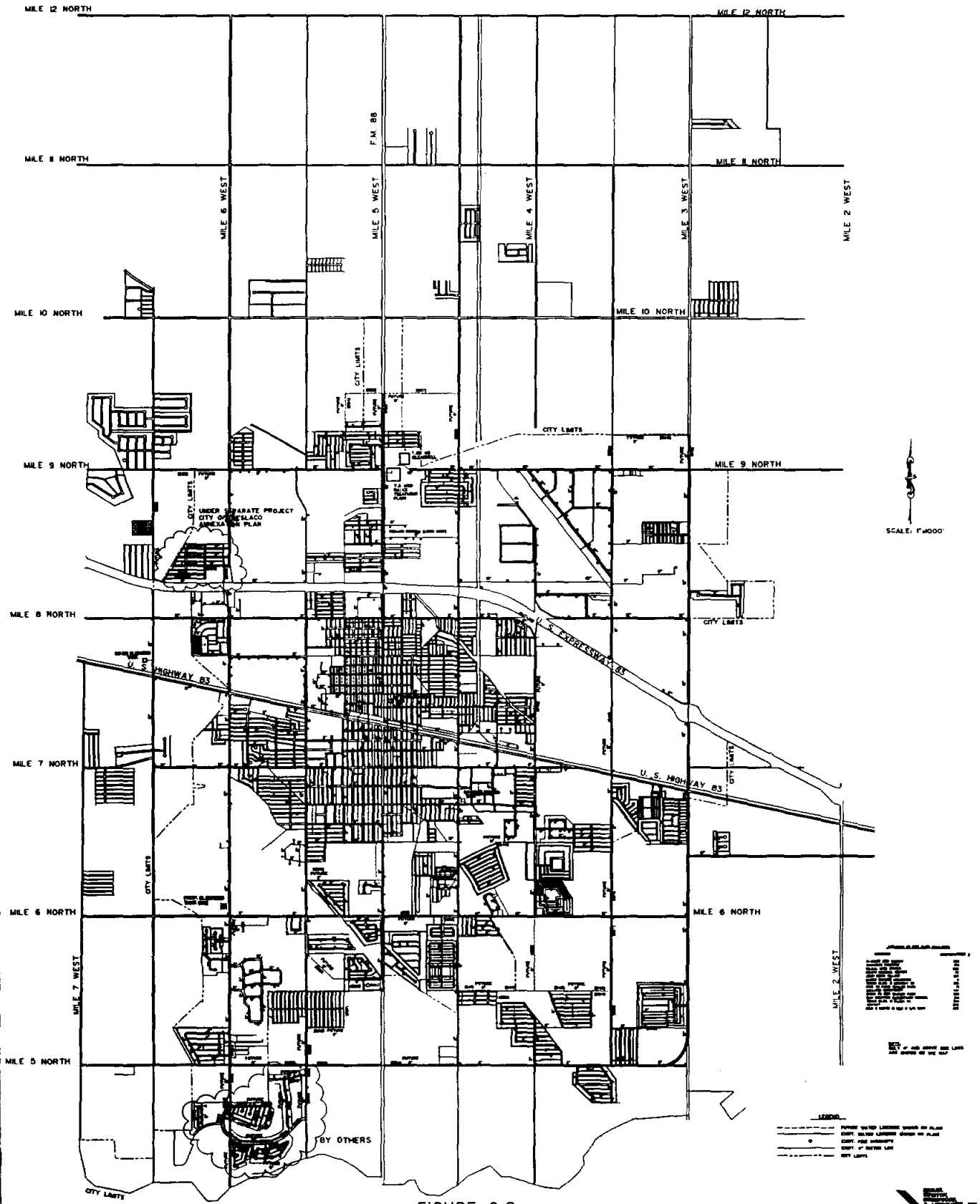

FIGURE 2.8
 CITY OF WESLACO-WATER DISTRIBUTION SYSTEM
 EXISTING SYSTEM AND PROPOSED IMPROVEMENTS

LARGER MAP IS INCLUDED IN APPENDIX



Handwritten note: Section 2.8.1

gallons per capita per day, the existing water treatment plant is sufficient to handle demand up to year 2010. However, TNRCC criteria requires that the water treatment plant be based on the number of estimated connections for the design period. As it can be seen from the Figure 2.9, based on TNRCC criteria, a new treatment plant would be necessary in the year 2001 (considering most likely Series). Historical information of the plant pumpage and city wide demand suggests that the TNRCC's criteria is slightly over exaggerated. By analyzing the figure further, and by using the best engineering judgment, it is estimated that the City may need an additional 3.0 MGD plant in the year 2005. However, it is suggested, that the City observe the growth pattern, and some where around the year 2000, conduct a study to analyze the need for another plant. A cost estimate for the 3.0 MGD plant is provided in the next chapter in case the study shows that a new plant is necessary. Site reconnaissance revealed that the existing water plant site can accommodate a new 3.0 MGD plant, and therefore, an alternate site may not be required.

C. Storage Requirements

With the addition of a new storage tank at the plant, the total storage capacity will be 3.39 MG. This includes the clearwells and elevated storage tanks. With an estimate of 12,000 connections in the year 2010, and using TNRCC's criteria of 200 gals/connection, the City should have about 1.0 MG of reserve storage capacity in the system.

Based on 100 gals/connection of elevated storage requirement for the year 2010, about 1.2 MG of elevated storage capacity is needed. The current tanks have a combined capacity of 1.3 MG. It should be noted that Tank # 1, (0.3 MG capacity) was built more than 50 years ago and therefore may not be fully dependable. If a major breakdown of this tank occurs, then the system will have inadequate storage tank capacity. Therefore, it is recommended that, to have sufficient reserve capacity and to provide required fire flows, a new elevated water tank of 0.5 MG capacity be constructed. Preliminary calculations and model runs for the year 2000 found that a suitable location for the new tank would be at the intersection of M 6 N and M 6 W or in the general vicinity. However, the exact location of the tank should be determined by observing the growth pattern and by updating the computer model.

D. Miscellaneous:

In order to avoid complications, it is advisable to have identical CCNs for both water and wastewater systems for the City of Weslaco. This facilitates the City in annexing land with greater ease and provides both the services to its new citizens. Also, NAWSC does not provide any fire protection with their lines, so when the City annexes new areas, fire protection could be provided at greater ease. Therefore, it is suggested that the City negotiate with NAWSC to implement a phased buy out of the service areas from NAWSC. It is also recommended that the City purchase some of the areas from the Military Highway Water Supply Corporation for the same reasons discussed above.

State regulations call for a minimum of 9 feet separation distance between a sewer and a water line. It is very important to follow these guidelines for all the new lines that are proposed. Guidelines for sewer/water line separation can be found in Chapter 317 of Texas Administrative Code 30. Also, all the future lines should be of AWWA C-900.

PROJECTED TREATMENT PLANT CAPACITY CITY OF WESLACO

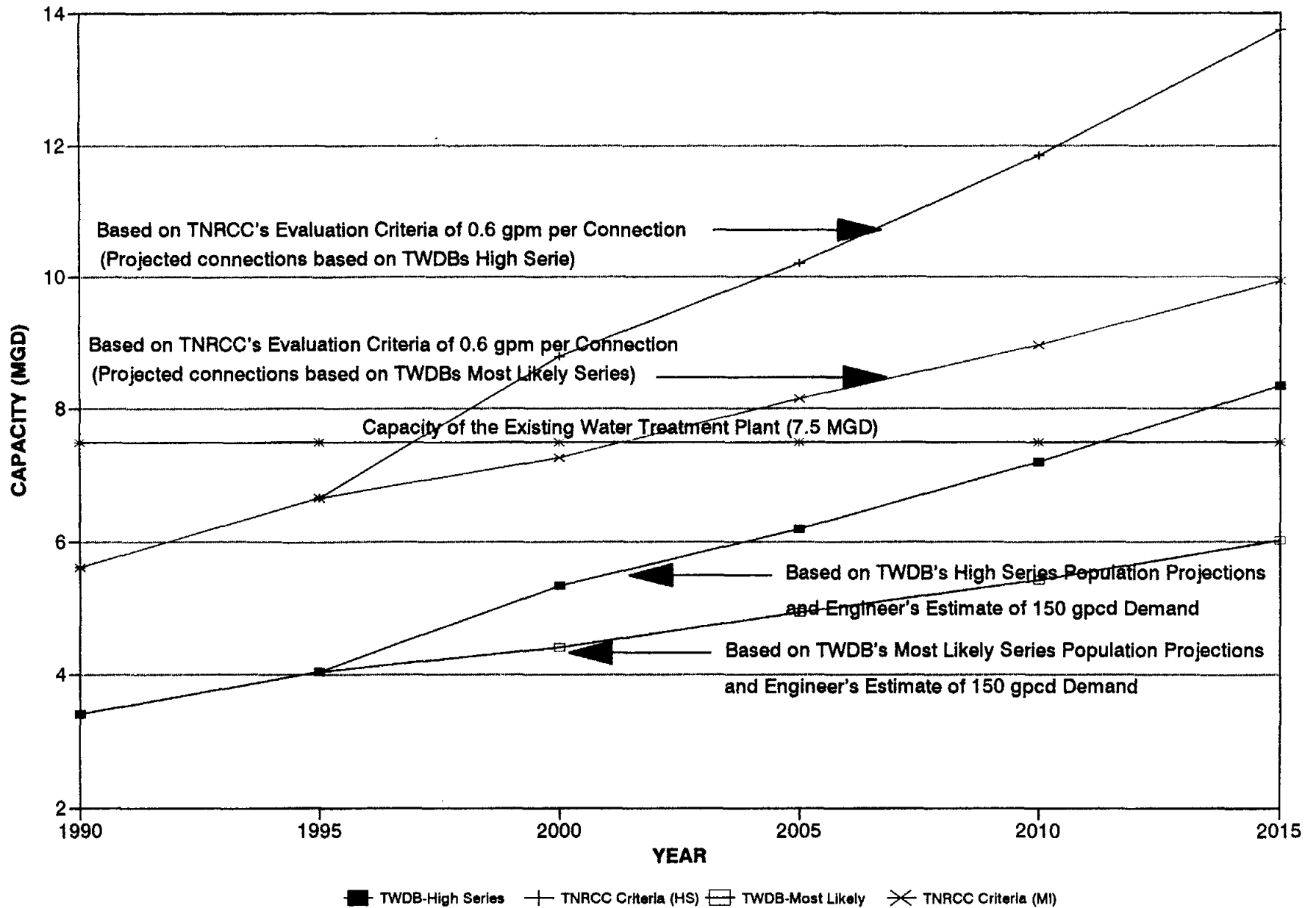

HS - High Series; ML - Most Likely Series

FIGURE 2.9

The City has recently adopted a Water Conservation and Emergency Water Demand and Management Plan. It is suggested that the citizens be educated with this plan, so that water supply problems can be minimized under severe drought conditions. A copy of the plan is included in the appendix. At this stage of the study, it is learned that the City is in the process of updating the plan. If available, the amended plan, will be included in the final report.

Finally, it is suggested that the model be updated at the end of each year by including new lines and demands from the new subdivisions/commercial establishments. This will keep the City informed about the distribution system behavior from time to time. In case of a major emergency such as a tank or a main break down, the behavior of the system needs to be checked, and necessary actions be taken accordingly. Also, when adding a new industrial or commercial customer that requires high demand, the system behavior is to be checked, and the pipe sizes required for such a development need to be designed by using the computer model.

Updating the model and checking the system behavior from time to time can be done by the City either in-house or by hiring a consultant engineer. In case the City decides to perform system check in house, a computer with necessary peripherals and KYPIPE software are required. A preliminary cost estimate for purchasing such equipment is included in chapter 3.

CHAPTER 3

COST ESTIMATION OF THE IMPROVEMENTS

1. Preliminary Cost Estimate

An Engineer's opinion of probable construction cost is provided for all the improvements discussed in the study. The cost estimate is based on manufacturer's budget prices and discussions with local contractors. Also, bid tabulations of prior wastewater projects of Weslaco were used to determine the costs. The overall cost summary for wastewater system improvements is given in Table 3.1.

The costs shown in the report are based on the current (1996) prices. It is suggested that the cost of improvements be adjusted based on the actual year of implementation/construction and by considering the annual inflation rate. It should be noted that these estimates are not final and subject to revision at the time of final design phase.

For the purpose of the study, the City wide improvements are divided as:

Southwest Quadrant Improvements - South of 6th St. (Mile 7 N) and West of Texas Blvd.
(Mile 5 W)

Southeast Quadrant Improvements - South of 6th St. & East of Texas Blvd.

Northwest Quadrant Improvements - North of 6th St. and West of Texas Blvd.

Northeast Quadrant Improvements - North of 6th St. and East of Texas Blvd.

Table 3.1

COST SUMMARY OF PROPOSED IMPROVEMENTS

Item	Cost	Remarks
Southwest Improvements	\$353,200.00	
Southeast Improvements	\$387,000.00	
Northwest Improvements	\$499,200.00	
Northeast Improvements	\$338,000.00	
Altitude Valve at Elevated Tank # 1	\$20,000.00	
Patchwork on Elevated Tank # 1	\$75,000.00	
Auxiliary Power Unit at the Plant	\$25,000.00	
New Elevated Storage Tank (0.5 MG)	\$500,000.00	
Engineering Study for New Plant	\$75,000.00	
Water Treatment Plant Addition	\$3,000,000.00	If found necessary
Computer System & Software	\$5,000.00	
Subtotal	\$5,277,400.00	
Contingency (15%)*	\$791,610.00	
Engineering (7%)	\$369,418.00	
TOTAL	\$6,438,428.00	

* 15% contingency to cover miscellaneous connections, unidentified utilities relocation, possible additional bores, precautions, traffic control and other conditions not anticipated at this preliminary report level.

Table 3.2

**WATER DISTRIBUTION SYSTEM
PROPOSED IMPROVEMENTS**

Southwest Quadrant

Item	Item Description	Quantity	Units	Unit Cost (\$)	Item Cost (\$)	Remarks/ Line # (See Computer Model Diagram)
1	12-inch P.V.C. on M 6 W (between M 6 N & M 3/4 N)	900	L.F.	20.00	18,000.00	Line # 489
2	12-inch P.V.C. on M 6 W (E of Bellaire Subd. to M 5 N)	1200	L.F.	20.00	24,000.00	Line # 490
3	12-inch P.V.C. on M 6 W (Extend to Tierra Santa)	1850	L.F.	20.00	37,000.00	Line # 491 & 492
4	8-inch P.V.C. on M 5 N (from M 6 W to M 5 1/2 W)	2600	L.F.	16.00	41,600.00	Line # 522
5	8-inch P.V.C. on M 5 N (from M 5 1/2 W to M 5 W)	2600	L.F.	16.00	41,600.00	Line # 523
6	8-inch P.V.C. on M 5 1/2 W (from M 5 N to M 5 1/4 N)	1400	L.F.	16.00	22,400.00	Line # 525
7	8-inch P.V.C. on M 5 1/4 N (from M 5 1/2 W to M 5 1/4 W)	1300	L.F.	16.00	20,800.00	Line # 526
8	8-inch P.V.C. on M 5 1/4 W (from M 5 1/4 N to M 5 1/2 N)	1300	L.F.	16.00	20,800.00	Line # 527
9	8-inch P.V.C. on Wimbledon Dr. W (Hidden valley)	650	L.F.	16.00	10,400.00	Line # 528
10	8-inch P.V.C. along Drainage R.O.W. (S of Quail Hollow)	1700	L.F.	16.00	27,200.00	Line # 529
11	8-inch P.V.C. along M 6 1/4 N (from M 6 W & M 5 1/2 W)	2300	L.F.	16.00	36,800.00	Line # 564
12	6-inch P.V.C. on NW of Southland Hts. to M 5 1/2 W	900	L.F.	14.00	12,600.00	Line # 530
13	Suspended Ditch Crossing (Line # 564)	1	LS	10,000.00	10,000.00	
14	Elevated Canal Crossing (Line # 564)	1	LS	20,000.00	20,000.00	
15	Suspended Ditch Crossing (Line # 523)	1	LS	10,000.00	10,000.00	
TOTAL FOR SOUTHWEST IMPROVEMENTS					\$353,200.00	

Southeast Quadrant

Item	Item Description	Quantity	Units	Unit Cost (\$)	Item Cost (\$)	Remarks/ Line # (See Computer Model Diagram)
1	8-inch P.V.C. on M 5 N (from M 5 W to M 4 1/2 W)	2600	L.F.	16.00	41,600.00	Line # 524
2	8-inch P.V.C. on M 6 N (from M 5 W upto W. Loop 19th)	2350	L.F.	16.00	37,600.00	Line # 531 & 532
3	6-inch P.V.C. on M 4 1/4 W (from M 5 1/2 N to 29th St.)	500	L.F.	14.00	7,000.00	Line # 533
4	6-inch P.V.C. on Erasmo Dr. to M 5 1/2 N	200	L.F.	14.00	2,800.00	Line # 534
5	8-inch P.V.C. from SW of Siesta Vg. to NE of Los Castillo	450	L.F.	16.00	7,200.00	Line # 535
6	8-inch P.V.C. on M 3 1/2 W (from M 5 1/2 N to M 5 1/4 N)	1600	L.F.	16.00	25,600.00	Line # 536
7	8-inch P.V.C. on M 3 1/2 W (from M 6 N to M 5 1/2 N)	2600	L.F.	16.00	41,600.00	Line # 537
8	8-inch P.V.C. on M 3 1/2 W (from M 6 N to 11th Street)	2800	L.F.	16.00	44,800.00	Line # 538
9	8-inch P.V.C. on M 4 W (from M 6 N to M 5 1/2 N)	2600	L.F.	16.00	41,600.00	Line # 539
10	8-inch P.V.C. on M 5 1/2 N (from M 4 W to M 4 1/4 W)	1300	L.F.	16.00	20,800.00	Line # 540
11	8-inch P.V.C. on M 5 1/2 N (from M 4 1/2 W to M 4 1/4 W)	1300	L.F.	16.00	20,800.00	Line # 541
12	8-inch P.V.C. on M 5 1/2 W (from M 3 1/2 W to M 4 W)	2600	L.F.	16.00	41,600.00	Line # 542 & 543
13	6-inch P.V.C. from SW of RoEllen to 13th St.	1000	L.F.	14.00	14,000.00	Line # 544
14	Suspended Ditch Crossing (Line # 524)	1	LS	10,000.00	10,000.00	
15	Suspended Ditch Crossing (Line # 539)	1	LS	10,000.00	10,000.00	
16	Suspended Ditch Crossing (Line # 542)	1	LS	10,000.00	10,000.00	
17	Suspended Ditch Crossing (Line # 544)	1	LS	10,000.00	10,000.00	
TOTAL FOR SOUTHEAST IMPROVEMENTS					\$387,000.00	

Table 3.2 (Continued)

**WATER DISTRIBUTION SYSTEM
PROPOSED IMPROVEMENTS**

Northwest Quadrant

Item	Item Description	Quantity	Units	Unit Cost (\$)	Item Cost (\$)	Remarks/ Line # (See Computer Model Diagram)
1	6-inch P.V.C. on Pena Avenue	800	L.F.	14.00	11,200.00	Line # 548
2	8-inch P.V.C. from Expressway to Corpus Christi Dr.	600	L.F.	16.00	9,600.00	Line # 549
3	8-inch P.V.C. on Corpus Christi Dr. to Anaqua St.	650	L.F.	16.00	10,400.00	Line # 550
4	8-inch P.V.C. from Anaqua St. to M 6 1/2 W	2200	L.F.	16.00	35,200.00	Line # 551
5	8-inch P.V.C. on M 6 1/2 W (from Expressway to M 9 N)	3800	L.F.	16.00	60,800.00	Line # 552
6	8-inch P.V.C. on M 9 N (from M 6 W to M 6 1/2 W)	2600	L.F.	16.00	41,600.00	Line # 553
7	8-inch P.V.C. on M 5 1/4 W (from M 9 1/4 N to M 9 1/2 N)	1500	L.F.	16.00	24,000.00	Line # 554
8	8-inch P.V.C. on M 9 1/2 N (from M 5 W to M 5 1/4 W)	1350	L.F.	16.00	21,600.00	Line # 555
9	12-inch P.V.C. on M 5 W (from M 9 1/4 N to M 9 1/2 N)	1500	L.F.	20.00	30,000.00	Line # 556
10	8-inch P.V.C. on M 6W from Cleckler Sch. to C Christi Dr.	2800	L.F.	16.00	44,800.00	Line # 562
11	Elevated Canal Crossing (Line # 551)	1	LS	20,000.00	20,000.00	
12	Elevated Canal Crossing (Line # 553)	1	LS	20,000.00	20,000.00	
13	Water Line Improvements for Expressway Heights	1	LS	170,000.00	170,000.00	Under Separate Project (Annexation Plan, Yr. 1995)
TOTAL FOR NORTHWEST IMPROVEMENTS					\$499,200.00	

Northeast Quadrant

Item	Item Description	Quantity	Units	Unit Cost	Item Cost	Remarks/ Line # (See Computer Model Diagram)
1	8-inch P.V.C. on M 3 1/2 W (from Expy. to Hwy. 83)	4000	L.F.	16.00	64,000.00	Line # 545
2	8-inch P.V.C. on M 4 W (from M 7 3/4 N to Clifton St.)	2100	L.F.	16.00	33,600.00	Line # 546
3	8-inch P.V.C. loop from M 4 W to Pike Blvd.	1500	L.F.	16.00	24,000.00	Line # 547
4	8-inch P.V.C. on M 9 1/2 N (from M 5 W to M 4 1/2 W)	2600	L.F.	16.00	41,600.00	Line # 557
5	8-inch P.V.C. on M 4 1/2 W (from M 9 N to M 9 1/2 N)	2600	L.F.	16.00	41,600.00	Line # 558
6	8-inch P.V.C. on M 3 1/2 W (from M 9 N to M 9 1/4 N)	1300	L.F.	16.00	20,800.00	Line # 559
7	8-inch P.V.C. on M 9 1/4 N (from M 3 W to M 3 1/2 W)	2600	L.F.	16.00	41,600.00	Line # 560
8	8-inch P.V.C. on M 3 W (from M 9 N to M 9 1/4 N)	1300	L.F.	16.00	20,800.00	Line # 561
9	Canal Crossing on M 4 1/2 W (Line # 558)	1	LS	20,000.00	20,000.00	
10	Expressway Crossing on M 3 1/2 W (Line # 545)	1	LS	20,000.00	20,000.00	
11	Highway Crossing (FM 88 - Line # 557)	1	LS	10,000.00	10,000.00	
TOTAL FOR NORTHEAST IMPROVEMENTS					\$338,000.00	

CHAPTER 4

PROJECT SCHEDULE & IMPLEMENTATION PLAN

1. Implementation Plan

A. Five Year Schedule of System Improvements

This section presents a preliminary schedule for implementing the proposed improvements. It is to be noted that various factors, namely, availability of funds, growth pattern, etc., influence the sequence of the schedule. However, an attempt is made to prioritize the improvements based on the best engineering judgement and the results obtained from computer modeling. Table 4.1 shows the breakdown of the improvements and the cost estimates.

Priority was assigned based on the current and future requirements. Top most priority was given to upgrade the current system so as to provide fire protection and to comply with the State Regulations. Adding lines to form major grid was given next priority followed by and tasks such as constructing lines to complete minor loops and outer loops (for future connections).

B. Potential Funding Sources

a) State Support (If eligible)

TEXAS WATER DEVELOPMENT FUND (580.013)

OBJECTIVES:

Provide loans to eligible applicants for engineering and construction of local or regional water supply, wastewater treatment, flood control and municipal solid waste projects.

TYPES OF ASSISTANCE:

Direct loans at approximately .35 of one percent above the board's borrowing cost. Repayment period is generally 20 to 25 years.

USES AND USE RESTRICTIONS:

Land acquisition, easements, engineering and environmental consultants (for planning, design and construction), construction, inspection and project administration; water wells, retail distribution and wholesale transmission lines, storage tanks and water treatment plants; wastewater collection lines and treatment facilities; storm water retention basins, channel modifications, bridge modifications, flood plain land acquisition, relocation of residents in flood plains, and development of flood plain management plans.

APPLICANT ELIGIBILITY:

Political subdivisions (cities, counties, districts and river authorities) or non-profit water

supply corporations.

APPLICANT PROCEDURE:

Contact the board to schedule pre-application conference. Submit an application including general, fiscal, legal, engineering and environmental information.

DEADLINES:

First working day of the month preceding the month during which the application will be considered by the board. Generally, the board meets on the third Thursday of each month to consider applications.

FORMULA AND MATCHING REQUIREMENTS:

No matching requirements.

RANGE AND AVERAGE OF FINANCIAL

N/A

REGIONAL OR LOCAL OFFICE:

None.

AGENCY OFFICE:

Texas Water Development Board
P.O. Box 13231
Austin, Texas 78711-3231

b) Local Funding

At this time, no local funds are available for implementation of the project. When it is required, it is assumed that the City may apply for loan funds from the State, like the one described above, or will sell revenue bonds. It is suggested that the City implement a rate study to determine the actual increase in cost per connection, if any, to implement the proposed improvements..

c) User Fee

The City's current water rate structure is as follows:

Residential In-City

minimum	\$ 7.00
Per 1000 gallons or portion thereof	\$ 1.40

Residential Outside City

Minimum	\$ 11.50
Per 1000 gallons or portion thereof	\$ 1.40

Commercial Users

Minimum	\$ 7.00
15,001 to 35,000 gallons	\$ 17.00
35,001 gallons and over	\$ 27.00
Per 1000 gallons or portion thereof	
0 to 15,000 gallons	\$ 1.40
15,001 gallons and over	\$ 1.59

Table 4.1

**Priority Schedule of the Proposed Improvements
City of Weslaco**

Year 1996 - 1997

Item	Item Description	Location	Cost (Current Year) (1996)	Cost (Project Year)	Remarks
1	12-inch on M 6 W (Line # 489)	Southwest	\$18,000.00	\$18,000.00	Provides Fire Protection
2	12-inch on M 6 W (Line # 490)	Southwest	\$24,000.00	\$24,000.00	Provides Fire Protection
3	12-inch on M 6 W (Line # 491 & 492)	Southwest	\$37,000.00	\$37,000.00	Provides Fire Protection
4	8-inch on M 5 N (Line # 522)	Southwest	\$41,600.00	\$41,600.00	Provides Fire Protection
5	8-inch on M 5 1/2 W (Line # 525)	Southwest	\$22,400.00	\$22,400.00	Provides Fire Protection
6	8-inch on M 5 1/4 N (Line # 526)	Southwest	\$20,800.00	\$20,800.00	Provides Fire Protection
7	8-inch on M 5 1/4 W (Line # 527)	Southwest	\$20,800.00	\$20,800.00	Provides Fire Protection
8	8-inch on Wimbledon Dr. (Line # 528)	Southwest	\$10,400.00	\$10,400.00	Provides Fire Protection
9	Patchwork for Elevated Tank # 1		\$75,000.00	\$75,000.00	
10	Altitude Valve at Tank # 1		\$20,000.00	\$20,000.00	Provide better operational aspects
11	Auxiliary Power Unit at Plant		\$25,000.00	\$25,000.00	Comply with TNRCC regulations
12	Computer System & Software		\$5,000.00	\$5,000.00	For updating the network model
13	Water Lines at Expressway Heights	Northwest	\$170,000.00	\$170,000.00	Funds already allocated
	Subtotal		\$490,000.00	\$490,000.00	
	Contingency (15%)		\$73,500.00	\$73,500.00	
	Engineering (7%)		\$34,300.00	\$34,300.00	
	TOTAL IMPROVEMENTS FOR 1996-97		\$597,800.00	\$597,800.00	

Table 4.1 (Continued..)

Priority Schedule of the Proposed Improvements
City of Weslaco

Year 1997 - 1998

Item	Item Description	Location	Cost (Current Year) (1996)	Cost (Project Year)	Remarks
1	6-inch on M 4 1/4 W (Line 533)	Southeast	\$7,000.00	\$7,210.00	
2	6-inch on Erasmo Dr. (Line # 534)	Southeast	\$2,800.00	\$2,884.00	
3	8-inch on M 3 1/2 W (Line # 536)	Southeast	\$25,600.00	\$26,368.00	
4	8-inch on M 3 1/2 W (Line # 537)	Southeast	\$41,600.00	\$42,848.00	
5	8-inch on M 3 1/2 W (Line # 538)	Southeast	\$44,800.00	\$46,144.00	
6	8-inch on M 4 W (Line # 539)	Southeast	\$41,600.00	\$42,848.00	
7	Suspended Ditch Crossing (Line # 539)	Southeast	\$10,000.00	\$10,300.00	
8	8-inch on M 5 1/2 N (Line # 540)	Southeast	\$20,800.00	\$21,424.00	
9	8-inch on M 5 1/2 N (Line # 541)	Southeast	\$20,800.00	\$21,424.00	
10	8-inch on M 5 1/2 W (Line # 542 & 543)	Southeast	\$41,600.00	\$42,848.00	
11	Suspended Ditch Crossing (Line # 542)	Southeast	\$10,000.00	\$10,300.00	
12	8-inch from Expy.-Corpus C Dr. (Line #549)	Northwest	\$9,600.00	\$9,888.00	
13	8-inch on M 6 W (Line 562)	Northwest	\$44,800.00	\$46,144.00	
14	8-inch on M 3 1/2 W (Line # 545)	Northeast	\$64,000.00	\$65,920.00	
15	Expy. Crossing (Line # 545)	Northeast	\$20,000.00	\$20,600.00	
16	8-inch on M 4 W (Line # 546)	Northeast	\$33,600.00	\$34,608.00	
17	8-inch on M 4 W (Line 547)	Northeast	\$24,000.00	\$24,720.00	
	Subtotal		\$462,600.00	\$476,478.00	
	Contingency (15%)		\$69,390.00	\$71,471.70	
	Engineering (7%)		\$32,382.00	\$33,353.46	
	TOTAL IMPROVEMENTS FOR 1997-98		\$564,372.00	\$581,303.16	

Table 4.1 (Continued..)

Priority Schedule of the Proposed Improvements
City of Weslaco

Year 1998 - 1999

Item	Item Description	Location	Cost (Current Year) (1996)	Cost (Project Year)	Remarks
1	8-inch S. of Quail Hollow (Line # 529)	Southwest	\$27,200.00	\$28,856.48	
2	6-inch NW of Southland Hts. (Line # 530)	Southwest	\$12,600.00	\$13,367.34	
3	8-inch on M 6 N (Line # 531 & 532)	Southeast	\$37,600.00	\$39,889.84	
4	8-inch SW of Siesta Village (Line # 535)	Southeast	\$7,200.00	\$7,638.48	
5	6-inch SW of RoEllen (Line # 544)	Southeast	\$14,000.00	\$14,852.60	
6	Suspended Ditch Crossing (Line # 544)	Southeast	\$10,000.00	\$10,609.00	
7	6-inch on Pena Avenue (Line # 548)	Northwest	\$11,200.00	\$11,882.08	
8	8-inch on Corpus Christ Dr. (Line # 550)	Northwest	\$10,400.00	\$11,033.36	
9	8-inch from Anaqua St. (Line # 551)	Northwest	\$35,200.00	\$37,343.68	
10	Elevated Canal Crossing (Line # 551)	Northwest	\$20,000.00	\$21,218.00	
	Subtotal		\$185,400.00	\$196,690.86	
	Contingency (15%)		\$27,810.00	\$29,503.63	
	Engineering (7%)		\$12,978.00	\$13,768.36	
	TOTAL IMPROVEMENTS FOR 1998-99		\$226,188.00	\$239,962.85	

Table 4.1 (Continued..)

**Priority Schedule of the Proposed Improvements
City of Weslaco**

Year 1999-2000

Item	Item Description	Location	Cost (Current Year) (1996)	Cost (Project Year)	Remarks
1	8-inch on M 5 N (Line # 523)	Southwest	\$41,600.00	\$45,457.44	
2	Suspended Ditch Crossing (Line # 523)	Southwest	\$10,000.00	\$10,927.27	
3	8-inch on M 5 N (Line # 524)	Southeast	\$41,600.00	\$45,457.44	
4	Suspended Ditch Crossing (Line # 524)	Southeast	\$10,000.00	\$10,927.27	
5	8-inch on M 6 1/2 W (Line # 552)	Northwest	\$60,800.00	\$66,437.80	
6	8-inch on M 9 N (Line # 553)	Northwest	\$41,600.00	\$45,457.44	
7	Elevated Canal Crossing (Line # 553)	Northwest	\$20,000.00	\$21,854.54	
8	8-inch on M 5 1/4 W (Line # 554)	Northwest	\$24,000.00	\$26,225.45	
9	8-inch on M 9 1/2 N (Line # 555)	Northwest	\$21,600.00	\$23,602.90	
10	12-inch on M 5 W (Line # 556)	Northwest	\$30,000.00	\$32,781.81	
11	8-inch on M 9 1/2 N (Line # 557)	Northeast	\$41,600.00	\$45,457.44	
12	Highway Crossing (Line 557)	Northeast	\$10,000.00	\$10,927.27	
13	8-inch on M 4 1/2 W (Line # 558)	Northeast	\$41,600.00	\$45,457.44	
14	Canal Crossing (Line # 558)	Northeast	\$20,000.00	\$21,854.54	
15	8-inch on M 3 1/2 W (Line # 559)	Northeast	\$20,800.00	\$22,728.72	
16	8-inch on M 9 1/4 N (Line # 560)	Northeast	\$41,600.00	\$45,457.44	
17	8-inch on M 3 W (Line # 561)	Northeast	\$20,800.00	\$22,728.72	
	Subtotal		\$497,600.00	\$543,740.96	
	Contingency (15%)		\$74,640.00	\$81,561.14	
	Engineering (7%)		\$34,832.00	\$38,061.87	
	TOTAL IMPROVEMENTS FOR 1999-2000		\$607,072.00	\$663,363.97	

Table 4.1 (Continued..)

Priority Schedule of the Proposed Improvements
City of Weslaco

Year 2000-2001

Item	Item Description	Location	Cost (Current Year) (1996)	Cost (Project Year)	Remarks
1	8-inch on M 6 1/4 N (Line # 564)	Southwest	\$36,800.00	\$41,418.72	
2	Suspended Ditch Crossing (Line # 564)	Southwest	\$10,000.00	\$11,255.09	
3	Elevated Canal Crossing (Line # 564)	Southwest	\$20,000.00	\$22,510.18	
4	0.5 MG Elevated Water Tank	Southwest	\$500,000.00	\$562,754.41	
5	Engineering Study for New Plant		\$75,000.00	\$84,413.16	
	Subtotal		\$641,800.00	\$722,351.55	
	Contingency (15%)		\$96,270.00	\$108,352.73	
	Engineering (7%)		\$44,926.00	\$50,564.61	
	TOTAL IMPROVEMENTS FOR 2000-2001		\$782,996.00	\$881,268.90	

Beyond Year 2001

Item	Item Description	Location	Cost (Current Year) (1996)	Cost (Project Year)	Remarks
1	3.0 MG Water Plant Addition	Exist. Plant	\$3,000,000.00		If required.
	Subtotal		\$3,000,000.00		Cost not pro-rated for the year of Implementation.
	Contingency (15%)		\$450,000.00		
	Engineering (7%)		\$210,000.00		
	TOTAL IMPROVEMENTS FOR 2000-2001		\$3,660,000.00		

Notes:

Cost for Project Year is estimated by considering a 3% inflation rate per year.

CHAPTER 5

CONCLUSIONS

The existing water supply, treatment, and distribution systems of the City of Weslaco were evaluated for current and future conditions. It was found that the existing 7.5 MGD treatment plant is capable of handling not only the current demand but also immediate future demand.

The existing network system has few bottle necks that cause significant head losses in the system. These bottlenecks cause the system pressure to fall below 20 psi during an event of fire in Southwest and Southeast areas of the City. These lines were identified and improvements were proposed. Also, improvements were proposed to upgrade the system to provide required minimum pressure for current and as well as future demand.

It is very important for the City to study the system behavior as and when there is a rapid increase in demand in a particular area (due to the advent of a major consumer such as industrial or large commercial establishments). It is suggested that the City acquire necessary computing facilities to update the model time to time or hire an engineer to check the system behavior.

Finally, this report is intended for discussions and study purposes only. The existing conditions shown in the report might vary and should be determined and established for design and construction purposes.

APPENDICES

**MODEL INPUT
EXISTING SYSTEM - CURRENT DEMAND**

```

*****
*   K Y P I P E 2   *
*   University of Kentucky Hydraulic Analysis Program *
*   Distribution of Pressure and Flows in Piping Networks *
*   1000 PIPE VERSION - 1.10   (08/25/92) *
*****

```

DATE: 9/30/1996
TIME: 16:26: 5

INPUT DATA FILENAME ----- c:\ky\ESCD.DAT
TABULATED OUTPUT FILENAME ----- c:\ky\ESCD.OUT
POSTPROCESSOR RESULTS FILENAME --- c:\ky\ESCD.RES

```

*****
S U M M A R Y   O F   O R I G I N A L   D A T A
*****

```

U N I T S S P E C I F I E D

FLOWRATE = gallons/minute
HEAD (HGL) = feet
PRESSURE = psig

P I P E L I N E D A T A

STATUS CODE: XX -CLOSED PIPE FG -FIXED GRADE NODE PU -PUMP LINE
CV -CHECK VALVE RV -REGULATING VALVE

PIPE NUMBER	NODE #1	NODE #2	LENGTH (ft)	DIAMETER (in)	ROUGHNESS COEFF.	MINOR LOSS COEFF.	FGN-HGL (ft)
1	1	2	2700.0	8.0	100.00	.00	
2	2	3	1760.0	8.0	100.00	.00	
3	3	4	830.0	8.0	100.00	.00	
4	4	5	2130.0	8.0	100.00	.00	
5	5	6	2140.0	8.0	100.00	.00	
6	6	7	350.0	6.0	100.00	.00	
7	7	8	330.0	6.0	100.00	.00	
8	8	9	350.0	6.0	100.00	.00	
9	9	10	200.0	6.0	100.00	.00	
10	10	11	850.0	6.0	100.00	.00	
11	11	12	200.0	2.0	100.00	.00	
12	12	9	850.0	6.0	100.00	.00	
13	12	13	650.0	2.0	100.00	.00	
14	13	14	1200.0	6.0	100.00	.00	
15	14	7	320.0	6.0	100.00	.00	
16	4	15	340.0	8.0	100.00	.00	
17	15	16	1100.0	2.0	100.00	.00	
18	16	17	600.0	8.0	100.00	.00	
19	17	18	1100.0	2.0	100.00	.00	
20	18	15	600.0	8.0	100.00	.00	
21	3	19	1630.0	6.0	100.00	.00	
22	19	3	2460.0	6.0	100.00	.00	
23	2	20	350.0	6.0	100.00	.00	
24	20	21	870.0	6.0	100.00	.00	
25	21	22	380.0	6.0	100.00	.00	
26	22	23	840.0	4.0	100.00	.00	
27	20	23	500.0	6.0	100.00	.00	
28	23	24	650.0	6.0	100.00	.00	
29	24	25	520.0	4.0	100.00	.00	
30	25	26	650.0	4.0	100.00	.00	
31	23	26	520.0	6.0	100.00	.00	
32	26	30	160.0	6.0	100.00	.00	
33	30	27	1170.0	6.0	100.00	.00	
34	27	28	1170.0	6.0	100.00	.00	
35	28	29	1000.0	6.0	100.00	.00	

36	29	30	450.0	6.0	100.00	.00
37	29	31	320.0	6.0	100.00	.00
38	31	28	1070.0	4.0	100.00	.00
39	26	32	1150.0	6.0	100.00	.00
40	32	33	1000.0	6.0	100.00	.00
41	33	34	440.0	6.0	100.00	.00
42	34	35	640.0	4.0	100.00	.00
43	35	36	500.0	4.0	100.00	.00
44	32	36	500.0	6.0	100.00	.00
45	36	37	300.0	6.0	100.00	.00
46	37	38	650.0	6.0	100.00	.00
47	38	39	600.0	6.0	100.00	.00
48	39	34	290.0	6.0	100.00	.00
49	38	35	290.0	6.0	100.00	.00
50	39	40	650.0	6.0	100.00	.00
51	38	41	300.0	6.0	100.00	.00
52	1	42	2600.0	8.0	100.00	.00
53	42	43	250.0	4.0	100.00	.00
54	43	44	500.0	2.0	100.00	.00
55	44	45	500.0	2.0	100.00	.00
56	45	46	770.0	4.0	100.00	.00
57	46	47	500.0	4.0	100.00	.00
58	47	44	770.0	6.0	100.00	.00
59	47	48	530.0	4.0	100.00	.00
60	48	43	770.0	4.0	100.00	.00
61	48	42	1000.0	8.0	100.00	.00
62	48	49	830.0	8.0	100.00	.00
63	48	49	830.0	4.0	100.00	.00
64	47	50	830.0	6.0	100.00	.00
65	46	51	600.0	4.0	100.00	.00
66	51	50	730.0	2.0	100.00	.00
67	50	49	500.0	2.0	100.00	.00
68	50	52	1050.0	6.0	100.00	.00
69	52	49	550.0	8.0	100.00	.00
70	52	53	300.0	8.0	100.00	.00
71	53	54	450.0	8.0	100.00	.00
72	54	55	700.0	12.0	100.00	.00
73	55	56	100.0	8.0	100.00	.00
74	56	57	450.0	8.0	100.00	.00
75	57	56	450.0	8.0	100.00	.00
76	55	58	1500.0	12.0	100.00	.00
77	58	59	300.0	12.0	100.00	.00
78	59	60	300.0	6.0	100.00	.00
79	60	61	200.0	6.0	100.00	.00
80	61	62	450.0	6.0	100.00	.00
81	62	63	750.0	6.0	100.00	.00
82	63	64	570.0	6.0	100.00	.00
83	64	65	600.0	6.0	100.00	.00
84	65	60	950.0	6.0	100.00	.00
85	58	66	2600.0	12.0	100.00	.00
86	66	67	2600.0	12.0	100.00	.00
87	67	6	3150.0	8.0	100.00	.00
88	67	68	2150.0	12.0	100.00	.00
89	68	69	950.0	6.0	100.00	.00
90	69	70	800.0	6.0	100.00	.00
91	68	71	2250.0	12.0	100.00	.00
92	71	72	1300.0	8.0	100.00	.00
93	72	73	1400.0	8.0	100.00	.00
94	73	74	800.0	8.0	100.00	.00
95	74	75	200.0	8.0	100.00	.00
96	75	76	1150.0	6.0	100.00	.00
97	76	97	700.0	4.0	100.00	.00
98	97	96	600.0	4.0	100.00	.00
99	97	95	900.0	4.0	100.00	.00
100	95	94	350.0	8.0	100.00	.00
101	96	93	1150.0	6.0	100.00	.00
102	94	93	500.0	8.0	100.00	.00
103	94	93	1100.0	6.0	100.00	.00
104	92	93	500.0	8.0	100.00	.00
105	92	82	750.0	12.0	100.00	.00
106	92	83	800.0	12.0	100.00	.00
107	83	59	2000.0	12.0	100.00	.00
108	82	81	650.0	12.0	100.00	.00
109	81	91	500.0	8.0	100.00	.00
110	91	90	920.0	8.0	100.00	.00

111	90	91	950.0	8.0	100.00	.00
112	81	84	800.0	12.0	100.00	.00
113	81	80	850.0	8.0	100.00	.00
114	80	79	400.0	8.0	100.00	.00
115	78	79	700.0	8.0	100.00	.00
116	78	109	850.0	8.0	100.00	.00
117	78	77	1350.0	8.0	100.00	.00
118	77	73	1350.0	8.0	100.00	.00
119	85	79	750.0	8.0	100.00	.00
120	85	84	1300.0	8.0	100.00	.00
121	85	86	1200.0	8.0	100.00	.00
122	86	87	1250.0	16.0	100.00	.00
123-FG	87	0	1200.0	16.0	100.00	.00
124	87	84	1200.0	12.0	100.00	.00
125	87	88	600.0	8.0	100.00	.00
126	88	89	700.0	6.0	100.00	.00
127	88	98	700.0	8.0	100.00	.00
128	98	99	770.0	8.0	100.00	.00
129	99	109	850.0	8.0	100.00	.00
130	109	53	1000.0	8.0	100.00	.00
131	99	108	200.0	6.0	100.00	.00
132	108	100	150.0	6.0	100.00	.00
133	100	101	300.0	2.0	100.00	.00
134	101	106	1000.0	2.0	100.00	.00
135	101	102	290.0	6.0	100.00	.00
136	102	105	950.0	6.0	100.00	.00
137	102	103	435.0	6.0	100.00	.00
138	103	104	970.0	6.0	100.00	.00
139	104	105	500.0	6.0	100.00	.00
140	105	106	300.0	6.0	100.00	.00
141	106	107	300.0	2.0	100.00	.00
142	107	100	1100.0	6.0	100.00	.00
143	98	110	1100.0	8.0	100.00	.00
144	110	111	1600.0	12.0	100.00	.00
145	111	112	1550.0	8.0	100.00	.00
146	112	113	650.0	6.0	100.00	.00
147	112	114	1270.0	8.0	100.00	.00
148	114	115	800.0	8.0	100.00	.00
149	115	116	350.0	8.0	100.00	.00
150	116	117	1750.0	6.0	100.00	.00
151	116	118	850.0	8.0	100.00	.00
152	118	119	600.0	8.0	100.00	.00
153	119	120	250.0	6.0	100.00	.00
154	120	121	1650.0	6.0	100.00	.00
155	121	120	600.0	6.0	100.00	.00
156	121	122	250.0	6.0	100.00	.00
157	122	119	600.0	8.0	100.00	.00
158	114	123	1050.0	6.0	100.00	.00
159	123	124	800.0	6.0	100.00	.00
160	124	125	1900.0	6.0	100.00	.00
161	125	124	1400.0	6.0	100.00	.00
162	123	133	1050.0	6.0	100.00	.00
163	133	132	250.0	6.0	100.00	.00
164	132	131	550.0	2.0	100.00	.00
165	131	132	400.0	6.0	100.00	.00
166	130	127	1360.0	6.0	100.00	.00
167	130	129	310.0	6.0	100.00	.00
168	128	129	1520.0	6.0	100.00	.00
169	127	128	280.0	8.0	100.00	.00
170	126	127	800.0	8.0	100.00	.00
171	126	134	2650.0	6.0	100.00	.00
172	134	135	900.0	6.0	100.00	.00
173	135	136	950.0	6.0	100.00	.00
174	135	137	850.0	12.0	100.00	.00
175	137	138	350.0	8.0	100.00	.00
176	138	139	450.0	6.0	100.00	.00
177	139	140	700.0	6.0	100.00	.00
178	140	141	550.0	8.0	100.00	.00
179	140	141	1600.0	6.0	100.00	.00
180	141	144	700.0	6.0	100.00	.00
181	139	144	400.0	6.0	100.00	.00
182	138	140	1100.0	8.0	100.00	.00
183	145	144	120.0	6.0	100.00	.00
184	145	143	320.0	8.0	100.00	.00
185	142	141	500.0	8.0	100.00	.00

210.00

186	142	143	630.0	6.0	100.00	.00
187	142	143	2260.0	8.0	100.00	.00
188	137	146	850.0	12.0	100.00	.00
189	146	145	400.0	8.0	100.00	.00
190	146	147	1850.0	12.0	100.00	.00
191	147	148	200.0	6.0	100.00	.00
192	148	149	370.0	6.0	100.00	.00
193	149	150	370.0	6.0	100.00	.00
194	150	151	900.0	6.0	100.00	.00
195	151	152	400.0	4.0	100.00	.00
196	149	153	400.0	6.0	100.00	.00
197	153	152	660.0	4.0	100.00	.00
198	152	155	450.0	6.0	100.00	.00
199	148	154	400.0	6.0	100.00	.00
200	154	155	850.0	4.0	100.00	.00
201	147	155	1500.0	6.0	100.00	.00
202	134	156	4000.0	12.0	100.00	.00
203	157	156	1300.0	12.0	100.00	.00
204	157	158	2600.0	12.0	100.00	.00
205	157	159	600.0	8.0	100.00	.00
206	159	160	900.0	6.0	100.00	.00
207	160	161	400.0	8.0	100.00	.00
208	161	162	1200.0	6.0	100.00	.00
209	162	163	850.0	8.0	100.00	.00
210	163	164	500.0	8.0	100.00	.00
211	164	166	850.0	12.0	100.00	.00
212	165	170	1750.0	8.0	100.00	.00
213	166	169	650.0	12.0	100.00	.00
214	166	167	500.0	12.0	100.00	.00
215	167	168	650.0	4.0	100.00	.00
216	168	169	500.0	8.0	100.00	.00
217	169	170	650.0	12.0	100.00	.00
218	170	111	1350.0	12.0	100.00	.00
219	172	171	650.0	8.0	100.00	.00
220	172	87	1450.0	8.0	100.00	.00
221	172	173	650.0	8.0	100.00	.00
222	174	86	1450.0	8.0	100.00	.00
223	78	175	1050.0	12.0	100.00	.00
224	176	175	800.0	12.0	100.00	.00
225	177	178	450.0	8.0	100.00	.00
226	178	85	1200.0	8.0	100.00	.00
227	179	86	850.0	16.0	100.00	.00
228	179	180	550.0	6.0	100.00	.00
229	180	181	700.0	6.0	100.00	.00
230	181	182	550.0	8.0	100.00	.00
231	182	183	700.0	8.0	100.00	.00
232	182	174	550.0	8.0	100.00	.00
233	174	184	700.0	8.0	100.00	.00
234	183	184	550.0	8.0	100.00	.00
235	183	186	650.0	8.0	100.00	.00
236	184	185	650.0	8.0	100.00	.00
237	186	185	550.0	8.0	100.00	.00
238	186	187	350.0	8.0	100.00	.00
239	187	188	700.0	8.0	100.00	.00
240	188	189	350.0	6.0	100.00	.00
241	190	189	1450.0	6.0	100.00	.00
242	190	200	1550.0	12.0	100.00	.00
243	188	192	600.0	6.0	100.00	.00
244	192	191	1400.0	8.0	100.00	.00
245	192	193	600.0	6.0	100.00	.00
246	193	359	1400.0	8.0	100.00	.00
247	193	194	650.0	6.0	100.00	.00
248	194	195	700.0	6.0	100.00	.00
249	194	196	350.0	6.0	100.00	.00
250	196	197	950.0	6.0	100.00	.00
251	196	198	350.0	6.0	100.00	.00
252	197	198	600.0	4.0	100.00	.00
253	199	198	750.0	6.0	100.00	.00
254	199	164	500.0	12.0	100.00	.00
255	200	199	650.0	12.0	100.00	.00
256	200	201	500.0	8.0	100.00	.00
257	201	162	300.0	8.0	100.00	.00
258	202	160	450.0	8.0	100.00	.00
259	202	203	1000.0	6.0	100.00	.00
260	202	205	350.0	8.0	100.00	.00

261	203	204	500.0	6.0	100.00	.00	
262	204	205	800.0	8.0	100.00	.00	
263	205	159	150.0	8.0	100.00	.00	
264	206	204	150.0	8.0	100.00	.00	
265	206	208	1200.0	4.0	100.00	.00	
266	207	208	1000.0	8.0	100.00	.00	
267	208	209	1000.0	8.0	100.00	.00	
268	209	190	200.0	12.0	100.00	.00	
269	207	206	300.0	8.0	100.00	.00	
270	210	209	600.0	12.0	100.00	.00	
271	213	189	400.0	8.0	100.00	.00	
272	213	214	700.0	8.0	100.00	.00	
273	214	215	320.0	8.0	100.00	.00	
274	214	187	700.0	8.0	100.00	.00	
275	215	186	700.0	8.0	100.00	.00	
276	215	216	650.0	8.0	100.00	.00	
277	216	183	700.0	8.0	100.00	.00	
278	217	182	900.0	8.0	100.00	.00	
279	217	218	1500.0	8.0	100.00	.00	
280	218	225	1100.0	18.0	100.00	.00	
281	178	219	600.0	8.0	100.00	.00	
282	176	224	600.0	12.0	100.00	.00	
283	218	179	200.0	16.0	100.00	.00	
284	221	222	600.0	4.0	100.00	.00	
285	222	223	1100.0	4.0	100.00	.00	
286	223	220	250.0	6.0	100.00	.00	
287	220	219	350.0	12.0	100.00	.00	
288	219	224	600.0	12.0	100.00	.00	
289	224	221	500.0	12.0	100.00	.00	
290	220	225	1300.0	12.0	100.00	.00	
291	226	225	1300.0	12.0	100.00	.00	
292	226	217	600.0	12.0	100.00	.00	
293	217	227	1900.0	8.0	100.00	.00	
294	226	227	1600.0	8.0	100.00	.00	
295	227	236	400.0	8.0	100.00	.00	
296	227	228	200.0	8.0	100.00	.00	
297	228	214	950.0	8.0	100.00	.00	
298	228	229	600.0	8.0	100.00	.00	
299	241	213	600.0	8.0	100.00	.00	
300	229	241	300.0	8.0	100.00	.00	
301	241	231	1350.0	6.0	100.00	.00	
302	231	230	850.0	12.0	100.00	.00	
303	230	229	300.0	6.0	100.00	.00	
304	230	229	300.0	8.0	100.00	.00	
305	230	235	600.0	12.0	100.00	.00	
306	235	228	300.0	8.0	100.00	.00	
307	235	236	200.0	12.0	100.00	.00	
308	236	237	300.0	12.0	100.00	.00	
309	237	234	700.0	16.0	100.00	.00	
310	237	239	200.0	12.0	100.00	.00	
311	239	238	300.0	8.0	100.00	.00	
312-FG	238	0	500.0	8.0	100.00	.00	210.00
313	239	240	1150.0	12.0	100.00	.00	
314	240	226	450.0	12.0	100.00	.00	
315	240	262	1300.0	8.0	100.00	.00	
316	260	234	1900.0	16.0	100.00	.00	
317	234	233	1200.0	8.0	100.00	.00	
318	233	230	700.0	6.0	100.00	.00	
319	233	232	1000.0	6.0	100.00	.00	
320	232	231	980.0	10.0	100.00	.00	
321	231	212	1150.0	12.0	100.00	.00	
322	212	210	400.0	12.0	100.00	.00	
323	210	211	650.0	8.0	100.00	.00	
324	242	208	2900.0	8.0	100.00	.00	
325	242	249	1350.0	8.0	100.00	.00	
326	242	243	2700.0	8.0	100.00	.00	
327	243	244	400.0	12.0	100.00	.00	
328	243	158	3100.0	12.0	100.00	.00	
329-FG	244	0	3400.0	12.0	100.00	.00	210.00
330	244	245	1600.0	12.0	100.00	.00	
331	245	246	1300.0	12.0	100.00	.00	
332	246	247	650.0	4.0	100.00	.00	
333	247	248	1100.0	6.0	100.00	.00	
334	248	249	800.0	6.0	100.00	.00	
335	249	250	1250.0	8.0	100.00	.00	

336	246	295	400.0	12.0	100.00	.00
337	246	250	1300.0	6.0	100.00	.00
338	250	251	380.0	8.0	100.00	.00
339	251	252	800.0	6.0	100.00	.00
340	251	253	2250.0	8.0	100.00	.00
341	253	254	750.0	8.0	100.00	.00
342	254	288	700.0	6.0	100.00	.00
343	288	289	550.0	6.0	100.00	.00
344	288	287	400.0	6.0	100.00	.00
345	254	255	600.0	8.0	100.00	.00
346	255	256	600.0	8.0	100.00	.00
347	256	257	750.0	8.0	100.00	.00
348	256	258	650.0	6.0	100.00	.00
349	258	259	600.0	6.0	100.00	.00
350	255	259	650.0	8.0	100.00	.00
351	259	260	500.0	8.0	100.00	.00
352	260	261	1350.0	8.0	100.00	.00
353	261	264	1300.0	8.0	100.00	.00
354	261	262	1300.0	8.0	100.00	.00
355	262	263	1300.0	8.0	100.00	.00
356	263	225	1780.0	18.0	100.00	.00
357	264	263	1280.0	18.0	100.00	.00
358	264	265	1450.0	8.0	100.00	.00
359	265	266	600.0	6.0	100.00	.00
360	266	269	650.0	8.0	100.00	.00
361	266	267	650.0	6.0	100.00	.00
362	269	268	650.0	6.0	100.00	.00
363	270	281	3100.0	8.0	100.00	.00
364	270	271	1500.0	8.0	100.00	.00
365	270	274	2650.0	12.0	100.00	.00
366	273	272	900.0	6.0	100.00	.00
367	273	71	3100.0	12.0	100.00	.00
368	273	274	3000.0	12.0	100.00	.00
369	276	274	920.0	12.0	100.00	.00
370	276	275	2550.0	8.0	100.00	.00
371	279	277	2550.0	6.0	100.00	.00
372	278	279	250.0	16.0	100.00	.00
373	279	280	550.0	16.0	100.00	.00
374	280	270	800.0	16.0	100.00	.00
375	280	281	2650.0	8.0	100.00	.00
376	279	282	2650.0	16.0	100.00	.00
377	282	283	2600.0	16.0	100.00	.00
378	283	264	1400.0	18.0	100.00	.00
379	284	260	2000.0	16.0	100.00	.00
380	284	285	630.0	8.0	100.00	.00
381	286	298	1080.0	6.0	100.00	.00
382	297	298	650.0	6.0	100.00	.00
383	297	290	860.0	12.0	100.00	.00
384	290	291	2850.0	12.0	100.00	.00
385	291	292	300.0	12.0	100.00	.00
386	292	293	520.0	12.0	100.00	.00
387	293	250	480.0	12.0	100.00	.00
388	250	295	900.0	12.0	100.00	.00
389	295	294	400.0	8.0	100.00	.00
390	294	293	900.0	8.0	100.00	.00
391	292	294	1220.0	8.0	100.00	.00
392	294	296	650.0	8.0	100.00	.00
393	299	300	650.0	6.0	100.00	.00
394	305	306	800.0	6.0	100.00	.00
395	300	301	400.0	2.0	100.00	.00
396	301	302	650.0	6.0	100.00	.00
397	299	302	400.0	4.0	100.00	.00
398	302	303	400.0	8.0	100.00	.00
399	304	284	300.0	16.0	100.00	.00
400	285	304	900.0	4.0	100.00	.00
401	303	304	300.0	16.0	100.00	.00
402	303	305	650.0	16.0	100.00	.00
403	300	306	150.0	6.0	100.00	.00
404	305	307	1100.0	16.0	100.00	.00
405	283	308	2600.0	18.0	100.00	.00
406	309	282	1800.0	8.0	100.00	.00
407	310	278	2500.0	12.0	100.00	.00
408	313	278	1150.0	16.0	100.00	.00
409	313	314	1800.0	8.0	100.00	.00
410	314	315	1300.0	6.0	100.00	.00

411	315	276	2050.0	12.0	100.00	.00	
412	316	315	2300.0	12.0	100.00	.00	
413	317	316	2650.0	12.0	100.00	.00	
414	317	312	1600.0	16.0	100.00	.00	
415	312	313	1000.0	16.0	100.00	.00	
416	312	311	1300.0	8.0	100.00	.00	
417	318	311	1600.0	8.0	100.00	.00	
418	318	317	1300.0	16.0	100.00	.00	
419	319	318	1550.0	16.0	100.00	.00	
420	319	310	2200.0	12.0	100.00	.00	
421	310	311	300.0	8.0	100.00	.00	
422	320	309	2500.0	8.0	100.00	.00	
423	320	319	1150.0	16.0	100.00	.00	
424	321	320	1100.0	16.0	100.00	.00	
425	334	321	200.0	16.0	100.00	.00	
426	321	322	400.0	6.0	100.00	.00	
427	322	323	450.0	6.0	100.00	.00	
428	308	323	900.0	6.0	100.00	.00	
429	324	308	300.0	18.0	100.00	.00	
430	324	326	420.0	6.0	100.00	.00	
431	325	324	300.0	18.0	100.00	.00	
432	326	327	950.0	4.0	100.00	.00	
433	327	328	200.0	6.0	100.00	.00	
434	328	325	1200.0	6.0	100.00	.00	
435	332	325	300.0	18.0	100.00	.00	
436	332	331	500.0	6.0	100.00	.00	
437	333	332	300.0	18.0	100.00	.00	
438	331	329	500.0	4.0	100.00	.00	
439	329	328	350.0	6.0	100.00	.00	
440	333	330	1000.0	6.0	100.00	.00	
441	334	333	150.0	18.0	100.00	.00	
442	351	334	2300.0	18.0	100.00	.00	
443	335	307	900.0	18.0	100.00	.00	
444	335	336	330.0	12.0	100.00	.00	
445	336	337	620.0	12.0	100.00	.00	
446	337	338	650.0	12.0	100.00	.00	
447	338	339	180.0	12.0	100.00	.00	
448	339	340	1200.0	12.0	100.00	.00	
449	340	297	3300.0	12.0	100.00	.00	
450	341	342	450.0	4.0	100.00	.00	
451	339	342	750.0	4.0	100.00	.00	
452	338	344	1180.0	6.0	100.00	.00	
453	342	343	550.0	6.0	100.00	.00	
454	343	341	950.0	6.0	100.00	.00	
455	344	343	350.0	6.0	100.00	.00	
456	344	345	1650.0	6.0	100.00	.00	
457	345	346	380.0	12.0	100.00	.00	
458	346	347	350.0	6.0	100.00	.00	
459	346	335	800.0	12.0	100.00	.00	
460	348	347	650.0	6.0	100.00	.00	
461	336	348	150.0	6.0	100.00	.00	
462	348	349	650.0	6.0	100.00	.00	
463	337	349	170.0	6.0	100.00	.00	
464	349	347	1450.0	6.0	100.00	.00	
465	350	335	400.0	18.0	100.00	.00	
466	351	350	250.0	18.0	100.00	.00	
467	352	351	20.0	18.0	100.00	.00	
468	353	352	20.0	18.0	100.00	.00	
469	354	353	10.0	18.0	100.00	.00	
470-XXPU	0	352	35.0	18.0	100.00	.00	70.00
471-FGPU	0	353	10.0	18.0	100.00	.00	70.00
472-XXPU	0	354	10.0	18.0	100.00	.00	70.00
473-FGPU	0	355	10.0	18.0	100.00	.00	70.00
474-XXPU	0	356	10.0	18.0	100.00	.00	70.00
475	355	356	10.0	18.0	100.00	.00	
476	356	357	50.0	18.0	100.00	.00	
477	357	350	200.0	18.0	100.00	.00	
478	195	358	1350.0	8.0	100.00	.00	
479	358	359	1350.0	8.0	100.00	.00	
480	173	359	1050.0	8.0	100.00	.00	
481	269	360	600.0	8.0	100.00	.00	
482	360	361	700.0	8.0	100.00	.00	
483	340	362	2200.0	8.0	100.00	.00	
484	362	363	800.0	8.0	100.00	.00	
485	249	364	2700.0	8.0	100.00	.00	

486	364	212	1600.0	8.0	100.00	.00
487	167	365	800.0	12.0	100.00	.00
488	365	126	1400.0	12.0	100.00	.00

P U M P D A T A

THERE IS A PUMP TYPE 1 IN THE FOLLOWING PIPES:
473

DESCRIBED BY THE FOLLOWING DATA:

HEAD (ft)	FLOWRATE (gpm)
165.00	.00
150.00	475.00
125.00	1000.00

THERE IS A PUMP TYPE 2 IN THE FOLLOWING PIPES:
474

DESCRIBED BY THE FOLLOWING DATA:

HEAD (ft)	FLOWRATE (gpm)
325.00	.00
250.00	1300.00
125.00	2400.00

THERE IS A PUMP TYPE 3 IN THE FOLLOWING PIPES:
471

DESCRIBED BY THE FOLLOWING DATA:

HEAD (ft)	FLOWRATE (gpm)
325.00	.00
250.00	1300.00
125.00	2400.00

THERE IS A PUMP TYPE 4 IN THE FOLLOWING PIPES:
472

DESCRIBED BY THE FOLLOWING DATA:

HEAD (ft)	FLOWRATE (gpm)
290.00	.00
240.00	1500.00
120.00	3400.00

THERE IS A PUMP TYPE 5 IN THE FOLLOWING PIPES:
470

DESCRIBED BY THE FOLLOWING DATA:

HEAD (ft)	FLOWRATE (gpm)
240.00	.00
200.00	2400.00
140.00	4200.00

J U N C T I O N N O D E D A T A

JUNCTION NUMBER	JUNCTION TITLE	EXTERNAL DEMAND (gpm)	JUNCTION ELEVATION (ft)	CONNECTING PIPES
1	M 5 N & BRID	.00	77.00	1 52
2		69.00	69.00	1 2 23
3		48.00	70.00	2 3 21 22

4		38.00	68.00	3	4	16		
5	M 5 N & FM 1	12.00	70.00	4	5			
6		70.00	70.00	5	6	87		
7		.00	70.00	6	7	15		
8		.00	70.00	7	8			
9		.00	70.00	8	9	12		
10	SIESTA VILLA	.00	70.00	9	10			
11		.00	70.00	10	11			
12		.00	70.00	11	12	13		
13		.00	70.00	13	14			
14		.00	70.00	14	15			
15	AGUA DULCE H	.00	70.00	16	17	20		
16		.00	70.00	17	18			
17		.00	70.00	18	19			
18		.00	70.00	19	20			
19		.00	70.00	21	22			
20	R.C. BABB UN	.00	69.50	23	24	27		
21		.00	70.00	24	25			
22		.00	70.00	25	26			
23		.00	70.00	26	27	28	31	
24		.00	70.00	28	29			
25	R.C. BABB UN	.00	72.00	29	30			
26		.00	71.00	30	31	32	39	
27		.00	73.00	33	34			
28		.00	73.00	34	35	38		
29		.00	71.00	35	36	37		
30	R.C. BABB UN	.00	71.00	32	33	36		
31		.00	73.00	37	38			
32		50.00	70.00	39	40	44		
33		.00	70.00	40	41			
34		.00	70.00	41	42	48		
35	CUELLAR SUBD	.00	70.00	42	43	49		
36		.00	70.00	43	44	45		
37		.00	70.00	45	46			
38		.00	70.00	46	47	49	51	
39		.00	70.00	47	48	50		
40	CUELLAR SUBD	.00	70.00	50				
41		.00	70.00	51				
42		19.00	77.00	52	53	61		
43		.00	76.00	53	54	60		
44		.00	76.00	54	55	58		
45	RANCHERO VIL	.00	76.00	55	56			
46		.00	78.00	56	57	65		
47		.00	77.00	57	58	59	64	
48		.00	77.00	59	60	61	62	63
49		14.00	77.50	62	63	67	69	
50	TRAILS END M	.00	77.50	64	66	67	68	
51		.00	78.50	65	66			
52		5.00	78.00	68	69	70		
53		23.00	77.50	70	71	130		
54		.00	77.00	71	72			
55	MARGO TERRAC	10.00	78.00	72	73	76		
56		.00	78.00	73	74	75		
57		.00	77.00	74	75			
58		.00	70.00	76	77	85		
59		30.00	70.00	77	78	107		
60	COUNTRY SUNS	.00	70.00	78	79	84		
61		.00	69.00	79	80			
62		.00	68.00	80	81			
63		.00	67.00	81	82			
64		.00	67.00	82	83			
65	COUNTRY SUNS	.00	66.00	83	84			
66		.00	68.00	85	86			
67		3.00	69.00	86	87	88		
68		.00	73.00	88	89	91		
69		5.00	71.00	89	90			
70	SOUTH PALM G	.00	70.00	90				
71		34.00	75.00	91	92	367		
72		17.00	78.00	92	93			
73		5.00	78.00	93	94	118		
74		.00	78.00	94	95			
75	CAMELOT VILL	21.00	78.00	95	96			
76		18.00	75.00	96	97			
77		1.00	77.00	117	118			
78		9.00	74.00	115	116	117	223	

79		1.00	75.00	114	115	119	
80	7th & JAMES	8.00	74.50	113	114		
81		12.00	74.00	108	109	112	113
82		10.00	74.00	105	108		
83		16.00	75.00	106	107		
84		.00	75.00	112	120	124	
85	6th & UTAH A	57.00	74.00	119	120	121	226
86		13.00	74.20	121	122	222	227
87	ELEV. TANK #	8.00	73.00	122	123	124	125 220
88		11.00	71.00	125	126	127	
89		.00	70.50	126			
90	ROELLEN SUBD	.00	69.00	110	111		
91		.00	74.00	109	110	111	
92		16.00	74.50	104	105	106	
93		.00	74.00	101	102	103	104
94		.00	74.00	100	102	103	
95	JO-LEINE SUB	.00	74.00	99	100		
96		.00	74.00	98	101		
97		.00	74.00	97	98	99	
98		34.00	79.50	127	128	143	
99		47.00	82.00	128	129	131	
100	GARDEN TERRA	.00	81.50	132	133	142	
101		.00	81.00	133	134	135	
102		.00	81.00	135	136	137	
103		.00	79.00	137	138		
104		.00	66.00	138	139		
105	GARDEN TERRA	.00	68.00	136	139	140	
106		.00	68.00	134	140	141	
107		.00	67.50	141	142		
108		.00	81.00	131	132		
109		5.00	78.00	116	129	130	
110	12th & OREGO	3.00	77.00	143	144		
111		1.00	80.00	144	145	218	
112		3.00	80.00	145	146	147	
113		.00	79.00	146			
114		25.00	77.00	147	148	158	
115	LIVE OAK SUB	6.00	76.00	148	149		
116		7.00	76.00	149	150	151	
117		.00	76.00	150			
118		13.00	78.00	151	152		
119		.00	80.00	152	153	157	
120	HIDDEN VALLE	.00	78.00	153	154	155	
121		.00	73.00	154	155	156	
122		.00	73.00	156	157		
123		.00	79.00	158	159	162	
124		17.00	80.20	159	160	161	
125	SOUTHLAND HE	.00	82.00	160	161		
126		111.00	77.00	170	171	488	
127		11.00	73.00	166	169	170	
128		.00	73.00	168	169		
129		.00	74.00	167	168		
130	QUAIL HOLLOW	.00	74.00	166	167		
131		.00	76.00	164	165		
132		.00	76.00	163	164	165	
133		.00	76.00	162	163		
134		.00	76.00	171	172	202	
135	M 6 W & CITR	.00	79.00	172	173	174	
136		.00	79.00	173			
137		26.00	77.00	174	175	188	
138		.00	77.00	175	176	182	
139		.00	76.00	176	177	181	
140	WESTGATE WOO	.00	76.00	177	178	179	182
141		.00	76.00	178	179	180	185
142		.00	76.00	185	186	187	
143		.00	73.00	184	186	187	
144		.00	74.00	180	181	183	
145	WESTGATE WOO	.00	74.00	183	184	189	
146		.00	74.20	188	189	190	
147		42.00	72.00	190	191	201	
148		.00	72.00	191	192	199	
149		.00	72.00	192	193	196	
150	BELLAIRE SUB	.00	72.00	193	194		
151		.00	76.00	194	195		
152		.00	77.00	195	197	198	
153		.00	74.00	196	197		

154		.00	74.00	199	200		
155	BELLAIRE SUB	.00	76.00	198	200	201	
156		6.00	80.00	202	203		
157		19.00	76.00	203	204	205	
158		.00	79.00	204	328		
159		15.00	75.00	205	206	263	
160	HACKBERRY &	.00	80.00	206	207	258	
161		.00	80.00	207	208		
162		6.00	75.00	208	209	257	
163		.00	80.00	209	210		
164		18.00	79.00	210	211	254	
165	11th & BORDE	.00	79.00	212			
166		34.00	75.50	211	213	214	
167		.00	77.00	214	215	487	
168		.00	77.00	215	216		
169		.00	75.50	213	216	217	
170	12th & OKLAH	18.00	78.00	212	217	218	
171		.00	74.00	219			
172		12.00	76.00	219	220	221	
173		11.00	81.00	221	480		
174		1.00	78.00	222	232	233	
175	T10 AVE.	12.00	74.00	223	224		
176		.00	74.50	224	282		
177		.00	74.00	225			
178		25.00	74.00	225	226	281	
179		4.00	74.00	227	228	283	
180	GRAY'S LN. &	1.00	74.00	228	229		
181		8.00	74.00	229	230		
182		15.00	78.00	230	231	232	278
183		6.00	78.00	231	234	235	277
184		8.00	80.00	233	234	236	
185	6th & TEXAS	1.00	82.00	236	237		
186		1.00	79.00	235	237	238	275
187		.00	81.00	238	239	274	
188		15.00	82.00	239	240	243	
189		6.00	81.50	240	241	271	
190	4th & BORDER	22.00	75.50	241	242	268	
191		5.00	78.00	244			
192		18.00	78.00	243	244	245	
193		19.00	77.00	245	246	247	
194		14.00	75.00	247	248	249	
195	10th & INDIA	25.00	76.00	248	478		
196		20.00	80.00	249	250	251	
197		10.00	80.00	250	252		
198		4.00	80.00	251	252	253	
199		7.00	80.00	253	254	255	
200	7TH & BORDER	24.00	80.00	242	255	256	
201		21.00	80.00	256	257		
202		28.00	75.00	258	259	260	
203		.00	75.00	259	261		
204		3.00	75.00	261	262	264	
205	6th & CLIFFO	.00	75.00	260	262	263	
206		.00	75.00	264	265	269	
207		25.00	82.00	266	269		
208		17.00	81.00	265	266	267	324
209		.00	79.00	267	268	270	
210	2nd & BORDER	6.00	81.00	270	322	323	
211		.00	83.00	323			
212		.00	81.00	321	322	486	
213		4.00	79.50	271	272	299	
214		1.00	78.00	272	273	274	297
215	3rd & TEXAS	.00	77.00	273	275	276	
216		1.00	77.00	276	277		
217		16.00	74.00	278	279	292	293
218		5.00	74.00	279	280	283	
219		21.00	74.00	281	287	288	
220	2nd & UTAH A	18.00	76.00	286	287	290	
221		.00	78.00	284	289		
222		.00	76.50	284	285		
223		16.00	79.00	285	286		
224		.00	76.00	282	288	289	
225	2nd & BRIDGE	134.00	73.50	280	290	291	356
226		.00	74.50	291	292	294	314
227		4.00	75.00	293	294	295	296
228		29.00	76.00	296	297	298	306

229		.00	76.50	298	300	303	304	
230	1st & CALLE	16.00	76.00	302	303	304	305	318
231		.00	80.00	301	302	320	321	
232		.00	78.50	319	320			
233		71.00	76.00	317	318	319		
234		62.00	74.20	309	316	317		
235	1st & CALLE	6.00	80.00	305	306	307		
236		.00	80.00	295	307	308		
237		.00	78.00	308	309	310		
238	ELEV. TANK #	5.00	79.00	311	312			
239		.00	76.00	310	311	313		
240	1st & GARZA	16.00	75.00	313	314	315		
241		.00	75.00	299	300	301		
242		.00	84.00	324	325	326		
243		.00	82.00	326	327	328		
244		.00	81.00	327	329	330		
245	M 8 N & M 6.	.00	87.00	330	331			
246		7.00	85.00	331	332	336	337	
247		.00	85.00	332	333			
248		.00	85.00	333	334			
249		.00	84.00	325	334	335	485	
250	M 8 N & M 6	.00	81.00	335	337	338	387	388
251		.00	75.00	338	339	340		
252		.00	75.00	339				
253		23.00	76.00	340	341			
254		53.00	75.00	341	342	345		
255	W PIKE & CAL	15.00	75.00	345	346	350		
256		.00	75.00	346	347	348		
257		2.00	75.00	347				
258		32.00	72.00	348	349			
259		43.00	75.00	349	350	351		
260	W PIKE & TEX	122.00	76.00	316	351	352	379	
261		2.00	83.00	352	353	354		
262		47.00	75.00	315	354	355		
263		101.00	74.00	355	356	357		
264		45.00	76.00	353	357	358	378	
265	E PIKE & UTA	47.00	75.00	358	359			
266		.00	71.00	359	360	361		
267		.00	75.00	361				
268		.00	73.00	362				
269		.00	71.00	360	362	481		
270	M 8 N & M 3.	3.00	69.00	363	364	365	374	
271		1.00	70.00	364				
272		.00	70.00	366				
273		16.00	70.00	366	367	368		
274		.00	68.00	365	368	369		
275	CENTER POINT	.00	65.00	370				
276		29.00	68.00	369	370	411		
277		.00	68.00	371				
278		.00	68.00	372	407	408		
279		.00	68.00	371	372	373	376	
280	M 3.5 W & SE	5.00	70.00	373	374	375		
281		.00	66.50	363	375			
282		.00	66.00	376	377	406		
283		3.00	72.00	377	378	405		
284		19.00	82.00	379	380	399		
285	PENA & NEBRA	.00	75.00	380	400			
286		6.00	73.00	381				
287		.00	72.00	344				
288		1.00	73.00	342	343	344		
289		.00	74.00	343				
290	EXPWAY 83 &	1.00	73.00	383	384			
291		1.00	74.00	384	385			
292		3.00	76.00	385	386	391		
293		5.00	73.00	386	387	390		
294		.00	78.00	389	390	391	392	
295	JONES DAVIS	.00	81.00	336	388	389		
296		7.00	79.00	392				
297		6.00	73.00	382	383	449		
298		.00	73.00	381	382			
299		.00	82.00	393	397			
300	DELMA ST. &	.00	85.00	393	395	403		
301		.00	85.00	395	396			
302		10.00	81.00	396	397	398		
303		17.00	82.00	398	401	402		

304		.00	80.00	399	400	401
305	DELMA ST. &	59.00	81.00	394	402	404
306		.00	86.00	394	403	
307		8.00	81.00	404	443	
308		.00	67.00	405	428	429
309		.00	67.00	406	422	
310	WESLACO AIRP	.00	68.00	407	420	421
311		.00	67.50	416	417	421
312		.00	67.00	414	415	416
313		.00	68.00	408	409	415
314		.00	69.00	409	410	
315	SHOW TO SUN	13.00	69.00	410	411	412
316		2.00	67.00	412	413	
317		14.00	66.00	413	414	418
318		.00	67.00	417	418	419
319		2.00	67.00	419	420	423
320	M 9 N & NW O	.00	67.00	422	423	424
321		20.00	68.00	424	425	426
322		.00	66.50	426	427	
323		.00	67.00	427	428	
324		.00	67.00	429	430	431
325	TEJAS TRES S	32.00	67.00	431	434	435
326		.00	68.00	430	432	
327		.00	72.00	432	433	
328		.00	72.00	433	434	439
329		.00	71.00	438	439	
330	HERITAGE SQ.	.00	70.00	440		
331		.00	68.00	436	438	
332		.00	67.00	435	436	437
333		5.00	67.00	437	440	441
334		.00	67.00	425	441	442
335	M 9 N & TEXA	.00	80.00	443	444	459 465
336		34.00	77.00	444	445	461
337		.00	75.00	445	446	463
338		24.00	77.00	446	447	452
339		.00	78.00	447	448	451
340	M 9 N & CANA	3.00	80.50	448	449	483
341		.00	80.00	450	454	
342		.00	79.00	450	451	453
343		.00	76.00	453	454	455
344		.00	77.00	452	455	456
345	TEXAS BLVD.	.00	76.00	456	457	
346		20.00	78.00	457	458	459
347		.00	79.00	458	460	464
348		.00	77.00	460	461	462
349		.00	78.00	462	463	464
350	M 9 N @ SW O	2.00	80.00	465	466	477
351		.00	79.00	442	466	467
352	PUMP # 5	.00	79.00	467	468	470
353	PUMP # 3	.00	79.00	468	469	471
354	PUMP # 4	.00	79.00	469	472	
355	PUMP # 1	.00	80.00	473	475	
356	PUMP # 2	.00	80.00	474	475	476
357		14.00	80.00	476	477	
358	10th & TEXAS	13.00	77.50	478	479	
359	7th & TEXAS	26.00	79.00	246	479	480
360		33.00	71.00	481	482	
361		.00	71.00	482		
362		.00	80.00	483	484	
363		.00	80.00	484		
364		.00	80.00	485	486	
365		.00	82.00	487	488	

OUTPUT OPTION DATA

OUTPUT SELECTION: ALL RESULTS ARE INCLUDED IN THE TABULATED OUTPUT
 MAXIMUM AND MINIMUM PRESSURES = 15
 MAXIMUM AND MINIMUM VELOCITIES = 15
 MAXIMUM AND MINIMUM HEAD LOSS/1000 = 15

SYSTEM CONFIGURATION

NUMBER OF PIPES(p) = 488
NUMBER OF JUNCTION NODES(j) = 365
NUMBER OF PRIMARY LOOPS(l) = 116
NUMBER OF FIXED GRADE NODES(f) = 8
NUMBER OF SUPPLY ZONES(z) = 1

JUNCTION/NODE DEMAND

TABLE **

Water Distribution System Model
City of Weslaco

Junction Data

Assumed No. of Persons per Lot:	3.5	Assumed/calculated Per-Capita Average Demand:	110 gpcd
---------------------------------	-----	---	----------

Node	Elev.	Subd. & Lots		Subd. & Lots		Subd. & Lots		Total Lots	Avg. Dmd Res. (gpm)	Known Avg. Flows (gpm)		Known Avg. Flows (gpm)		Avg. Dmd Misc. (gpm)	Total Avg. Dmd (gpm)
		Name	Lots	Name	Lots	Name	Lots			Name	Flow	Name	Flow		
1								0	0						0
2		R.C. Babb Units	257					257	69						69
3		Llano Grande Home	179					179	48						48
4		Agua Dulce # 1	49	Agua Dulce # 2	49	Los Castillos Est.	44	142	38						38
5								0	0	Ballards Lk. View Pk.	9	Methodist Thicket	3		12
6								0	0	Siesta Village*	70				70
7								0	0						0
8								0	0						0
9								0	0						0
10								0	0						0
11								0	0						0
12								0	0						0
13								0	0						0
14								0	0						0
15								0	0						0
16								0	0						0
17								0	0						0
18								0	0						0
19								0	0						0
20								0	0						0
21								0	0						0
22								0	0						0
23								0	0						0
24								0	0						0
25								0	0						0
26								0	0						0
27								0	0						0
28								0	0						0
29								0	0						0

TABLE **

Water Distribution System Model
City of Weslaco

Junction Data

Assumed No. of Persons per Lot:	3.5	Assumed/calculated Per-Capita Average Demand:	110 gpcd
---------------------------------	-----	---	----------

Node	Elev.	Subd. & Lots		Subd. & Lots		Subd. & Lots		Total Lots	Avg. Dmd Res. (gpm)	Known Avg. Flows (gpm)		Known Avg. Flows (gpm)		Avg. Dmd Misc. (gpm)	Total Avg. Dmd (gpm)
		Name	Lots	Name	Lots	Name	Lots			Name	Flow	Name	Flow		
30								0	0						0
31								0	0						0
32		Cuellar Subds. 1 & 2	187					187	50						50
33								0	0						0
34								0	0						0
35								0	0						0
36								0	0						0
37								0	0						0
38								0	0						0
39								0	0						0
40								0	0						0
41								0	0						0
42		Angela Subd.	65					65	17	Dream world Apts.	2				19
43								0	0						0
44								0	0						0
45								0	0						0
46								0	0						0
47								0	0						0
48								0	0						0
49								0	0	Ranchero Vill. M. H.	14				14
50								0	0						0
51								0	0						0
52								0	0	Trails End East MH.	5				5
53		Kathaleen Park	32					32	9	Margo Main Bldg.	5	Wesl. Village	9		23
54								0	0						0
55		Margo Terrace	39					39	10						10
56								0	0						0
57								0	0						0
58								0	0						0

TABLE **

Water Distribution System Model
City of Weslaco

Junction Data

Assumed No. of Persons per Lot: 3.5 Assumed/calculated Per-Capita Average Demand: 110 gpcd

Node	Elev.	Subd. & Lots		Subd. & Lots		Subd. & Lots		Total Lots	Avg. Dmd Res. (gpm)	Known Avg. Flows (gpm)		Known Avg. Flows (gpm)		Avg. Dmd Misc. (gpm)	Total Avg. Dmd (gpm)
		Name	Lots	Name	Lots	Name	Lots			Name	Flow	Name	Flow		
59								0	0	Country Sunshine Pk	30				30
60								0	0						0
61								0	0						0
62								0	0						0
63								0	0						0
64								0	0						0
65								0	0						0
66								0	0						0
67								0	0	USDA Admin. Office	3				3
68								0	0						0
69		South Palm Garden	18					18	5						5
70								0	0						0
71								0	0	Pine to Palm Res. Pk.	22	Magic Valley Mobile	11	1	34
72								0	0	TX. A&M Expt. St.	14	Tx. A & I	2	1	17
73								0	0	Texana Pickle Prod.	4			1	5
74								0	0						0
75		Camelot Village	77					77	21						21
76		Kaymar	68					68	18						18
77								0	0					1	1
78								0	0	Pronto Car Wash	4	Maytag Laundry	4	1	9
79								0	0					1	1
80		James M. Black # 1	30					30	8						8
81		James M. Black # 2	44					44	12						12
82		Ro-Ellen Subds.	26					26	7	McAllen Kidney Cen	3				10
83								0	0	S Comfort Resort Pk	16				16
84								0	0						0
85								0	0	Knapp Med. Center	56			1	57
86								0	0	Harlom Park	6	Weslaco T P	7		13
87				Sunrise Subd.	24			24	6	Louise Black Elem.	2				8

TABLE **

Water Distribution System Model
City of Weslaco

Junction Data

Assumed No. of Persons per Lot: 3.5 Assumed/calculated Per-Capita Average Demand: 110 gpcd

Node	Elev.	Subd. & Lots		Subd. & Lots		Subd. & Lots		Total Lots	Avg. Dmd Res. (gpm)	Known Avg. Flows (gpm)		Known Avg. Flows (gpm)		Avg. Dmd Misc. (gpm)	Total Avg. Dmd (gpm)
		Name	Lots	Name	Lots	Name	Lots			Name	Flow	Name	Flow		
88				Jo Lynn Add	20	Wanda	20	40	11						11
89								0	0						0
90								0	0						0
91								0	0						0
92		Jo-Lene Subds.	60					60	16						16
93								0	0						0
94								0	0						0
95								0	0						0
96								0	0						0
97								0	0						0
98								0	0	Val. Grnd. Acad. etc	34				34
99		Garden Terrace	164					164	44	S. Bridge M H	3				47
100								0	0						0
101								0	0						0
102								0	0						0
103								0	0						0
104								0	0						0
105								0	0						0
106								0	0						0
107								0	0						0
108								0	0						0
109								0	0	Bridge Hollow Apts.	3	Kingswood Apts.	2		5
110		Glens Subd.	12					12	3						3
111								0	0					1	1
112		Laurel Subd.	12					12	3						3
113								0	0						0
114		Live Oak Subd.	59					59	16	Leisure World M H	9				25
115								0	0	Trails End MH	6				6
116		Magic Valley Trian.	27					27	7						7

TABLE **

Water Distribution System Model
City of Weslaco

Junction Data

Assumed No. of Persons per Lot:	3.5	Assumed/calculated Per-Capita Average Demand:	110 gpcd
---------------------------------	-----	---	----------

Node	Elev.	Subd. & Lots		Subd. & Lots		Subd. & Lots		Total Lots	Avg. Dmd Res. (gpm)	Known Avg. Flows (gpm)		Known Avg. Flows (gpm)		Avg. Dmd Misc. (gpm)	Total Avg. Dmd (gpm)
		Name	Lots	Name	Lots	Name	Lots			Name	Flow	Name	Flow		
117								0	0						0
118		Chapparal Subd.	8	Hidden Valley	42			50	13						13
119								0	0						0
120								0	0						0
121								0	0						0
122								0	0						0
123								0	0						0
124		Southland Heights	64					64	17						17
125								0	0						0
126		Sun Valley Estates	32					32	9	Military HWY Water	96	Mem. Main Bldg.	6		111
127		Quail Hollow	43					43	11						11
128								0	0						0
129								0	0						0
130								0	0						0
131								0	0						0
132								0	0						0
133								0	0						0
134								0	0						0
135								0	0						0
136								0	0						0
137		Westgate Woods	98					98	26						26
138								0	0						0
139								0	0						0
140								0	0						0
141								0	0						0
142								0	0						0
143								0	0						0
144								0	0						0
145								0	0						0

TABLE **

Water Distribution System Model
City of Weslaco

Junction Data

Assumed No. of Persons per Lot: 3.5 Assumed/calculated Per-Capita Average Demand: 110 gpcd

Node	Elev.	Subd. & Lots		Subd. & Lots		Subd. & Lots		Total Lots	Avg. Dmd Res. (gpm)	Known Avg. Flows (gpm)		Known Avg. Flows (gpm)		Avg. Dmd Misc. (gpm)	Total Avg. Dmd (gpm)
		Name	Lots	Name	Lots	Name	Lots			Name	Flow	Name	Flow		
146								0	0						0
147		Bellaire Subd.	158					158	42						42
148								0	0						0
149								0	0						0
150								0	0						0
151								0	0						0
152								0	0						0
153								0	0						0
154								0	0						0
155								0	0						0
156								0	0	Camelot Condos.	3	Cozy Candos.	3		6
157								0	0	Casa De Amigos	16	Kings Village Apts.	3		19
158								0	0						0
159		Brixey Subd.	32					32	9	Jones Guy etc.	2	Magic Valley Savs.	4		15
160								0	0						0
161								0	0						0
162		Jones Vos	24					24	6						6
163								0	0						0
164		Palm Terrace	20	Christine	47			67	18						18
165								0	0						0
166		Rowena Subd.	24					24	6	John Knox Village	28				34
167								0	0						0
168								0	0						0
169								0	0						0
170		Cassel 1 & 2	67					67	18						18
171								0	0						0
172		Mary Dix	15	East Hollywood	29			44	12						12
173		Unknown Subd.	8	Unknown Subd.	17			25	7			Central Main Bldg.	4		11
174								0	0	Casa De Oro Apts.	1				1

TABLE **

Water Distribution System Model
City of Weslaco

Junction Data

Assumed No. of Persons per Lot:	3.5	Assumed/calculated Per-Capita Average Demand:	110 gpcd
---------------------------------	-----	---	----------

Node	Elev.	Subd. & Lots		Subd. & Lots		Subd. & Lots		Total Lots	Avg. Dmd Res. (gpm)	Known Avg. Flows (gpm)		Known Avg. Flows (gpm)		Avg. Dmd Misc. (gpm)	Total Avg. Dmd (gpm)
		Name	Lots	Name	Lots	Name	Lots			Name	Flow	Name	Flow		
175		Davenport 1 & 2	40					40	11					1	12
176								0	0						0
177								0	0						0
178								0	0	McManus Produce	25				25
179								0	0	Flora Motel	2	Wesl. Bolt & Supply	1	1	4
180								0	0					1	1
181		Mistelete Subd.	28					28	7					1	8
182		OTS 28-31,44,45	57					57	15						15
183		OTS 32,27	20					20	5					1	6
184		OTS 48	19	OTS 49	9			28	7					1	8
185								0	0					1	1
186								0	0					1	1
187								0	0						0
188		OTS 39	17	OTS 38	23			40	11			Adm. Bus. Office	4		15
189		OTS 22	10	OTS 23	12			22	6						6
190		OTS 6	32	Glendale Subd.	28	Mills Subd.	24	84	22						22
191		OTS 4	18					18	5						5
192		OTS 2	18	OTS 3	18	OTS 52, 53	30	66	18						18
193		OTS 54	24	OTS 55	24			48	13	Wesl. Housing Aut.	6				19
194		Orange Grove	52					52	14						14
195		Highland Subd.	94					94	25						25
196		Bluebonnet	52	Jamison	24			76	20						20
197		Sunset	20	Yoder Subd.	17			37	10						10
198		McCollum	15					15	4						4
199		West Side	25					25	7						7
200		Pike Hooke Subd.	46			Bouganville Hts.	20	66	18	Mid Valley Paving	6				24
201		Greenbriar Estates	80					80	21						21
202		Barklay Reil	36	Sunset Terrace	25	Unknown	45	106	28						28
203								0	0						0

TABLE **

Water Distribution System Model
City of Weslaco

Junction Data

Assumed No. of Persons per Lot:	3.5	Assumed/calculated Per-Capita Average Demand:	110 gpcd
---------------------------------	-----	---	----------

Node	Elev.	Subd. & Lots		Subd. & Lots		Subd. & Lots		Total Lots	Avg. Dmd Res. (gpm)	Known Avg. Flows (gpm)		Known Avg. Flows (gpm)		Avg. Dmd Misc. (gpm)	Total Avg. Dmd (gpm)
		Name	Lots	Name	Lots	Name	Lots			Name	Flow	Name	Flow		
204		Tres Palmas Subd.	11					11	3						3
205								0	0						0
206								0	0						0
207		Ashmont & Madeline	18	Virginia Terrace	45	Unknown	30	93	25						25
208		Valleyview hts. etc.	65					65	17						17
209								0	0						0
210		West Hwy.	24					24	6						6
211								0	0						0
212								0	0						0
213		Unknown	10					10	3					1	4
214								0	0					1	1
215								0	0						0
216								0	0					1	1
217								0	0	Gulf Distributing	16				16
218								0	0	Williamson Dickie	5				5
219		Guadalupe	80					80	21						21
220		Bailey Subd.	66					66	18						18
221								0	0						0
222								0	0						0
223		Canal Heights	27	Vans	32			59	16						16
224								0	0						0
225		James M. Black	144	East Side	96	Ramona & Colonia	262	502	134						134
226								0	0						0
227								0	0	L.C. Olivarez	4				4
228		Unknown	108					108	29						29
229								0	0						0
230		Unknown	60					60	16						16
231								0	0						0
232								0	0						0

TABLE **

Water Distribution System Model
City of Weslaco

Junction Data

Assumed No. of Persons per Lot:	3.5	Assumed/calculated Per-Capita Average Demand:	110 gpcd
---------------------------------	-----	---	----------

Node	Elev.	Subd. & Lots		Subd. & Lots		Subd. & Lots		Total Lots	Avg. Dmd Res. (gpm)	Known Avg. Flows (gpm)		Known Avg. Flows (gpm)		Avg. Dmd Misc. (gpm)	Total Avg. Dmd (gpm)
		Name	Lots	Name	Lots	Name	Lots			Name	Flow	Name	Flow		
233		Christensens	265					265	71						71
234		Nortside etc.	180	Gonzalez	48			228	61				1		62
235		Unknown	20					20	5				1		6
236								0	0						0
237								0	0						0
238		Unknown	15					15	4				1		5
239								0	0						0
240		Palamo	44					44	12	Horton School	4				16
241								0	0						0
242								0	0						0
243								0	0						0
244								0	0						0
245								0	0						0
246								0	0	Rio Valley MH Pk.	7				7
247								0	0						0
248								0	0						0
249								0	0						0
250								0	0						0
251								0	0						0
252								0	0						0
253								0	0	High School	23				23
254		Lackland etc.	140	Unknown	60			200	53						53
255		Hughes etc.	55					55	15						15
256								0	0						0
257								0	0	Wesl. Boys Club	2				2
258		Unknown	120					120	32						32
259		Unknown	154					154	41	Val. Baptist Church	2				43
260		Fresno	28	White, Morgon etc.	330			358	96	HEB & Vicinity	25		1		122
261								0	0	Sam Houston Elem.	2				2

TABLE **

Water Distribution System Model
City of Weslaco

Junction Data

Assumed No. of Persons per Lot: 3.5 Assumed/calculated Per-Capita Average Demand: 110 gpcd

Node	Elev.	Subd. & Lots		Subd. & Lots		Subd. & Lots		Total Lots	Avg. Dmd Res. (gpm)	Known Avg. Flows (gpm)		Known Avg. Flows (gpm)		Avg. Dmd Misc. (gpm)	Total Avg. Dmd (gpm)
		Name	Lots	Name	Lots	Name	Lots			Name	Flow	Name	Flow		
262		Villa Vista	56	Plaza Pk. & Vicinity	119			175	47						47
263		Roosevelt Sch. Ad.	40	Ramona & Vicinity	228	Villa Vista	108	376	101						101
264		Villa Vista	92	Subd. A	44	Subd. B	27	163	44					1	45
265		El Tejano Subd.	168					168	45	KRGV	1			1	47
266								0	0						0
267								0	0						0
268								0	0						0
269								0	0						0
270								0	0	S. Tx. Vo Tech.	3				3
271								0	0					1	1
272								0	0						0
273								0	0	Palm Aire Motel	15			1	16
274								0	0						0
275								0	0						0
276		Center Point Subd.	107					107	29						29
277								0	0						0
278								0	0						0
279								0	0						0
280								0	0	Wesl. Cutting Center	5				5
281								0	0						0
282								0	0						0
283								0	0	N. Bridge Irrig.	2			1	3
284		Citrus Terrace	34	Feliza Pena	34			68	18					1	19
285								0	0						0
286								0	0	Golden Corrol	6				6
287								0	0						0
288								0	0					1	1
289								0	0						0
290								0	0					1	1

TABLE **

Water Distribution System Model
City of Weslaco

Junction Data

Assumed No. of Persons per Lot: 3.5 Assumed/calculated Per-Capita Average Demand: 110 gpcd

Node	Elev.	Subd. & Lots		Subd. & Lots		Subd. & Lots		Total Lots	Avg. Dmd Res. (gpm)	Known Avg. Flows (gpm)		Known Avg. Flows (gpm)		Avg. Dmd Misc. (gpm)	Total Avg. Dmd (gpm)
		Name	Lots	Name	Lots	Name	Lots			Name	Flow	Name	Flow		
291								0	0					1	1
292								0	0	Tx. State Bank	2			1	3
293								0	0	K-Mart	5				5
294								0	0						0
295								0	0						0
296								0	0	Luby's	7				7
297		De La Pena # 2	21					21	6						6
298								0	0						0
299								0	0						0
300								0	0						0
301								0	0						0
302		Turberville Subd.	36					36	10						10
303		Ballard Subdivision	65					65	17						17
304								0	0						0
305		De La Pena	36					36	10	Wesl. Labor Camp	48			1	59
306								0	0						0
307		De Weslaco	7	Col. San Fransisco	24			31	8						8
308								0	0						0
309								0	0						0
310								0	0						0
311								0	0						0
312								0	0						0
313								0	0						0
314								0	0						0
315								0	0	Snow to Sun T P	11	A N Rico Elem.	2		13
316								0	0	Mary Hoge Main Bld.	2				2
317								0	0	Adjutant Gen. Dept.	14				14
318								0	0						0
319								0	0	Mid Valley Airport	2				2

TABLE **

Water Distribution System Model
City of Weslaco

Junction Data

Assumed No. of Persons per Lot: 3.5 Assumed/calculated Per-Capita Average Demand: 110 gpcd

Node	Elev.	Subd. & Lots		Subd. & Lots		Subd. & Lots		Total Lots	Avg. Dmd Res. (gpm)	Known Avg. Flows (gpm)		Known Avg. Flows (gpm)		Avg. Dmd Misc. (gpm)	Total Avg. Dmd (gpm)
		Name	Lots	Name	Lots	Name	Lots			Name	Flow	Name	Flow		
320								0	0						0
321		Heritage Sq. # 1	75					75	20						20
322								0	0						0
323								0	0						0
324								0	0						0
325		Tejas Tres Subd.	119					119	32						32
326								0	0						0
327								0	0						0
328								0	0						0
329								0	0						0
330								0	0						0
331								0	0						0
332								0	0						0
333		Heritage Sq. # 2	17					17	5						5
334								0	0						0
335								0	0						0
336		Tejas Development	129					129	34						34
337								0	0						0
338		Tejas Dos	89					89	24						24
339								0	0						0
340								0	0	Clecker Heald	3				3
341								0	0						0
342								0	0						0
343								0	0						0
344								0	0						0
345								0	0						0
346		Diana Subd.	76					76	20						20
347								0	0						0
348								0	0						0

TABLE **

Water Distribution System Model
City of Weslaco

Junction Data

Assumed No. of Persons per Lot: 3.5 Assumed/calculated Per-Capita Average Demand: 110 gpcd

Node	Elev.	Subd. & Lots		Subd. & Lots		Subd. & Lots		Total Lots	Avg. Dmd Res. (gpm)	Known Avg. Flows (gpm)		Known Avg. Flows (gpm)		Avg. Dmd Misc. (gpm)	Total Avg. Dmd (gpm)
		Name	Lots	Name	Lots	Name	Lots			Name	Flow	Name	Flow		
349								0	0						0
350								0	0	Wesl. Water Plant	2				2
351								0	0						0
352								0	0						0
353								0	0						0
354								0	0						0
355								0	0						0
356								0	0						0
357		Orange Grove	52					52	14						14
358		Morning side	30	Hollywood	14			44	12					1	13
359		Unknown Subd.	24	Unknown Subd.	24	Unknown Subd.	24	72	19	7-11 Washteria	6			1	26
360								0	0	Housi. Auth. (N Airp.)	28	Airport Elem.	4	1	33
361								0	0						0
								0	0						0
								0	0						0
								0	0						0

WATER RIGHTS AGREEMENT

THE STATE OF TEXAS

PERMANENT WATER SUPPLY AND
DELIVERY CONTRACT

COUNTY OF HIDALGO

This Permanent Water Supply and Delivery Contract is entered into by and between HIDALGO AND CAMERON COUNTIES IRRIGATION DISTRICT NUMBER 9, a water irrigation district operating within Hidalgo and Cameron Counties, Texas, under the laws of the State of Texas and a political subdivision of the State of Texas, hereinafter referred to as "District", and the CITY OF WESLACO, a municipality operating under the laws of the State of Texas, of Hidalgo County, Texas, hereinafter referred to as "City", wherein the District agrees to supply and deliver to the City untreated water from the Rio Grande and City agrees to receive such waters all in accordance with the terms and conditions of this Agreement.

Background Recitals

1. The District had within its boundaries a total area of more than 81,700 acres and less than 82,100 acres lying within Hidalgo and Cameron Counties as of January 1, 1948, and therefore qualified as a district within the meaning of Article 8280-4, Vernon's Annotated Texas Civil Statutes, (hereinafter referred to as "Exclusion Statute") which provides for the exclusion of land within the District's boundaries which is incorporated within or annexed to the city limits of any incorporated city. In the past and pursuant to the Exclusion Statute, the District has excluded lands annexed to the city limits of City and entered into a series of contracts with the City in compliance with the Exclusion Statute, wherein the City has agreed to pay the proportio-

4/9/84

nate part of the existing bonded or other indebtedness of the District applicable to such excluded lands.

2. In the Final Judgment in Cause No. 261 in the Court of Civil Appeals of Corpus Christi, Texas (opinion reported at 443 S.W.2d 728) which became final in 1971, (hereinafter referred to as "Valley Water Suit Judgment") the Court approved a stipulation of the parties litigant affirming a water allocation to the City for delivery by District of 5,240 acre feet of water per annum, measured at the District's diversion point on the Rio Grande, for use by City for municipal purposes, as further evidenced by Certificate of Adjudication No. 23-812 issued by the Texas Water Commission (hereinafter referred to as "TWC") to District.

3. Since the entry of the Valley Water Suit Judgment, the growth in the population of the City and use of water by the City has made it necessary that the City obtain the assurance of additional water supply above and beyond the 5,240 acre feet per annum water allocation mentioned above. By virtue of the fact that the City entered into a series of contracts with the District in accordance with the Exclusion Statue and assumed the bonded or other indebtedness of District relating to such excluded lands and other considerations, the District is willing to enter into this Contract providing for additional water supply for delivery to the City. Since the District has historically delivered untreated water to the City as City's sole source of supply, the parties desire to include in this Contract, a

delivery charge for all waters delivered by the District to the City and the means by which such delivery charges will be altered in the future.

Additional Water Supply Provisions

4. It is agreed that in consideration of the past exclusions of lands by the District which were included within or annexed to the City Limits of City, and the City's agreement to pay the existing bonded or other indebtedness of such excluded lands, the City shall be entitled to call upon additional municipal use waters from the District amounting to an allocation of 1,954.43 acre feet per annum measured at the District's diversion point on the Rio Grande, and the District agrees to supply and deliver such additional water to the City based upon the terms and conditions of this contract. This Contract is subject to City's payment of such existing pro rata indebtedness on such past and future exclusions, and the failure to do so shall be considered a default of this Contract by City.

5. (a) It is agreed that hereafter the amount of additional water supply, upon which the City may call upon the District for supply and delivery, shall be increased based upon the amount of irrigable agricultural acreage contained in urban land hereinafter excluded from the District's boundaries under the terms of the Exclusion Statute and subject to City's agreement to pay and City's payment of the existing pro rata bonded or other indebtedness assessable against such lands in accordance with the Exclusion Statute. The pro rata bonded or other

indebtedness referred to in this Contract is the current indebtedness of the District at this time, the amount of which will be adjusted to the amount owed at the time of such exclusion proceeding in accordance with the Exclusion Statute, and does not include bonded or other capital indebtedness hereafter incurred by the District.

(b) The amount of additional water supply to which the city may be entitled in this regard expressed in acre feet per annum for municipal use, shall be the irrigable agricultural acreage contained in tracts of urban lands subject to exclusion as determined by the District, multiplied by 1.25. This formula provides the equivalent acre-feet of water per annum of municipal use water, measured at the District's diversion point on the Rio Grande, to which the City is entitled with respect to the exclusion of a particular tract of urban land in the future.

(c) The assumption of such District indebtedness by City with respect to the urban land so excluded, shall be evidenced by a contract between the parties, which will set forth the entitlement of City to further municipal use water supply allocation under the terms of this Contract and such contract(s). Such contract(s) shall be considered a supplement to this Contract and be executed by authorized representatives of the parties in suitable form for recordation in the Official Records of Hidalgo County.

(d) It is specially agreed that the 1.25 factor mentioned above is based upon current rules and Regulations of

TJ 2

the TWC and should the TWC, or any successor agency, modify such applicable Rules and Regulations, this provision shall be modified accordingly.

6. The District agrees in this contract to have available and to supply to the City, subject to the terms hereof, up to initial annual water allocation of 5,240 acre feet evidenced in Certificate of Adjudication No. 23-812 mentioned above, plus the additional annual water allocation of 1,954.43 acre feet mentioned in paragraph 4 above, for a total of 7,194.43 acre feet per annum of municipal use water. In addition, from time to time in the future as there are further exclusions of urban land from the District boundaries pursuant to the Exclusion Statute wherein the City agrees, in contracts supplemental hereto, to assume the then-existing amount of pro rata bonded or other indebtedness of the District attributable to such excluded lands, further allocations of water will be made in accordance with the provisions of paragraph 5 of this Contract.

Water Delivery Charges

7. In consideration of the District's agreement to supply and deliver, or have supplied or delivered, Rio Grande untreated water to City for municipal use in serving its citizens and customers with treated water, it is agreed that the City shall pay to the District for all water delivered to City, measured as provided below, initially a water delivery charge of 8.0¢ per 1,000 gallons of water delivered beginning October 1, 1989, adjusted hereafter as provided for in paragraph 8 below.

REGIONAL WATER SUPPLY & WASTEWATER STUDY

FOR THE

CITY OF WESLACO, TEXAS

PART 2 - WASTEWATER

FINAL REPORT

February 1997

**Sigler, Winston, Greenwood & Associates, Inc.
Consulting Engineers
1604 E. Hwy. 83
Weslaco, Texas**

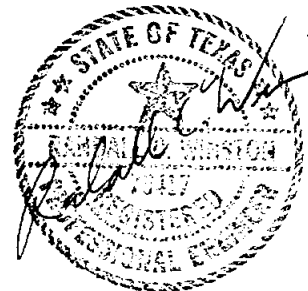

CHAS. A. GREENWOOD, P.E.
PRESIDENT
WM. R. SHEA, P.E.
EXECUTIVE VICE-PRESIDENT

SIGLER, WINSTON, GREENWOOD
& ASSOCIATES, INC.
Consulting Engineers

JOE B. WINSTON, JR., P.E.
SECRETARY
RANDALL C. WINSTON, P.E.
TREASURER

WESLACO, TEXAS 78596-6623 ☐
1604 E. HWY. 83 AC 210-968-2194 FAX 968-8300

MCALLEN, TEXAS 78501 ☐
801 QUINCE ST., SUITE 15 AC 210-682-1326
(REPLY TO OFFICE INDICATED)

March 14, 1997

Re: Regional Water Supply & Wastewater -
Study - Part 2 - Wastewater (Final Report)

Mr. Frank Castellanos
City Manager
City of Weslaco
City Hall
Weslaco, Texas 78596

Dear Mr. Castellanos:

Enclosed please find three (3) copies of the final report of the above mentioned project. Sigler, Winston, Greenwood & Associates, Inc. would like to thank you and your staff for helping us in completing this project.

Yours very truly,

SIGLER, WINSTON, GREENWOOD
& ASSOCIATES, INC.



William R. Shea, P.E.

WRS:tz
Enlc.

✓cc: Mr. Gary Laneman, P.E., Texas Water Development Board, 1700 N. Congress Ave.,
Austin, Texas, 78711-3231

CHAS. A. GREENWOOD, P.E.
PRESIDENT
WM. R. SHEA, P.E.
EXECUTIVE VICE-PRESIDENT

**SIGLER, WINSTON, GREENWOOD
& ASSOCIATES, INC.**
Consulting Engineers

JOE B. WINSTON, JR., P.E.
SECRETARY
RANDALL C. WINSTON, P.E.
TREASURER

WESLACO, TEXAS 78596-6623 ☐
1604 E. HWY. 83 AC 210-968-2194 FAX 968-8300

MCALLEN, TEXAS 78501 ☐
801 QUINCE ST., SUITE 15 AC 210-682-1326
(REPLY TO OFFICE INDICATED)

March 14, 1997

Mr. Gary Laneman, P.E.
Texas Water Development Board
1700 N. Congress Ave.
Austin, Texas 78711-3231

**Re: Regional Water Supply and Wastewater Study - Final Report (Part 2 - Wastewater)
City of Weslaco, Texas**

Dear Mr. Laneman:

On February 19, 1997, we received TWDB's comments on the Draft Final Report. As required by TWDB, enclosed please find nine (9) bound copies and one (1) unbound camera-ready original of the Final Report. The Final Report incorporates TWDB's and City of Weslaco's comments. The Draft Final Report has been revised as follows:

1. Our firm used "High Series Population Projections" (TWDB's 1989 population projections) in the Draft Report. The letter shows that the TWDB released an updated version of the water plan in 1995 (A 1996 Consensus-Based Update to the Texas Water Plan). Also, the letter suggests that we use updated population projections for the future system analyses and recommendations. Accordingly, the wastewater treatment plant capacity, for future conditions, was assessed based on the Most Likely Series Population Forecast.
2. Also, as shown in Part I (Water) of the final report, we used a system-wide water demand of 150 gpcd (with conservation). Based on the water demand, and assuming wastewater generation to be in the range of 65% to 70% of the water demand, we used an estimate of 100 gpcd of system-wide wastewater generation.
3. The letter asks for an explanation on how the cost estimates were developed. Please note that in Chapter 3, Page 3-1, we stated that the cost estimates were based on the most recent bid tabulations of Weslaco's water and sewer projects and by consulting other sources such as local contractors and manufacturers' budget prices.

Thank you. If you have any questions, please call us at (210) 968-2194.

Sincerely,

Sigler, Winston, Greenwood & Associates

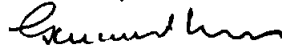

Krishna M. Gobburu, E.I.T.

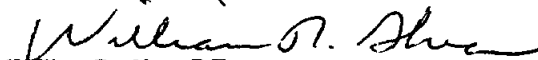
William R. Shea, P.E.

cc: Frank Castellanos, City Manager

**CITY OF WESLACO
WATER & WASTEWATER STUDY**

PART II - WASTEWATER

TABLE OF CONTENTS

1.0 INTRODUCTION

1. General	1-1
2. Need for the Water Study	1-1
3. Scope of the Study	1-1
4. Financial Assistance	1-1
5. Background	1-2
(A) Study Area	1-2
(B) Topography	1-2
(C) Weslaco Population Projections	1-2
(D) Impact Fee Background	1-2
6. Land Use	1-3
(A) Current	1-3
(B) Future (Year 2010)	1-3
7. Study Approach	1-4

2.0 PRELIMINARY ENGINEERING

1. Service Area	2-1
2. Population Projections	2-1
3. EDAP Project Background	2-4
4. Per Capita Wastewater Generation	2-4
5. Collection System	2-5
6. Wastewater Treatment	2-6
7. Odor Problems	2-8
8. Proposed Improvements	2-9
(A) Collection System	2-9
(B) Odor Control	2-9
(C) Wastewater Treatment Plant Improvements	2-10
(D) List Stations Rehabilitation	2-12
(E) Miscellaneous	2-13

3.0 COST ESTIMATION OF THE IMPROVEMENTS

1. Preliminary Cost Estimate	3-1
------------------------------	-----

4.0 PROJECT SCHEDULE & IMPLEMENTATION PLAN

1. Implementation Plan	4-1
(A) Five Year Schedule of System Improvements	4-1
(B) Potential Funding Sources	4-1
a) State Support (If eligible)	4-1
b) Local Funding	4-2
c) User Fees	4-2
5.0 CONCLUSIONS	5-1

Appendices

- Wastewater Discharge Permit
 - Ordinance 96-03
 - A 1996 Consensus-Based Update to the Texas Water Plan - City of Weslaco Population Projections
 - TWDB's Comments on the Draft Final Report
-
-

List of Tables

- 2.1 - Historic and Projected Population Growth for the City of Weslaco
 - 2.2 - Wastewater Flows
 - 2.3 - Inventory of Lift Stations
 - 2.4 - Hydrogen Sulfide Concentrations in Collection System & Treatment Plant
 - 2.5 - Rehabilitation of Existing Lift Stations

 - 3.1 - Cost Summary of Proposed Improvements
 - 3.2 - 3.5 Wastewater Collection System Proposed Improvements
 - 3.6 - Cost Estimate for Rehabilitation of Existing Lift Stations

 - 4.1 - Priority Schedule of the Proposed Improvements
-
-

List of Figures

- 1.1 - Map of Project Study Limits
 - 1.2 - U.S.G.S. Contour Map
 - 1.3 - City of Weslaco Population, 1930-2010
 - 1.4 - Planned 2010 Land Use

 - 2.1 - CCN Map
 - 2.2 - Diversion Areas - Wastewater Flows
 - 2.3 - Weslaco Wastewater Treatment Plant and Surrounding Areas
 - 2.4 - Wastewater Treatment Plant Process Flow Chart
 - 2.5 - Hydrogen Sulfide Toxicity Spectrum
 - 2.6 - Wastewater System - Existing System and Proposed Improvements
 - 2.7 - Inflow Rate - Lift Station No. 3
 - 2.8 - Inflow Rate - Lift Station No. 5
 - 2.9 - Inflow Rate - Lift Station No. 10
 - 2.10 - Inflow Rate - Lift Station No. 12
 - 2.11 - Evaluation of Wastewater Treatment Plants Capacity
 - 2.12 - Proposed Modifications to the Trickling Filter Units to Meet Effluent Discharge Limits
-

CHAPTER 1
INTRODUCTION

1. General

The City of Weslaco, Texas, is a rapidly expanding area of Hidalgo County. Weslaco is located in the Rio Grande valley. The City enjoys hot and long summers and short winters, and like other Cities in the valley attracts a significant number of winter Texans. It is estimated that about 5,000 winter Texans make Weslaco as their temporary home town during the months of December thru March. State Highway 83 runs through the heart of Weslaco. Due to this and also due to the arrival of NAFTA, the City recently attracted many commercial establishments. Proximity to US-Mexican border also contributed for the City's growth in the past and will contribute to the growth in future.

2. Need for the Study

The rapid growth of the City raises many concerns, especially about the capacity of the City's existing facilities such as water, wastewater, and drainage. Although, drainage issues were addressed previously, to a certain extent, by the drainage master plan, there are no significant studies conducted to determine the capacity of the existing water and wastewater facilities both for present and future developed conditions. Therefore it was determined by the City of Weslaco, that an Engineering Study be conducted on the water and wastewater systems that currently serve the City.

3. Scope of the Study

In 1994, the City hired Sigler, Winston, Greenwood & Associates (SWGA) to perform the study. The scope of the study includes evaluation of existing water and wastewater systems for present flows and for flows of year 2010, recommendation of improvements, cost estimation of proposed improvements, and overall conclusions. All these items are discussed in a greater detail in the following chapters.

4. Financial Assistance

This study is sponsored jointly by the Texas Water Development Board (TWDB) and the City of Weslaco. The amounts of funding are as follows:

TWDB	\$ 26,800 (through State Revolving Loan Program (SRF))
City of Weslaco	\$ 26,800 (General revenue and revenue from utility rates)
TOTAL	\$ 53,600

5. Background

A. Study Area

The geographical area encompassed by this planning study includes the City of Weslaco and approximately 15.2 square miles of surrounding territory. The study area extends to Mile 11 N to the north, Mile 7 W to the West, Main Floodway to the South, and Mile 2 ½ W to the East. Figure 1.1 shows limits of the study area.

B. Topography

The topography of the City and surrounding areas is relatively flat with an approximate 1 ft/mile elevation fall to the Northeast. The elevation above MSL varies from 80 feet around South and Southwest to 75 feet around North and Northeast. Figure 1.2 shows the elevation contours of the City and its surrounding areas derived from U.S.G.S. Quad maps.

C. Weslaco Population Projections

A study, "Weslaco Tomorrow", performed by Wilbur Smith Associates in 1990, identifies the historical growth of the City's population. The study also included projected population through year 2010. The growth pattern, both past and future, is shown in the Figure 1.3. This figure was adjusted from current U.S. Census data. Figure 1.3 also includes population projections obtained from TWDB's Water Plan. As it can be seen in the figure, population of Weslaco increased significantly in the last two decades and it is expected to continue in the future. A more detailed discussion on population projections is given in Chapter 2.

D. Impact Fee Background

Impact fee means a charge or assessment imposed by a political subdivision against new development in order to generate revenue for funding or recouping the costs of capital improvements of facility expansions necessitated by and attributable to the new development. Chapter 395 of Texas Municipal Code addresses procedures to be followed in determining impact fees for roadway facilities; water supply, treatment and distribution facilities; wastewater collection and treatment facilities; and storm water, drainage, and flood control facilities. The City may enact or impose an impact fee on land within its boundaries or Extra Territorial Jurisdiction (ETJ) only by complying with Chapter 395. The City may contract to provide capital improvements, except roadway facilities, to an area outside its corporate boundaries and ETJ and may charge an impact fee under the contract, but as noted, if an impact fee is charged in that area, the City must comply with Chapter 395.

It should be noted that the impact fee may only be applied to "New Development." Cost necessary to improve or upgrade existing facilities to serve existing needs are not eligible under Chapter 395.

An impact fee may be imposed only to pay the costs of constructing capital improvements or facility

MAP OF PROJECT STUDY LIMITS

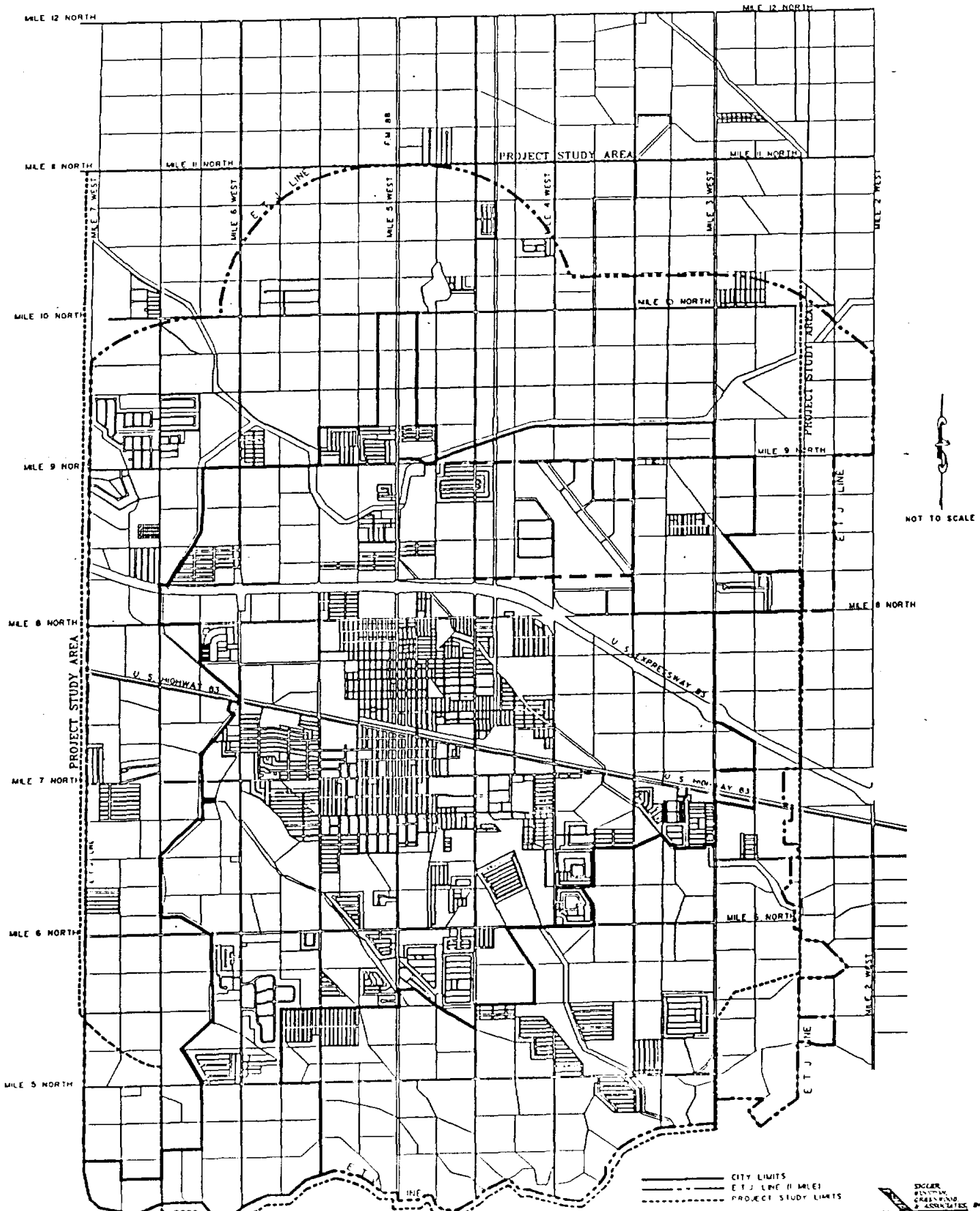

CITY OF WESLACO, TEXAS
 WATER AND WASTEWATER STUDY
 FIGURE 1.1



CITY OF WESLACO POPULATION 1930 TO 2010

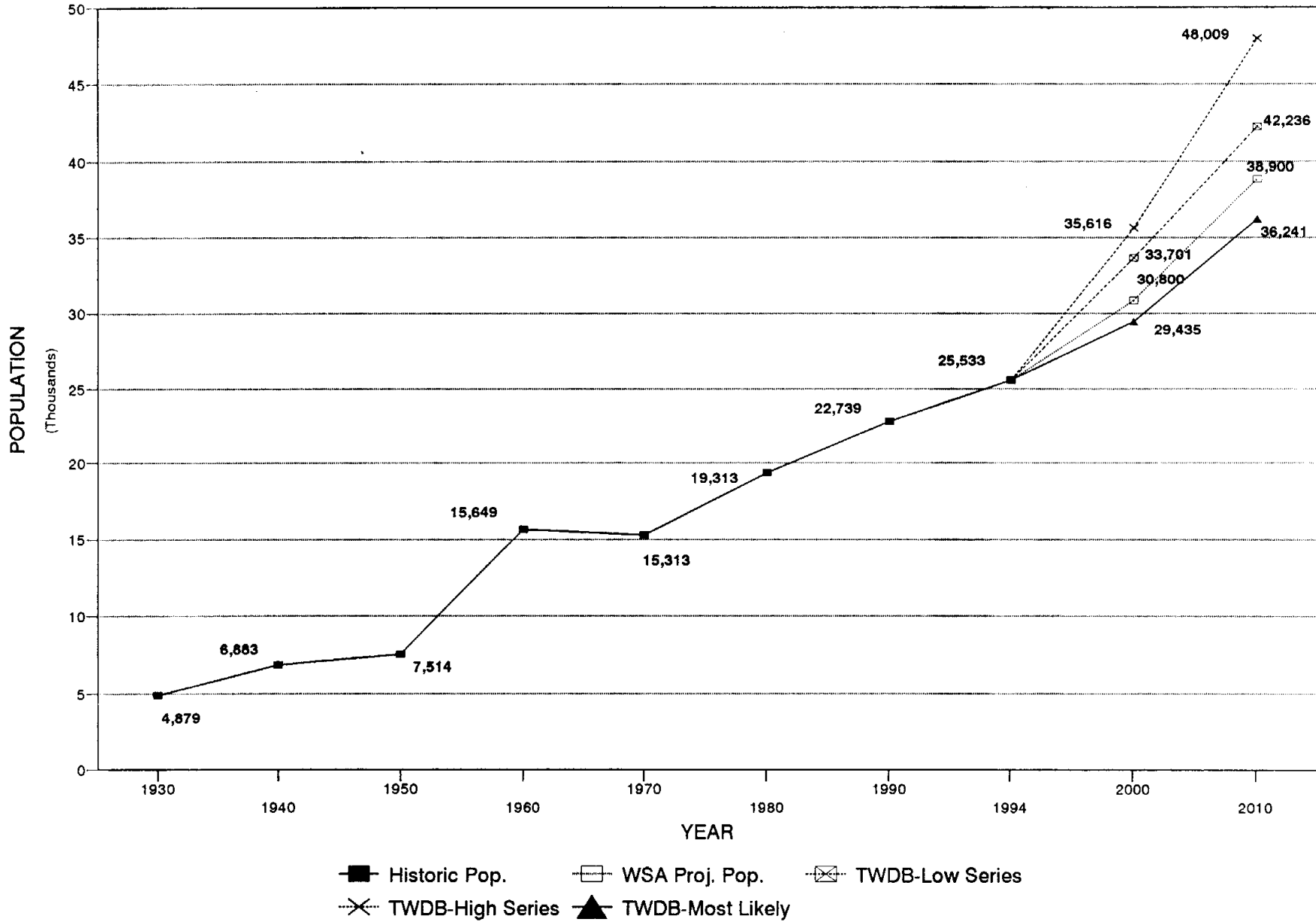

Source: "Weslaco Tomorrow", a study by Wilbur Smith Associates(WSA); City of Weslaco EDAP Report; TWDB Water Plan

FIGURE 1.3

expansions, including and limited to the:

1. construction contract price
2. surveying and engineering fees
3. land acquisition costs, including land purchases, court awards and costs, attorney's fees, and expert witness fees; and
4. fees actually paid or contracted to be paid to an independent qualified engineer or financial consultant preparing or updating the capital improvements plan who is not an employee of the political subdivision.

The City of Weslaco may choose to collect impact fee for the proposed improvements that are discussed in this report. The costs for proposed improvements can be recouped by imposing impact fee to the new developments in the City. The impact fee per service unit may not exceed the amount determined by dividing the cost of the capital improvements by the total number of project service units. If the number of new service units projected over a reasonable period of time is less than the total number of new service units shown by the approved land use assumptions at full development of the service area, the maximum impact fee per service area unit shall be calculated dividing the costs of the part of the capital improvements necessitated by and attributable to project new service units by the projected new service units.

6. Land Use

A. Current

The existing land use of the City of Weslaco can be seen in Figure 1.1. The residential growth is concentrated in South and North of the city and commercial and industrial developments exist along the Expressway 83, and U.S. Highway 83. A major part of the Northeast sector of the city is covered by farmlands. According to the study performed by Wilbur Smith Associates, Weslaco's park system consists of a few larger parks as opposed to several smaller parks. The study also identifies that there is currently a deficit of approximately 70 acres of parkland in Weslaco.

B. Future (Year 2010)

The study performed by Wilbur Smith Associates in 1990 is used for identifying the future land use of the City. According to the report, the majority of the residential growth is expected to occur in the South, Southeast and North areas of the City and its ETJ. Commercial growth will be concentrated in along U.S. HWY 83 and along FM 1015. Future industrial growth should occur in the vicinity of the Mid-Valley Airport and Industrial Park, which is part of Foreign Trade Zone 156. Development of additional parks and recreation areas should accompany future residential growth, particularly in the North, South and Southeast areas of the City and its ETJ. A map showing the

future land use, for the year 2010, is included in this report as Figure 1.4.

7. Study Approach

A two-part approach is used in the Study. Part One identifies City's water facility needs for both current and future conditions (yr. 2010) and Part Two identifies City's wastewater facility needs for current and future conditions. As mentioned earlier, future land use projections were derived from "Weslaco Tomorrow Plan".

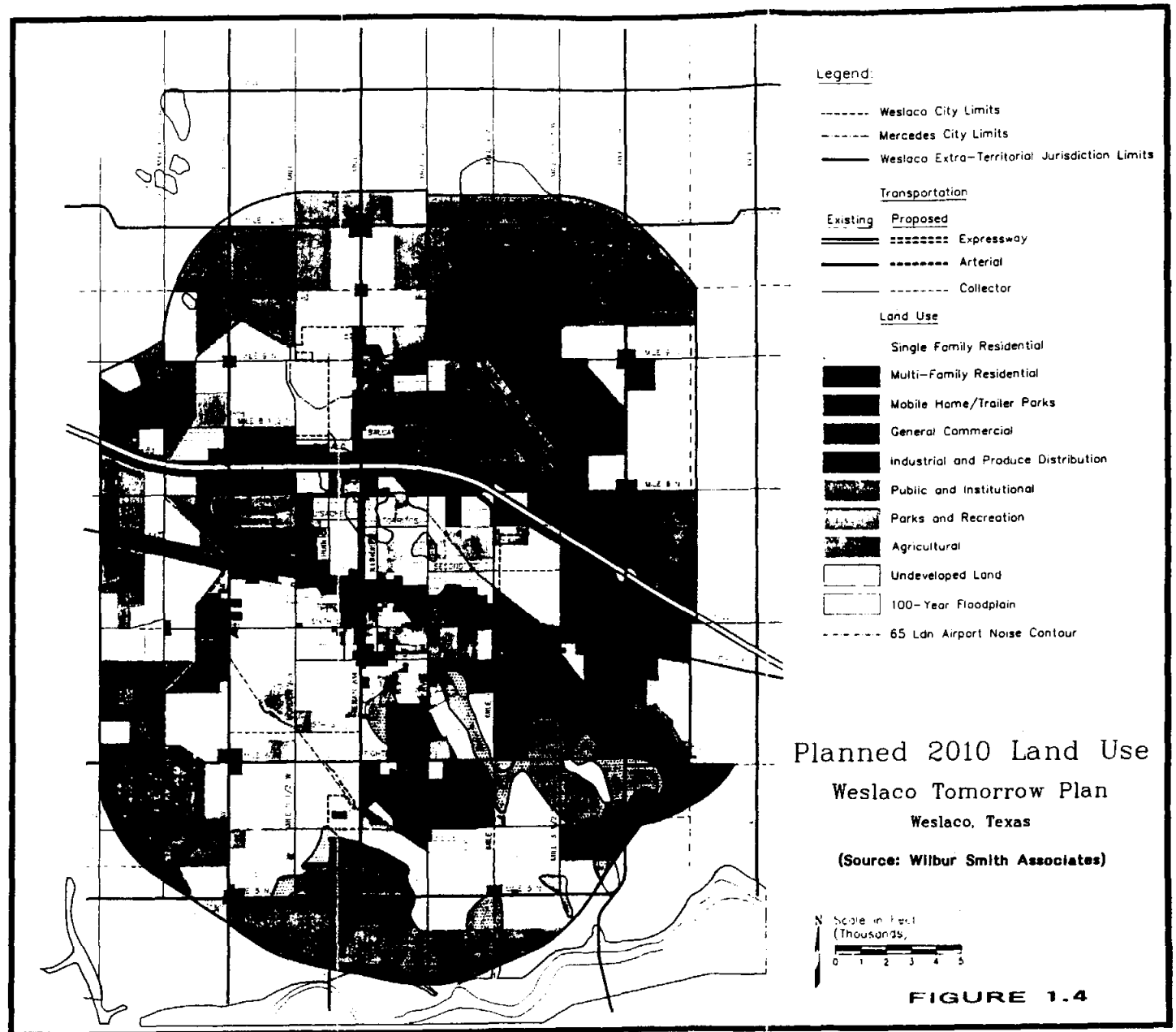

CHAPTER 2

PRELIMINARY ENGINEERING

1. Service Area

The City is authorized by the Texas Natural Resources Conservation Commission (TNRCC) to provide wastewater service to a majority of the project study area (PSA). The City's wastewater CCN (No. 20198) currently extends up to Mile 12 N on the North side, Mile 2 ½ West on the East side, Mile 7 West on the West side, and up to the floodway on the South side. Figure 2.1 illustrates the approximate CCN boundaries of the City of Weslaco.

2. Population Projections

Successful long range water and wastewater planning is dependent on selection of appropriate population forecasting methods. For the purposes of this study, three previously published population studies were evaluated for appropriateness. These studies included:

- Population projections presented by Wilbur Smith Associates in the report entitled *Weslaco Tomorrow - City of Weslaco Comprehensive Plan* dated November 1990, based on US Department of Commerce, Bureau of Census projections;
- Texas Water Development Board Planning Division high series population projections developed for the 1992 Update of the Texas Water Plan, based on 1990 Census performed by the US Department of Commerce; and
- Texas Water Development Board Planning Division high series population projections developed for the TWDB's 1990 Texas Water Plan.
- Texas Water Development Board Planning Division - A 1996 Update to the Texas Water Plan. (In February 1997, the TWDB suggested that we use the updated population projections from the State Water Plan of 1996 in developing our final report.)

Each of the population forecasts are described briefly below.

Wilbur Smith Associates

In September 1990, Wilbur Smith Associates (WSA) of Houston, Texas, was contracted by the City to prepare the *Weslaco Tomorrow - City of Weslaco Comprehensive Plan*. The *Weslaco Tomorrow* study "...is a 20-year Comprehensive Plan that provides the goals, objectives, and policies needed to guide the growth within the City of Weslaco and its extraterritorial jurisdiction." As part of *Weslaco Tomorrow*, WSA conducted a comprehensive review of historical population growth and development trends in the Weslaco vicinity. The period of record evaluated by WSA began in 1930 when the City had a reported population of 4,879 persons. By 1960, when the In-City population was estimated to be 15,649 persons, the City had experienced an average annual growth rate of 3.96 percent. During the 1960s, the City experienced an overall population decrease of approximately 2.1 percent resulting in an annual growth rate of -0.22 percent. For the period 1970 to 1980, the City experienced a 2.36 percent average annual growth rate. The 1990 estimated population for the City

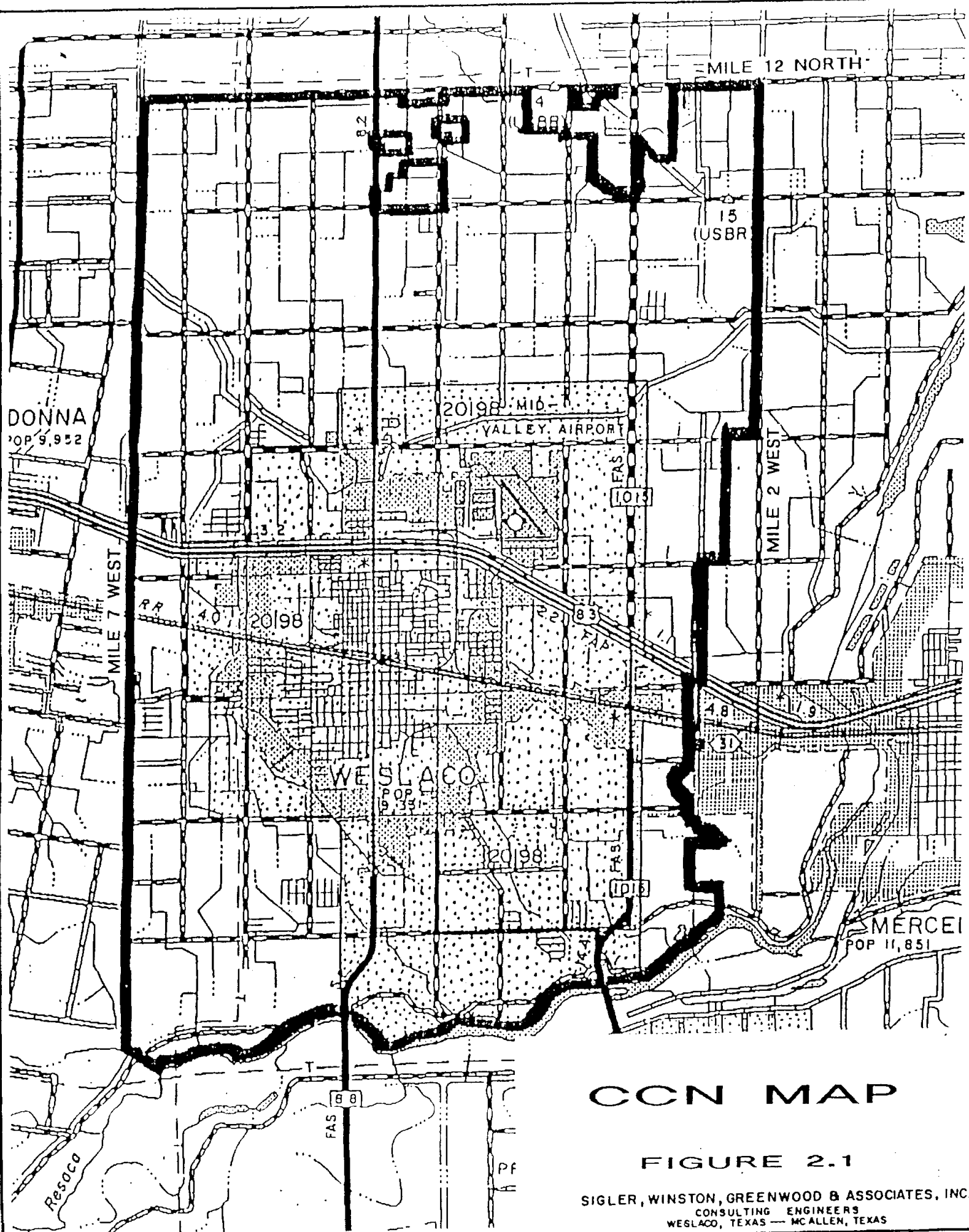

CCN MAP

FIGURE 2.1

SIGLER, WINSTON, GREENWOOD & ASSOCIATES, INC.
 CONSULTING ENGINEERS
 WESLAKE, TEXAS — MCALLEN, TEXAS

of Weslaco used by WSA was 25,644 persons. The WSA population projections extend to 2010 and were developed based on the 1980 US Department of Census population estimates and the assumption that "...the City of Weslaco and Hidalgo County will continue to experience growth for the next 20 years at the same rate as the decade from 1970 to 1980."

Texas Water Development Board

The Texas Water Development Board (TWDB) is mandated under §16.051 and §16.055 of the Texas Water Code "...to prepare and maintain a comprehensive state water plan as a flexible guide for the orderly development and management of the State's water resources..." Population projections and associated municipal, industrial, and agricultural water use projections are developed as part of the TWDB's water planning process. Population projections developed by the TWDB are generally used for all TWDB funded projects unless sufficient evidence can be produced which indicates alternative population forecasts should be used. The TWDB monitors population and migration trends throughout the state and adjusts their population projections accordingly between censuses. Due to the myriad of uncontrollable variables associated with population forecasting, the TWDB develops low and high series population estimates for major metropolitan areas. The TWDB reviews population estimates developed during the Census for correlation to their own estimates. Problems with the 1980 and 1990 Census have, however, caused the TWDB to be cautious of outright acceptance of the US Census as a benchmark for their population forecasts.

Through the 1980s, the TWDB developed population estimates which were based on revisions of the 1980 Census and ongoing tracking of population growth and migration trends throughout the state. The population projections developed in the 1990 Texas Water Plan (1990 Water Plan) reflected the TWDB's understanding of conditions in Texas during 1980s. When the 1990 Census was published, the TWDB expressed concern with the apparent statewide undercount of approximately 564,500 persons, based on a comparison to the estimates presented in the 1990 Texas Water Plan. Inclusion of these 564,500 persons to the official US Census statewide count yielded a 'statistically-adjusted' statewide population which was consistent with the TWDB high series population estimates for 1990, as presented in the 1990 Water Plan. As stated in the 1992 Update to the Texas Water Plan (1992 Update):

"Due to the uncertainty of the viability of the adopted 1990 Federal Census count, the existing state-federal litigation concerning these important figures, and the extremely close comparability of the Board's 1990 forecasts with the statistically-adjusted Census count, the Board feels comfortable using the 1990 Water Plan population forecasts for facility planning purposes until the next few years of annual Census estimates become available. At this later point, the likely settlement of the current state-federal litigation and the availability of additional annual Census populations should provide a better setting for a more clear assessment of any needed update changes."

In 1995, TWDB released "A 1996 Consensus-Based Update to the Texas Water Plan." The update was developed in conjunction with the Texas Natural Resources Conservation Commission and the Texas Parks and Wildlife Department and includes Weslaco's population and water use forecast through the year 2050. The 1996 Water Plan presents the population and water use projections based

on different scenarios such as migration rates, conservation measures, and rainfall patterns. Based on these scenarios, a "Most Likely Series" was developed and presented in the update.

Table 2.1 summarizes the population projections presented by WSA and the TWDB. Population estimates for 1990 range from 21,877 persons (1992 Water Plan Update) to 26,950 persons (1990 Water Plan). The WSA estimate of In-City 1990 population was 25,644 persons. For the years 2000 and 2010, the WSA and 1992 Water Plan Update High Series figures are roughly equivalent. WSA's projection of 38,900 persons for the year 2010 is only slightly larger than the 1992 Water Plan Update High Series projection of 38,646 persons. The 1990 Water Plan forecast for 2010 is 48,009 persons, or approximately 10,000 persons greater than WSA and the 1992 Water Plan Update. By the year 2010, the 1990 Water Plan High Series projections forecast an In-City population of 48,009 persons (9,353 persons more than the 1992 Water Plan Update projections). For the same year, the Most Likely Series forecast is 36,241 persons (2,405 persons less than the 1992 Water Plan Update Projections).

For the purpose of this study, the most likely series population projections developed by TWDB for the 1996 Texas Water Plan will be used. (It is to be noted that, the high series population projections developed in October 1989 by the TWDB for the 1990 Texas Water Plan was used in the draft final report (submitted earlier) for determining projected water demand and wastewater generation for the City and surrounding areas. The final report is being adjusted based on the most likely series).

Using the TWDB Most Likely Series population estimates, the 1990 population for the City of Weslaco was estimated/found to be approximately 21,877 persons. The 2010 population for the City is projected to be approximately 36,241 persons. The growth rate for the decade 1990 to 2000 is projected to be approximately 3% per year and the growth rate for the decade 2000 to 2010 is projected to be approximately 2%. For the period 1990 to 2010, the City's population is projected to grow by approximately 66% (14,364 persons).

As reported in the WSA study, the City of Weslaco also experiences seasonal population growth resulting from the influx of "Winter Texans". Winter Texans, according to the WSA study, "... are seasonal residents who make their home in the Rio Grande Valley for up to five months per year." Based on estimates developed by the City of Weslaco, approximately 2,500 recreational and mobile home units are located inside the City Limits. The WSA study estimates that the In-City winter Texan population may amount to "...a 16% increase above the year round population." For the purposes of this study, it shall be assumed that the seasonal residents are included in the high series population projections.

It is clear from a review of the population forecasts presented above that a diversity of opinion exists with regard to projected population values. As stated previously, beginning in the year 2000, the 1992 Update to the Texas Water Plan and the Wilbur Smith Associates projections all are within 1,000 persons of each other. In contrast, the 1990 Texas Water Plan Low and High Series population estimates are consistently much higher than any of other projections presented. In order to reconcile this disparity in consensus regarding In-City population growth projections, the

Table 2.1

Historical and Projected Population Growth for the
City of Weslaco

	Historical Population / Population Projections							
	1980	1985	1990	1995	2000	2005	2010	2015
Historical Population	19,331	23,837	-	-	-	-	-	-
TWDB 1990 Texas Water Plan Low Series Population Estimates			26,418	29,831	33,701	37,722	42,236	47,276
TWDB 1990 Texas Water Plan High Series Population Estimates			26,950	30,985	35,616	41,349	48,009	55,656
TWDB 1992 Update to 1990 Texas Water Plan Low Series Population Estimate			21,877	25,374	29,433	33,382	37,871	42,410
TWDB 1992 Update to 1990 Texas Water Plan High Series Population Estimate			21,877	25,460	29,623	33,827	38,646	43,917
TWDB 1996 Consensus-Based Update to the Tx. Water Plan - Most Likely Series			21,877		29,435	-	36,241	-
Weslaco Tomorrow (Wilbur Smith Associates, Nov. 1990)			25,644	28,105	30,800	34,610	38,900	-

**Table 2.2
Wastewater Flows
City of Weslaco**

Month	1990			1991			1992			1993			1994			1995		
	Total	Max. Day	Min. Day	Total	Max. Day	Min. Day	Total	Max. Day	Min. Day	Total	Max. Day	Min. Day	Total	Max. Day	Min. Day	Total	Max. Day	Min. Day
Jan.	117.40	8.00	2.20	78.80	4.70	1.60	24.40	1.90	0.00	76.50	7.70	0.30	155.40	5.70	4.20			
Feb.	83.90	5.60	2.10	69.90	6.20	1.00	18.30	0.90	0.40	30.20	2.70	0.30						
Mar.	86.90	3.10	2.60	69.20	4.20	1.00	15.40	0.80	0.30	32.00	3.70	0.20						
Apr.	71.90	3.50	1.40	165.70	13.80	1.00	50.40	5.40	0.00	56.20	4.60	0.10						
May	65.70	2.70	1.40	168.00	9.60	2.40	133.50	6.40	2.00	65.40	3.00	1.50						
Jun.	70.90	3.20	1.30	100.00	4.80	2.10	125.20	6.60	0.00	120.10	7.20	2.00						
Jul.	72.20	2.60	2.10	90.00	5.10	1.60	120.70	6.40	1.30	105.20	5.20	1.70						
Aug.	72.70	2.80	1.30	44.40	3.90	0.50	119.80	6.00	1.50	78.50	4.60	0.20						
Sep.	68.90	3.00	1.50	40.60	3.40	1.00	75.80	6.00	0.00	60.60	3.20	0.60						
Oct.	91.40	8.40	1.80	48.30	4.80	0.40	9.70	4.00	0.00	98.40	6.80	1.60						
Nov.	125.30	10.80	1.40	39.90	2.40	0.90	104.70	5.40	1.90	116.00	5.10	1.30						
Dec.	111.40	19.00	2.10	36.50	2.90	0.00	71.30	5.50	0.40	121.20	5.70	1.30						
TOTAL	1038.60			951.30			869.20			960.30								
Avg. Day Flow:	2.85 MGD			2.61 MGD			2.38 MGD			2.63 MGD								

Note: Flow data not available for years 1994 and 1995 due to malfunctioning of the flow meter

Engineers recommend using a 15-year planning period (1995 through 2010). Moreover, at this time, land use projections beyond year 2010 are not available and therefore, it is not feasible to estimate the growth pattern and suggest improvements beyond 2010. The year 2010 TWDB 1996 Water Plan Most Likely Series population projection for the City of Weslaco is 36,241 persons. Based on the 1995 In-City population estimate of 25,460 persons, a resultant 42% population growth would be anticipated over the planning period.

3. EDAP Project Background

A Phase I Facility Plan and an Environmental Assessment Report were submitted to TWDB under the Economically Distressed Areas Program. Colonias (rural subdivisions) located in the Southwest and Southeast areas of the City were identified, and wastewater collection and treatment systems proposed under this project. The following is a brief summary of the recommendations presented in the EDAP report.

It was recommended that a 2.5 MGD Wastewater Treatment Plant be constructed in the Southwest area of the City. This treatment plant will serve flows from Southeast and Southwest colonias. Also, it was recommended to divert 1,900 acres of In-City flows to the proposed 2.5 MGD treatment plant. It was estimated that about 1.6 MGD (flow from full build-out of the diverted areas) will be diverted to the proposed plant. The diversion will be achieved at the existing Lift Stations # 3 and # 5 by reversing the pressure mains and connecting to the proposed South side lines. Figure 2.2 shows the areas that will be diverted.

Recently the City awarded Engineering Services Contract to Rust Lichliter Jameson Consulting Engineers (RUST) of Houston, TX. Currently, the design of the new plant and collection system is in progress. It is expected that the design will be complete by mid 1997 and the new plant, along with the collection system improvements, will be in operation by June 1998.

In January 1997, due to the budgetary constraints, the City proposed to reduce the EDAP-proposed 2.5 MGD plant to 1.25 MGD. Also, the sizes of some of the EDAP-proposed collector lines, lift stations, and pressure mains were reduced. The design is currently being modified by RUST and it is expected that the design and construction schedule remain the same as shown above.

4. Per Capita Wastewater Generation

In order to be consistent with the water use evaluation, City wastewater treatment plant records were obtained for the period January 1990 through December 1995 to determine a basis for establishing a design wastewater flow rate for the City and surrounding areas. Table 2.2 summarizes monthly self-reporting data for the period of record. Due to the malfunctioning of the flow meter at the headworks of the wastewater plant, accurate flow data was not available for the years 1994 and 1995. Moreover, flow data reported for some of the months during 1992 and 1993 were also found to be inaccurate. Therefore, an average wastewater flow rate for this period January 1990 through 1995 could not be determined. However, the EDAP report estimated 85 gpcd (residential) of the in-city

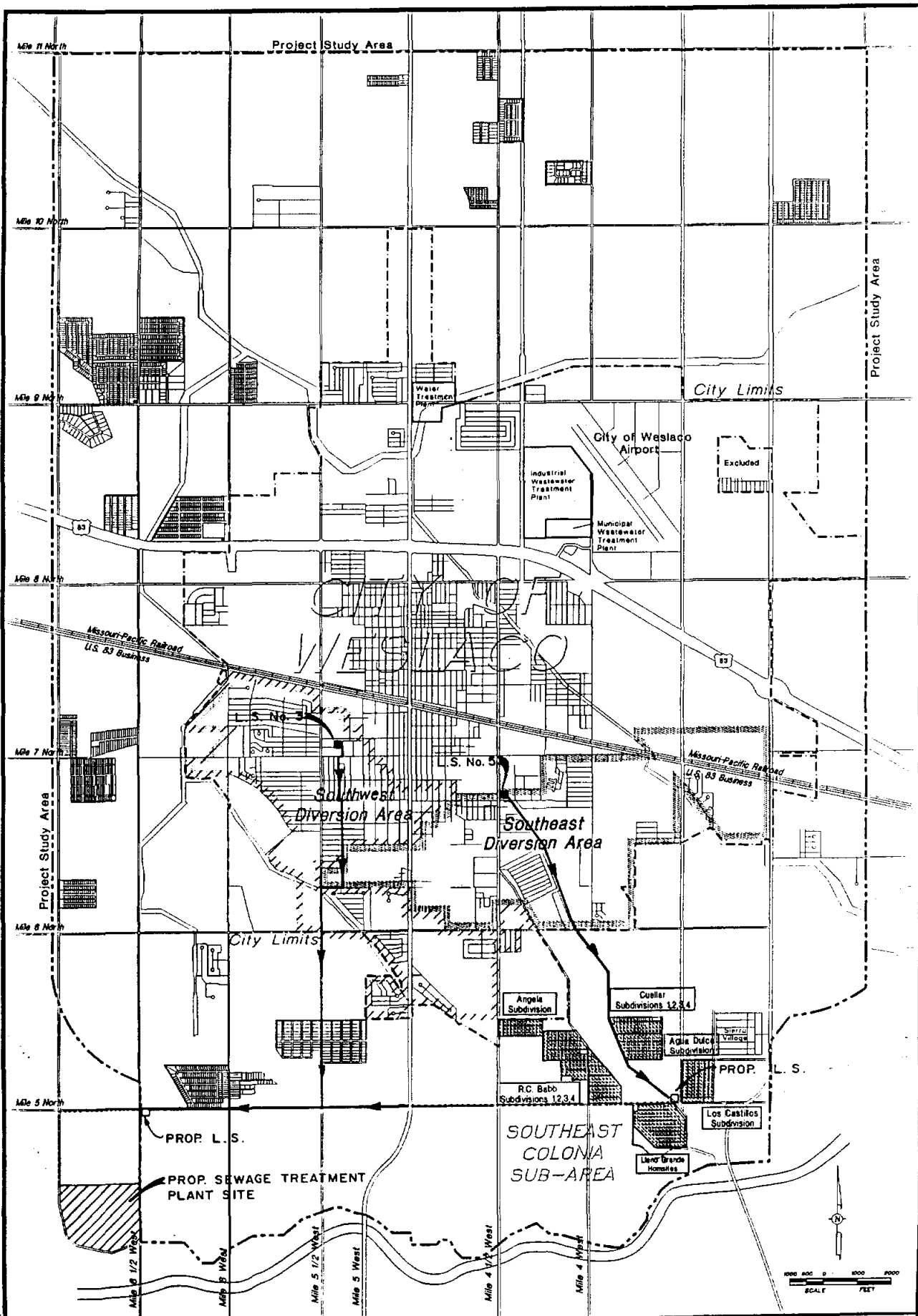

flows (from October 1990 to September 1991). This figure will be used for estimating the wastewater generation (residential) for the City of Weslaco. A system-wide wastewater flow generation is assumed to be in the range of 65 to 70 percent of the system-wide water demand. Thus, considering 150 gpcd of average water demand (as shown in Part 1 - Water), the system-wide wastewater generation will be in the range of 97 to 105 gpcd. For the treatment plant capacity evaluation, about 100 gpcd of system-wide wastewater generation will be used.

5. Collection System

The City's collection system consists of gravity lines of sizes from 6 inches to 27 inches in diameter, 30 lift stations, and pressure mains of various sizes. Data from various sources was gathered and compiled, to the best possible extent, and a system map prepared for the report. However, there might be still some lines on which no information is available at this time. Some of the lines were either field verified or gathered from the City's utilities department. Table 2.3 is a list of the existing lift stations. (We could gather details on flows, pumps, etc. on only a few lift stations at this point. Presently, different sources are being consulted to gather and compile information on remaining lift stations. Table 2.3 needs to be updated as and when the information becomes available.)

The relatively flat topography of the Weslaco area, coupled with a development pattern which includes several isolated outlying developed areas, has resulted in a collection system which includes numerous lift stations and force mains, as well as probable periodic surcharging of gravity sewers. 30 lift stations are now included in the Weslaco collection system, with one more proposed or under construction. Over the years, these lift stations have undergone modifications and rehabilitation due to changing capacity requirements or to address deterioration of facilities. At present, a majority of the existing lift stations need rehabilitation due to deterioration of buildings, pumps, and other accessories.

Additional lift stations and force mains have recently been added to the City's collection system, in order to allow extension of service to the colonias (under EDAP project). It is anticipated that similar future extensions of the City's wastewater area will result in even more lift stations and long force mains ultimately being added to the Weslaco system.

The presence of large numbers of lift stations in the collection system may serve to provide some attenuation of peak flow rates within the collection system. This effect, coupled with relatively low inflow as a result of limited average annual rainfall, may result in a reduced ratio of peak flow to average daily flow rates at the wastewater treatment plant, as compared to what would normally be expected for a facility with a service area of comparable size.

An Infiltration/Inflow (I/I) was performed in 1981 by Garcia and Wright Consulting Engineers of San Antonio, Texas. The report concluded that there was no excessive infiltration/inflow in the sanitary sewer system. It is assumed, at this point, that the conclusion made in 1981 is still valid and therefore no further evaluation is performed to check the infiltration/inflow of the sanitary sewer system of the City of Weslaco.

Table 2.3

INVENTORY OF LIFT STATIONS

L.S. NO.	LOCATION	WET WELL SIZE	W WELL INV. EL. (FEET)	INFLOW PIPE EL. (FEET)	DISCH. PIPE EL. (FEET)	NO. OF PUMPS		PUMP STAGING						PUMPS CAPACITY (GPM)	
						OPER.	STAND BY	# 1 ON	# 1 OFF	# 2 ON	# 2 OFF	# 3 ON	# 3 OFF		
1	First & Garza														
2	Texas & Agostadero														
3	Tula & Stone	21'X7'X22' (deep)	56.36	63.20	72.70	2									
4	Oregon & Hwy. 83														
5	S. Bridge St.	21'X7'X23' (deep)	53.16	58.67	70.50	2									
6	Pat Cannon St.														
7	Back of Sewer Plant														
8	Mile 10 N														
9	Plaza & Iowa														
10	Torritos & Illinios	24'X7'X17' (deep)	56.40	61.40	68.40	2									
11	Utah St. (El Tejano LS)	14'X6'X17' (deep)	59.00	63.00	71.00	2				64.50	61.50				
12	3W & Joe Stephen														
13	Leisure World Park Mobile														
14	Mile 6 West														
15	McManus Produce														
16	Mile 3 S/ Siesta Vill														
17	Mile 4W & 18th Street														
18	Mile 9N & 4 1/2 West														
19	Tejas Subdivision														
20	S. Tx. & Hidden Valley														
21	Mile 3W & Palm Aire Motel	6' dia. 21' deep	48.00	53.00	66.00	2		52.00	50.00	53.00	50.00				
22	Sherry Barbee & Hwy. 83														
23	De Los Santos St. (Diana Subd.)	6' dia. 17' deep	52.82	58.32	66.50	2		55.32	53.82	58.32	53.82				
24	Dickens														
25	Center Point														
26	1015 & Mile 9														
27	1015 & Trailer Park														
28	M 3 1/2 W and M 9 N	6' dia. 16' deep	49.40	53.50	61.80	2		52.90	50.90	53.90	50.90				
29	Cleckler Heald School	18'X9'X16' (deep)	61.50	65.50	73.50	2		64.00	63.00	65.00	63.00				
30	18th St. & Border														

Detailed information on all the list stations is not available at this point. This table needs to be updated as and when the information becomes available.

6. Wastewater Treatment

The City operates two wastewater treatment facilities - an industrial facility and a municipal facility. Industrial wastes are collected in a separate collection system and are discharged to an independent industrial treatment lagoon system and will not be discussed further in this study. Domestic wastewater is collected and discharged to the City's municipal wastewater treatment facility located immediately adjacent to the west side of Mid Valley Airport in north central Weslaco. This treatment plant will be referred to as the "North" plant throughout the report. Figure 2.3 is an aerial photograph of the City's North side wastewater treatment facilities.

The City's municipal wastewater treatment facility uses the combination of trickling filters and an oxidation ditch to accomplish the required levels of treatment. The City's trickling filter system, rated at 1.00 MGD, was constructed in 1953 for a cost of \$165,458. In 1972, a new sludge digester, with associated sludge drying beds and sludge transfer pumps, was constructed at the municipal plant for a cost of \$192,342. The 2.00 MGD oxidation ditch facility was constructed in 1987 at a cost of \$2,077,967. The City's domestic facility is currently permitted for a 3.00 MGD 30-day average daily discharge (TNRCC Permit No. 10619-102) under Effluent Set 3. Effluent Set 3 limits the BOD₅ discharge to 20 mg/L and the discharge of total suspended solids (TSS) to 20 mg/L. However, starting July 1, 1998, the plant will be subjected to stricter effluent limits, 10/15/3 (BOD/TSS/N-NH₃). The City's municipal wastewater treatment facility discharges to a 30-inch outfall with ultimate discharge to the North Floodway (Stream Segment 2491 of the Nueces-Rio Grande Coastal River Basin). A copy of the wastewater discharge permit is included in the Appendix.

In the treatment systems, the raw wastewater passes through an influent channel with a mechanical bar screen and Parshall Flume. After passing through the bar screen it then flows to the aerated grit chamber which removes gritty materials in the waste. After the grit chamber, one stream of the wastewater flows to the trickling filter plant and another stream flows to the oxidation ditch plant. Thus, the wastewater flow undergoes a pretreatment process including the mechanical bar screen and the aerated grit chamber.

The wastewater then is aerated in the oxidation ditch for biological stabilization. The mixture of the wastewater and sludge is agitated by the mechanical aerating rotors in the aeration basins. The stabilized wastewater is then settle in the final clarifiers. A portion of the sludge from the final clarifiers is wasted to the sludge drying beds and a portion of the sludge is returned to the aeration basins to provide the necessary microorganisms in the aeration basins.

The clarified wastewater flows then to the chlorine contact chamber for disinfection and then is discharged to the North floodway.

The digested sludge from the aerobic sludge digester is then dewatered in the sludge drying beds.

In general, the Weslaco Wastewater Treatment Plant consists of the following major processes.

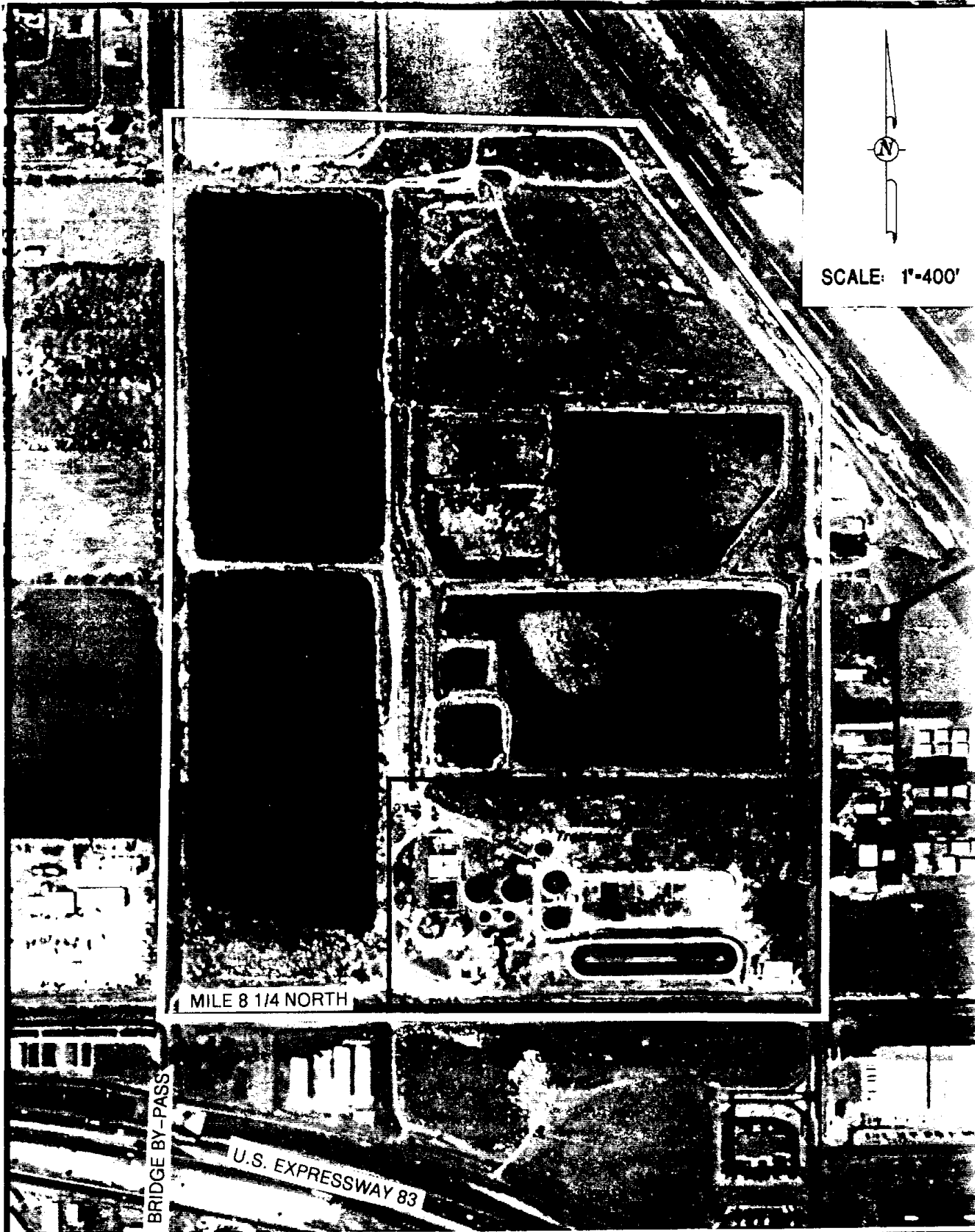

SIGLER, WINSTON
GREENWOOD & ASSOC. INC.

CITY OF WESLACO
REGIONAL WATER SUPPLY &
WASTEWATER STUDY

FIGURE 2.3
Weslaco Wastewater Treatment Plant
and Surrounding Area

Drawn By

Date

1. Pretreatment

- * Mechanical Bar Screen - to remove stringy or sizable matters to prevent clogging or abrasion of mechanical equipment.
- * Parshall Flume - to measure the amount and rate of wastewater through this treatment Plant.
- * Aerated Grit Chamber - to remove gritty materials in the wastewater to enhance the efficiency of biological stabilization.

2. Secondary Treatment

* Trickling Filters

- * Aeration Tanks - the wastewater after pretreatment is biologically stabilized in the aeration basins. The oxygen required for waste stabilization is provided by the aerating rotors.

From here the wastewater flows to the final clarifiers.

3. Clarifiers

- * The final clarifiers provide a quiescent environment necessary for the separation of solids from the wastewater. The solids settle to the bottom and part of them are either returned to aeration tanks for stabilization or wasted to the sludge holding tanks then to the sludge drying beds.

4. Chlorination Facilities

- * The chlorination facilities consists of chlorine contact tank, chlorine containers and three gas chlorinators.

5. Sludge Handling Facilities

- * Waste secondary sludge flows to the drying beds where it is dewatered. Dried sludge must be removed from the beds and hauled away for disposal.

Figure 2.4 is a schematic of the City's Wastewater Treatment Plant process.

As a condition of the City's current wastewater discharge permit, the City was required to meet Final II Effluent Limits by June 1995. In order to comply with these restrictions, especially the N-NH₃ limits, the existing 1.0 MGD trickling filter system was removed from service leaving only 2.00 MGD of usable capacity at the existing facility. As mentioned earlier, in order to comply with the Final II Effluent Limits and provide the treatment capacity necessary to meet current and projected needs,

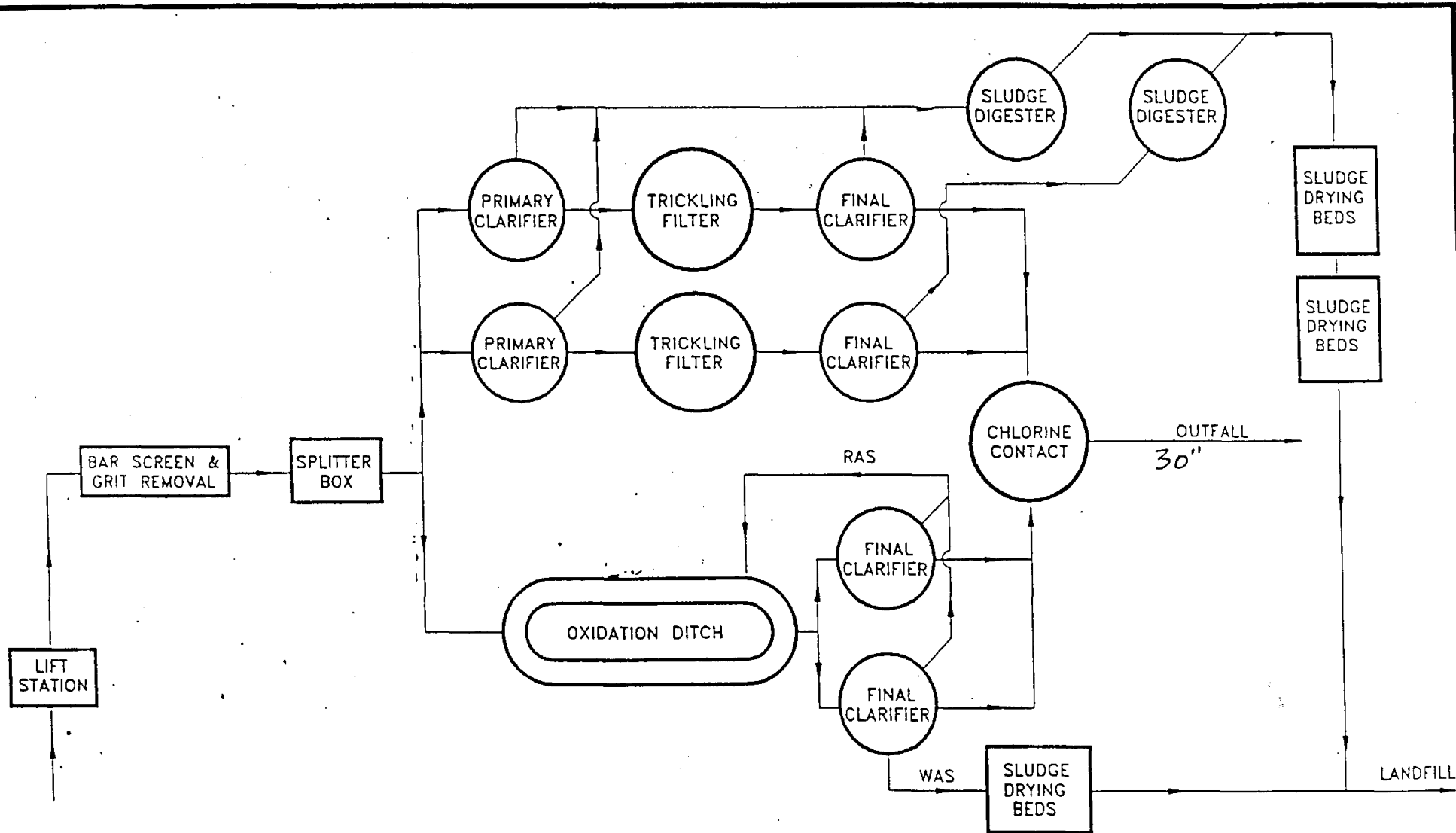

WASTEWATER TREATMENT PLANT
 PROCESS FLOWCHART
 CITY OF WESLACO, TEXAS

< FIGURE 2.4

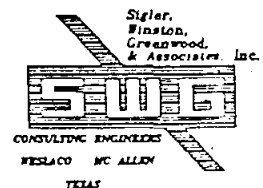

the City is proposing to divert approximately 1.60 MGD of full build-out capacity from the existing facility to a new facility located on the Southwest side of town. The proposed "South side" facility will be sized to provide capacity to serve most of the City south of US Highway 83, in addition to the areas to the southwest and southeast of town. The existing 2.00 MGD extended aeration facility will then have capacity available to serve the immediate future growth north of US Highway 83 in addition to providing potential capacity for the areas located to the west, northwest, and north parts of town. In order to provide additional capacity to the areas north of US Highway 83, the City could potentially utilize the trickling filters as primary treatment units for a future aeration system. This process modification is further discussed in the later sections of this chapter.

7. Odor Problems:

The City of Weslaco's Wastewater Treatment Plant and areas surrounding some of the lift stations are experiencing odor problems. There are many odorous compounds found in sewage such as hydrogen sulfide, ammonia, and mercaptans. Weslaco's main problem is that of hydrogen sulfide.

Hydrogen sulfide gas forms in wastewater collection and treatment systems under anaerobic conditions (no dissolved oxygen or nitrate present). Sulfate normally present in wastewater is biologically converted to sulfide (S_2), hydro sulfide (HS), or hydrogen sulfide (H_2S) in the anaerobic zone within the bacterial slime layer on collection system walls, with increased hydrogen sulfide production occurring at decreasing pH or increasing temperatures.

Hydrogen sulfide constitutes a serious occupational hazard to treatment plant and collection system workers. The gas is potentially explosive in high concentrations, and is highly toxic, with eye and respiratory injury occurring at levels above 50 ppmv (parts per million by volume in air), and life-threatening pulmonary edema resulting from exposure to levels over 300 ppmv.

Hydrogen sulfide is also highly corrosive. Hydrogen sulfide-laden condensate in sewer structures is converted to sulfurous acid and sulfuric acid by bacterial activity. This acid attacks ferrous and concrete structure, resulting in excessively rapid deterioration of concrete pipes and manholes, iron and steel castings, and other metallic appurtenances. Hydrogen sulfide is also the primary source of odor complaints in wastewater facilities, having a strong "rotten-egg" odor detectible at very low concentrations. Figure 2.5 presents the Hydrogen Sulfide Toxicity Spectrum.

Normal air exchange within a partially full gravity sewer generally provides adequate oxygenation to control formation of hydrogen sulfide. The presence of surcharged gravity sewers, inverted siphons, wet wells, or force mains creates a situation in which air exchange is limited, resulting in a reducing chemical environment in which available sulfates are rapidly converted to sulfides. As a result of the numerous wet wells and force mains within the City of Weslaco's collection system, as well as likely surcharging of gravity sewers under diurnal peak flows, the City's collection system is inherently susceptible to formation of hydrogen sulfide gas.

Hydrogen sulfide has been detected in the atmosphere of the existing headworks at the North Plant

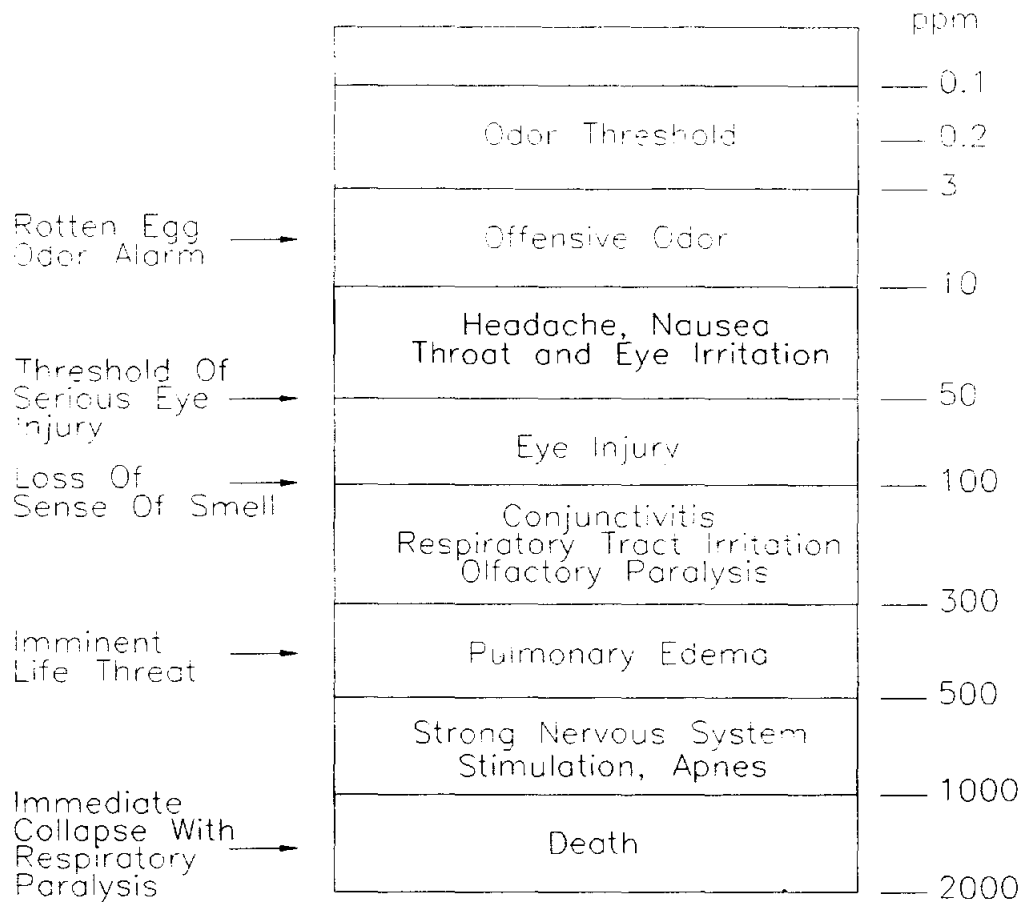

FIGURE 2.5
Hydrogen Sulfide Toxicity Spectrum

Source:
Sanitary Sewerage Systems And Treatment Plants
(EPA/625/1-85/018)

Sigler,
Winston,
Greenwood,
& Associates, Inc.
SWG
CONSULTING ENGINEERS
WESLACO-McALLEN
TEXAS
SINCE 1945

and also in some of the existing lift stations. Field tests were conducted to determine the hydrogen sulfide concentrations. Table 2.4 shows the H₂S concentration in wastewater and ambient air at some of the lift stations and at the plant headworks. The readings were taken on the dates shown in the table. As it can be seen from the table, the H₂S concentration at Lift Station # 10 is very high and exceeds the toxicity threshold limits (see the toxicity spectrum). Lift station # 5 also experiences high concentrations of hydrogen sulfide. It is highly probable that the corrosion due to release of hydrogen sulfide is playing a major role in accelerating deterioration of some of the units at these lift stations as well as the plant head works. Suggestions for odor control are given in the later sections.

8. Proposed Improvements

a) Collection System:

Based on the land use projections for the year 2010, the City's collection system is extended to serve the potential growth areas. Also, the collection system is proposed to serve the existing subdivisions that currently do not have sewer services.

It should be noted that, in most cases, the lines are sized based on the topography and not on the actual anticipated flows. Due to the relatively flat terrain within and surrounding Weslaco, and to reduce the number of lift stations, it was necessary to oversize some of the lines.

It was determined that at least three new lift stations be added to the collection system. The first one should be located at M 4 ½ W and M 10 N to serve existing Mid Valley Estates, Country Aire Estates and other areas in the North. The second lift station is proposed at M 6 ½ W and M 9 N to serve the subdivisions and colonias located at the Northwest of Weslaco. The third lift station is proposed on Milano Drive (M 6 ½ W) and Hwy. 83. The final design of this lift station is complete and the construction is due to commence as soon as the City awards the contract to the lowest bidder. This lift station serves Mid Way Village, Rosedale Heights, La Palma subdivisions as well as other areas in the general vicinity. Figure 2.6 shows the existing and proposed lines.

b) Odor Control

The most readily available and affordable methods of sulfide control at the treatment plant and collection system are prechlorination and aeration of raw influent.

The City's limited budget for wastewater collection and treatment precludes consideration of aeration or chemical addition within the collection system. However, it is suggested that damage to collection system components susceptible to corrosion can be reduced, by implementing the following relatively inexpensive measures:

1. Adjust lift station level controls to minimize retention time in wet wells while flushing the force main (as nearly as possible) exactly once or more (integer) per pump cycle. Lowering of the floats/controls in the lift stations will ensure fresher sewage, less hydrogen sulfide production, and

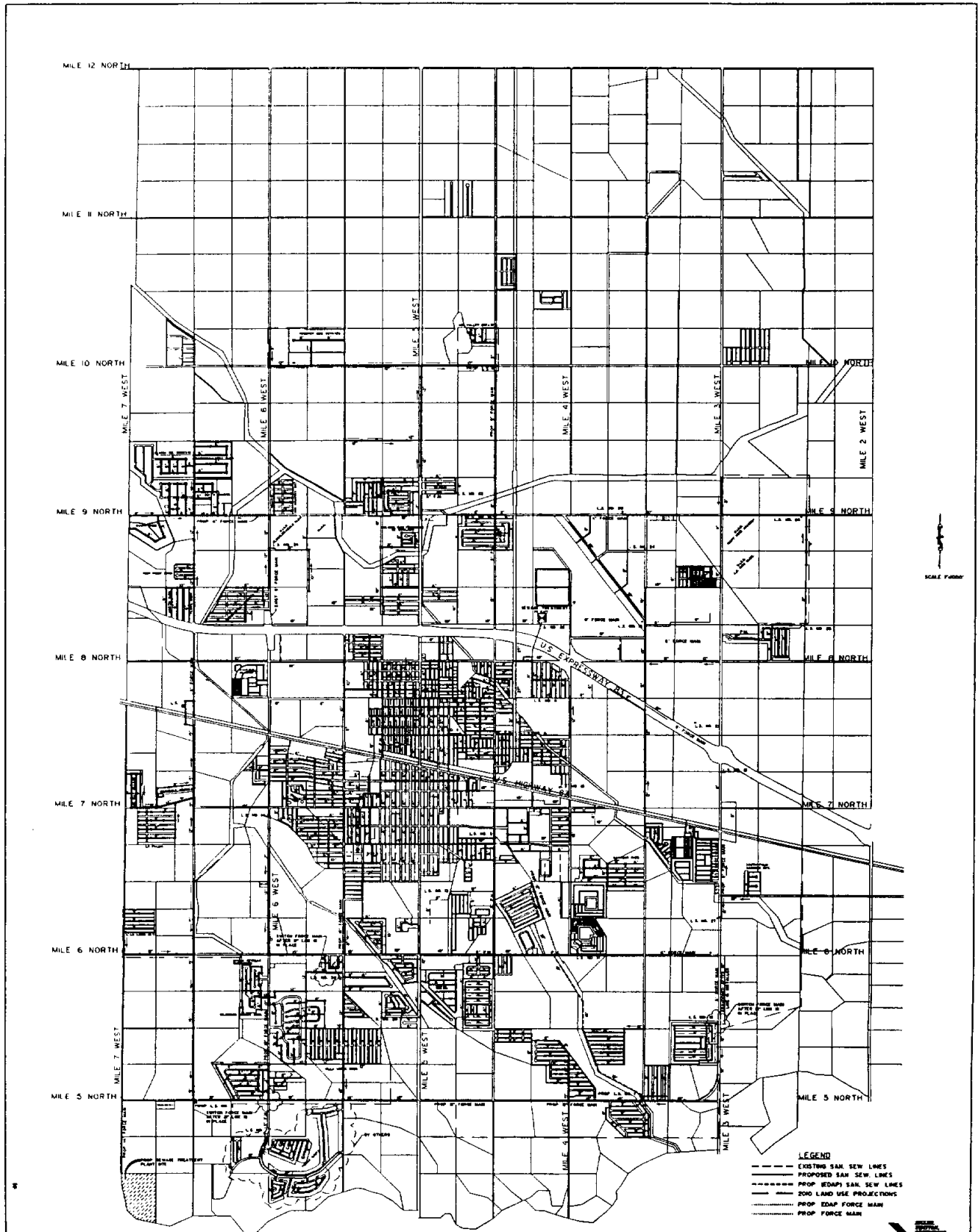

FIGURE 2.6
 CITY OF WESLACO, TEXAS—WASTEWATER SYSTEM
 EXISTING SYSTEM AND PROPOSED IMPROVEMENTS



Table 2.4
Hydrogen Sulfide Concentrations in Collection System & Treatment Plant

Location	Date	Time	H2S in Air (ppm)	H2S in Water (ppm)	Temp. deg. F	pH Std. Units	Remarks
WWTP Headworks - Parshall Flume	04/22/96	09:15 AM	300	55	92	6.9	
	05/08/96	04:15 PM	350	40	92	6.6	
WWTP Headworks - Splitter Box	04/22/96	09:30 AM	600	65	91	6.8	
	05/08/96	04:40 PM	800	35	91	6.8	
	01/11/89	11:05 AM	200	NA	NA	NA	NA - Not Available
Lift Station # 1	05/08/96	03:15 PM	140	15	92	7.3	
	05/16/96	10:15 AM	100	8	89	7.1	
	01/11/89	01:10 AM	0	0	NA	NA	
Lift Station # 3	04/22/96	01:20 PM	45	10	91	6.8	
	05/08/96	11:00 AM	80	20	92	6.9	
	05/08/96	01:00 PM	35	15	90	7.2	
	05/16/96	12:00 PM	20	25	90	7	
	01/11/89	01:25 AM	0	5	NA	NA	
Lift Station # 4	05/08/96	11:40 AM	35	30	90	7	
	05/16/96	12:45 PM	40	10	88	6.9	
Lift Station # 5	04/22/96	10:40 AM	300	30	90	6.9	
	05/08/96	10:30 AM	400	30	91	7	
	05/08/96	01:40 PM	450	40	90	7.1	
	05/16/96	12:30 PM	200	35	92	7.1	
	06/07/96	10:40 AM	450	30	92	7	
	01/11/89	01:35 PM	0	30	NA	NA	
Lift Station # 9	05/16/96	10:00 AM	0	0	90	6.8	
Lift Station # 10	04/22/96	11:35 AM	1200	25	92	7.1	
	05/08/96	10:00 AM	900	25	93	6.8	
	05/08/96	03:35 PM	1050	35	92	6.7	
	05/16/96	11:45 AM	1000	30	93	6.8	
	06/07/96	11:50 AM	1100	35	90	7.1	
	01/11/89	12:55 PM	90	15	NA	NA	
Lift Station # 11	05/16/96	01:10 PM	35	15	91	7	
Lift Station # 12	05/16/96	02:40 PM	225	20	92	6.9	
Lift Station # 16	05/16/96	03:30 PM	45	15	91	7.1	
Lift Station # 20	05/16/96	04:10 PM	25	10	92	6.8	
Manhole at Pueblo & Casa Blanca	06/07/96	08:45 AM	20	45	90	6.1	
Manhole at Pueblo & Esplanda	06/07/96	09:30 AM	5	25	91	6.2	

will also prevent the backing up of sewage in the gravity collectors leading up to the lift station.

2. Modify lift station pumping rates (through impeller upgrades or pump alternations) to produce a velocity of 3.5 to 4.5 feet per second in the force mains at least once daily. This velocity is adequate to minimize the thickness of the slime layer which can form in the force main, reducing overall sulfide production.
3. Clean the sand accumulation in the Los Torritos Lift Station (No. 10), and check all other lift stations for debris.
4. Start and keep a regular maintenance program. An effective maintenance program can minimize operation costs, prevent interruptions in sewer service, and can also minimize the legal responsibility if damage occurs due to sewer stoppages. Such a program might consist of (1) regular inspection, (2) preventive maintenance, and (3) timely repairs.
5. Continue the injection of gaseous chlorine at various lift stations in the collection system. This will oxidize the bacteria found in the raw sewage, and help maintain the freshness of it.

Since high concentration of H₂S was determined in Lift Stations 5 and 10, it is recommended that a permanent odor and corrosion control program be implemented at these lift stations with the injection of BIOXIDE. BIOXIDE is a biochemical process solution, available from DAVIS Process Industries, which controls odor and corrosion caused by hydrogen sulfide and other compounds present in wastewater. BIOXIDE provides for a population of beneficial bacteria which oxidize dissolved hydrogen sulfide and other reduced sulfur compounds. In order to determine the exact dosage of BIOXIDE required, it was necessary to determine the actual amount of flows arriving at lift station # 5 and 10. A flow meter "Station Analyzer" was installed at these lift stations and also at lift stations 3 and 4, and the flow measurements were obtained. The summary report along with the figures (2.7 through 2.10) showing flow pattern are included in the following pages. The required BIOXIDE dosage is calculated by using the following formula:

$(S1 - S2) \text{ of Sulfide removal} \times 8.34 \times 0.7 \text{ gals of Bioxide per 1 lb sulfide} \times \text{flow in MGD}$, where S1 is the initial concentration of H₂S in solution and S2 is the final concentration of the H₂S desired in the solution.

c) Wastewater Treatment Plant Improvements

With the new plant in place, by June 1998, the City should be capable of treating 3.25 MGD of domestic wastewater. (Recall that 1.00 MGD of capacity associated with the existing trickling filter facility was removed in order to meet mandated discharge limitations, resulting in an actual usable capacity of 2.00 MGD at the existing North side plant). In the draft final report that was submitted earlier, it was concluded that with the then proposed 2.5 MGD South side plant, the City should be able to serve the population beyond year 2010. But due to the recent changes in the proposed South side plant (ie., reducing the capacity from 2.5 to 1.25 MGD), and with the inclusion of the TWDB's

Summary Report for Station-Analyzer™

Report Date : 12/2/96	Period : 3 Days
Site : LS_3	Report From : 11/18/96 4:47:00 PM
Description : LIFT STATION 3	Report To : 11/21/96 5:02:00 PM

Flow Information

Total Flow : 625349.40 Gallons
Average Inflow Rate : 144.79 GPM
Minimum Inflow Rate : 45.71 GPM @ 11/19/96 5:49:01 AM
Maximum Inflow Rate : 255.28 GPM @ 11/21/96 9:11:30 AM

Pump Information

<u>Pump #</u>	<u># of Starts</u>	<u>Run Hours</u>	<u>% Usage</u>	<u>Avg. Pump Rate</u>
1	0	0.00	0.00%	0.00 GPM
2	129	25.43	100.00%	411.81 GPM
3	0	0.00	0.00%	0.00 GPM
4	0	0.00	0.00%	0.00 GPM

Average Flow Rate for Pump Combinations

<u>Pumps</u>	<u>Pump Rate</u>	<u>Pumps</u>	<u>Pump Rate</u>	<u>Pumps</u>	<u>Pump Rate</u>	<u>Pumps</u>	<u>Pump Rate</u>
1,2	0.00 GPM	2,3	0.00 GPM	1,2,4	0.00 GPM	2,3,4	0.00 GPM
1,3	0.00 GPM	2,4	0.00 GPM	1,2,3	0.00 GPM	1,2,3,4	0.00 GPM
1,4	0.00 GPM	3,4	0.00 GPM	1,3,4	0.00 GPM		

Station Information

Average Pump Time : 11.83 Minutes
Total # of Cycles : 129
Average Fill Time : 21.65 Minutes

Other Events

INFLOW RATE
Site:LS_3 LIFT STATION 3
Period:11/18/96 4:47:00 PM - 11/21/96 5:02:00 PM

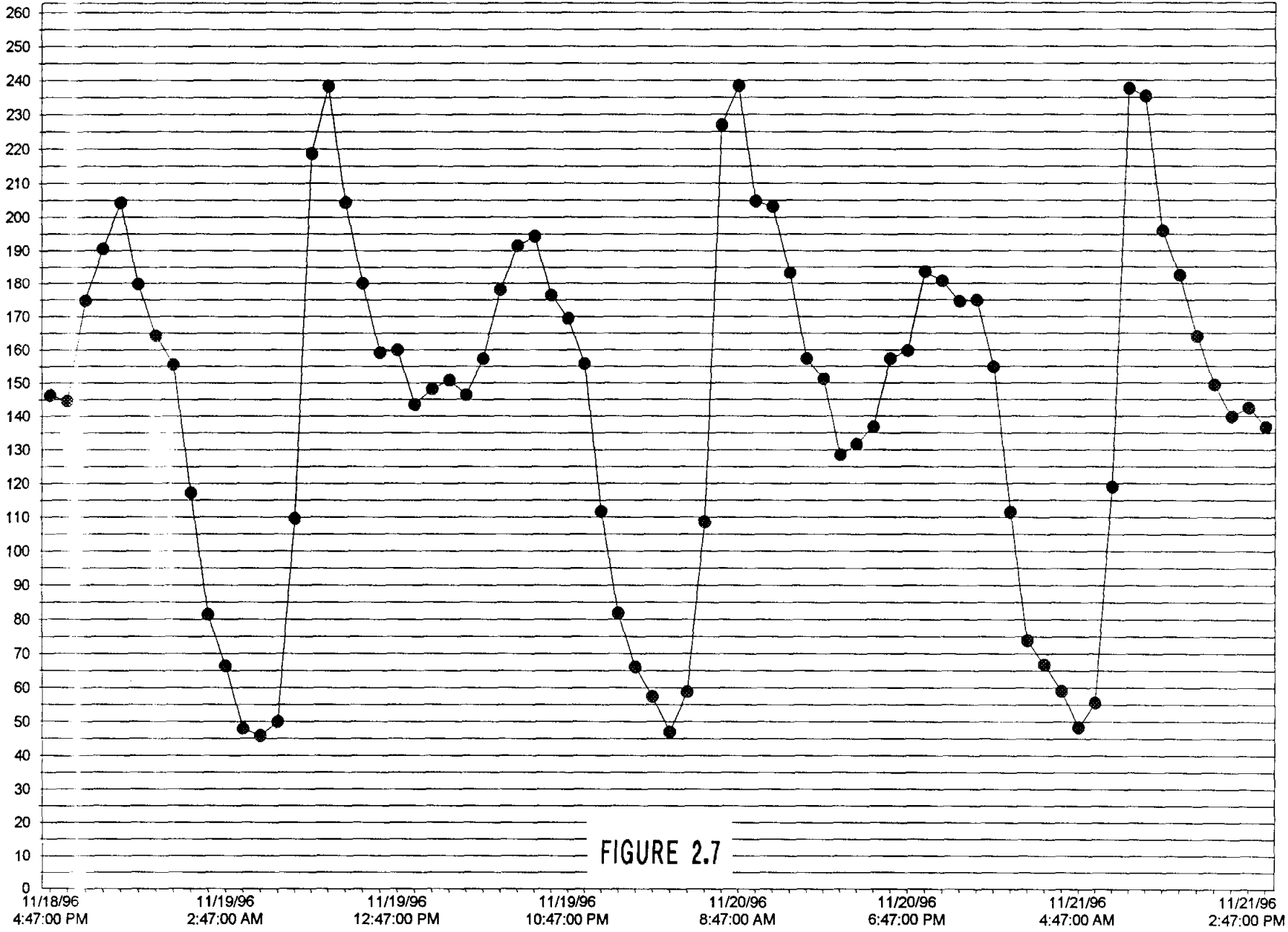

FIGURE 2.7

11/18/96 4:47:00 PM - 11/21/96 5:02:00 PM

Summary Report for Station-Analyzer™

Report Date : 12/2/96	Period : 3 Days
Site : LS_5	Report From : 11/15/96 3:21:00 PM
Description : LS_5	Report To : 11/18/96 3:54:00 PM

Flow Information

Total Flow : 1255021.17 Gallons
Average Inflow Rate : 288.79 GPM
Minimum Inflow Rate : 125.56 GPM @ 11/17/96 7:02:29 AM
Maximum Inflow Rate : 463.20 GPM @ 11/18/96 10:54:58 AM

Pump Information

<u>Pump #</u>	<u># of Starts</u>	<u>Run Hours</u>	<u>% Usage</u>	<u>Avg. Pump Rate</u>
1	493	33.75	100.00%	622.72 GPM
2	0	0.00	0.00%	0.00 GPM
3	0	0.00	0.00%	0.00 GPM
4	0	0.00	0.00%	0.00 GPM

Average Flow Rate for Pump Combinations

<u>Pumps</u>	<u>Pump Rate</u>	<u>Pumps</u>	<u>Pump Rate</u>	<u>Pumps</u>	<u>Pump Rate</u>	<u>Pumps</u>	<u>Pump Rate</u>
1,2	0.00 GPM	2,3	0.00 GPM	1,2,4	0.00 GPM	2,3,4	0.00 GPM
1,3	0.00 GPM	2,4	0.00 GPM	1,2,3	0.00 GPM	1,2,3,4	0.00 GPM
1,4	0.00 GPM	3,4	0.00 GPM	1,3,4	0.00 GPM		

Station Information

Average Pump Time : 4.11 Minutes
Total # of Cycles : 493
Average Fill Time : 4.71 Minutes

Other Events

11/15/96 3:25:47 PM- Maint. OFF

INFLOW RATE
Site:LS_5 LS_5
Period:11/15/96
Period MIN:

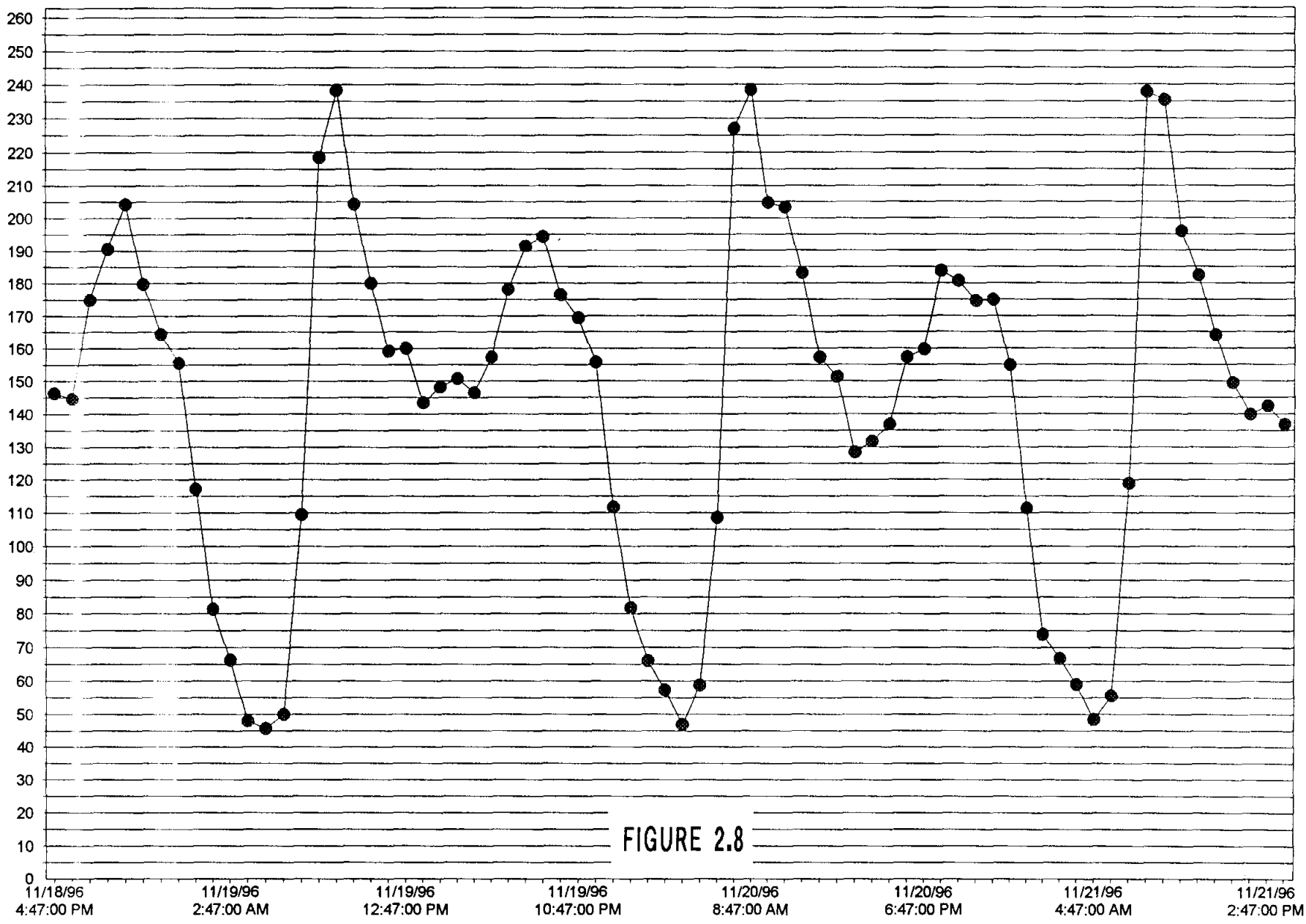

FIGURE 2.8

11/18/96 4:47:00 PM - 11/21/96 5:02:00 PM

Summary Report for Station-Analyzer™

Report Date : 12/2/96 **Period** : 3 Days
Site : LS_12 **Report From** : 11/22/96 9:35:00 AM
Description : MID VALLEY INDUSTRIA **Report To** : 11/25/96 10:00:00 AM

Flow Information

Total Flow : 2110352.33 Gallons
Average Inflow Rate : 489.63 GPM
Minimum Inflow Rate : 3.84 GPM @ 11/25/96 3:48:10 AM
Maximum Inflow Rate : 3260.92 GPM @ 11/22/96 11:31:11 AM

Pump Information

<u>Pump #</u>	<u># of Starts</u>	<u>Run Hours</u>	<u>% Usage</u>	<u>Avg. Pump Rate</u>
1	0	0.00	0.00%	0.00 GPM
2	101	17.14	100.00%	3488.62 GPM
3	0	0.00	0.00%	0.00 GPM
4	0	0.00	0.00%	0.00 GPM

Average Flow Rate for Pump Combinations

<u>Pumps</u>	<u>Pump Rate</u>	<u>Pumps</u>	<u>Pump Rate</u>	<u>Pumps</u>	<u>Pump Rate</u>	<u>Pumps</u>	<u>Pump Rate</u>
1,2	0.00 GPM	2,3	0.00 GPM	1,2,4	0.00 GPM	2,3,4	0.00 GPM
1,3	0.00 GPM	2,4	0.00 GPM	1,2,3	0.00 GPM	1,2,3,4	0.00 GPM
1,4	0.00 GPM	3,4	0.00 GPM	1,3,4	0.00 GPM		

Station Information

Average Pump Time : 10.18 Minutes
Total # of Cycles : 101
Average Fill Time : 32.48 Minutes

Other Events

■ Inflow

Site:LS_12
INFLOW RATE
MID VALLEY INDUSTRIA
Period:11/22/96

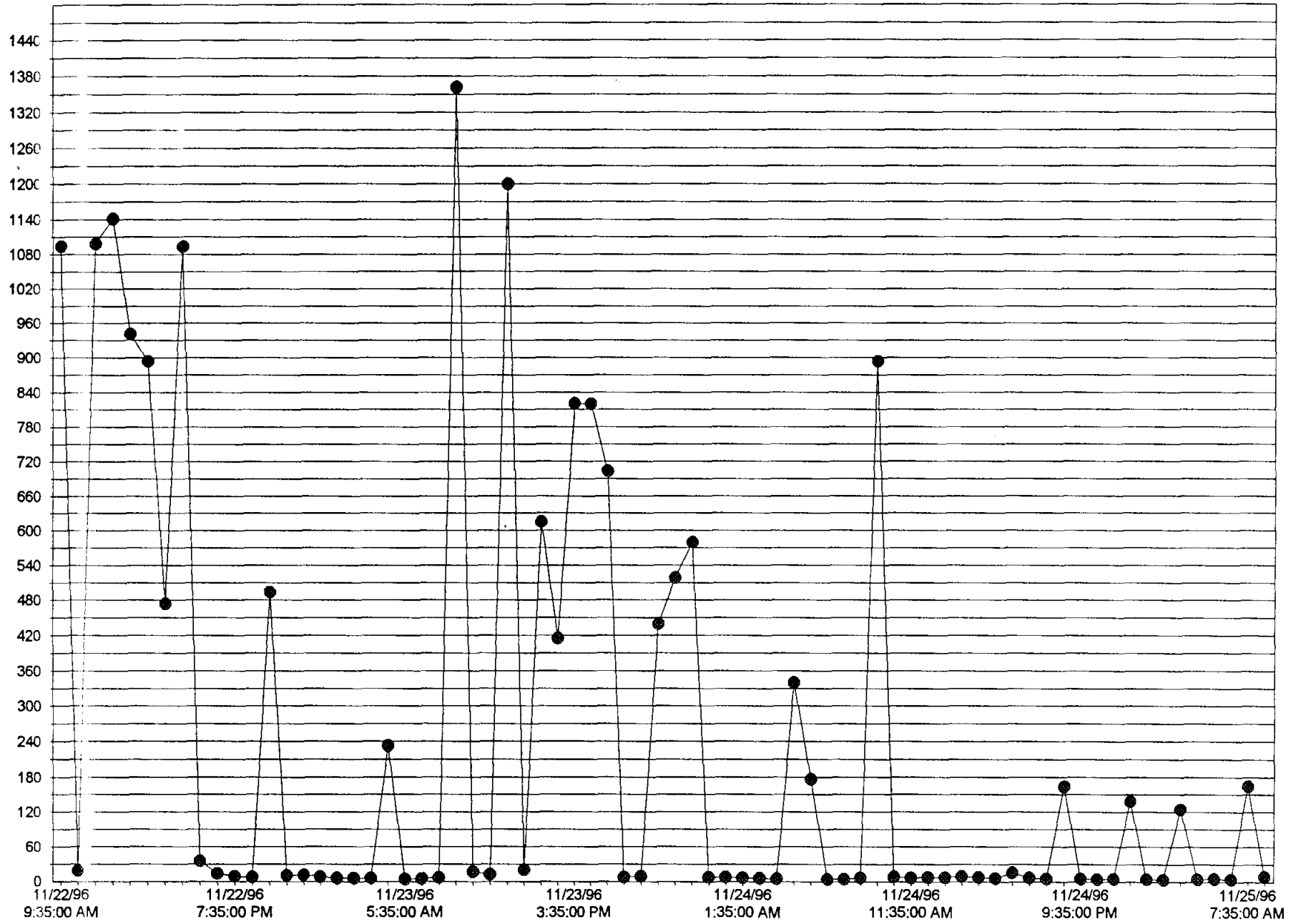

11/22/96 9:35:00 AM - 11/25/96 10:00:00 AM FIGURE 2.10

most likely population series, it was found that the City needs additional capacity to serve up to year 2010. Figure 2.11 shows a graphical representation of the treatment capacity evaluation of both the plants. These evaluations were based on the TWDB's Most Likely Series Population Forecast, and Engineer's estimate of 100 gpcd of system-wide wastewater generation. As it can be seen from the figure, the 1.25 MGD South side plant will be in operation by the end of 1998. The expected flow to the South side plant at the end of 1998 is 0.6 MGD (flows from Lift Stations 3 and 5), and the North side plant will receive approximately 1.8 MGD. By the end of Year 2000, it is estimated that all the houses in the colonias will be connected, and the South side plant will receive about 1.0 MGD. Also, it can be seen from the figure that the existing 2.0 MGD North side plant will be able to serve until year 2001 and the proposed 1.25 MGD will serve until year 2007. However, TNRCC rules (Texas Administrative Code 305. 126) require that plans and specifications be prepared for the expansion of any wastewater treatment facility that exceeds 75% of its permitted average daily flow for three consecutive months. Based on the figure, and by using the best engineering judgment, it is recommended that, the City observe the actual population growth pattern and the incoming flows at both the plants and somewhere in the year 2000, implement a detailed study for determining treatment plant expansion. The study should be based on the average flows and the population growth rates occurring at that time.

If it is determined that the capacity expansion is needed, it is recommended that the South side plant be expanded to at least 2.5 MGD (as proposed in the EDAP-Study). The full capacity of the North side plant (3.0 MGD) can be restored by process modification to the existing trickling filters. Utilizing the existing trickling filters will eliminate the need for a totally new plant on the North side. The following alternates should be considered to utilize the existing trickling filter units at the North side plant:

Alternate 1 - Construction of Aeration Tank

As mentioned earlier, the existing trickling filter units (1.0 MGD capacity) were removed from operation (as they are not able to meet the effluent limits of 10/15/3).

Alternate 1 includes constructing an activated sludge basin (aeration tank) to provide further treatment of effluent from trickling filters. Influent flow will pass through the existing primary clarifiers, then to trickling filters. The trickling filters will function as roughing filters, producing effluent quality that is consistent with current performance data. An aeration tank will be constructed near these trickling filters. Aeration can be provided by fine bubble diffusers or mechanical aerators. All the existing final clarifiers and sludge pumps will continue to be used. However, at this time, the performance of digesters is unknown, and therefore, if deemed necessary, the digesters need to be rehabilitated. The combination of trickling filters and an activated sludge aeration tank, plus the existing oxidation ditch will provide adequate capacity to treat up to 3.0 MGD influent flow while meeting the required 10/15/3 effluent quality. A schematic of the proposed alternate 1 is given in figure 2.12.

Alternate 2 - Conversion of Existing Trickling Filters to Aeration Units:

CITY OF WESLACO - EVALUATION OF WASTEWATER TREATMENT PLANTS CAPACITY

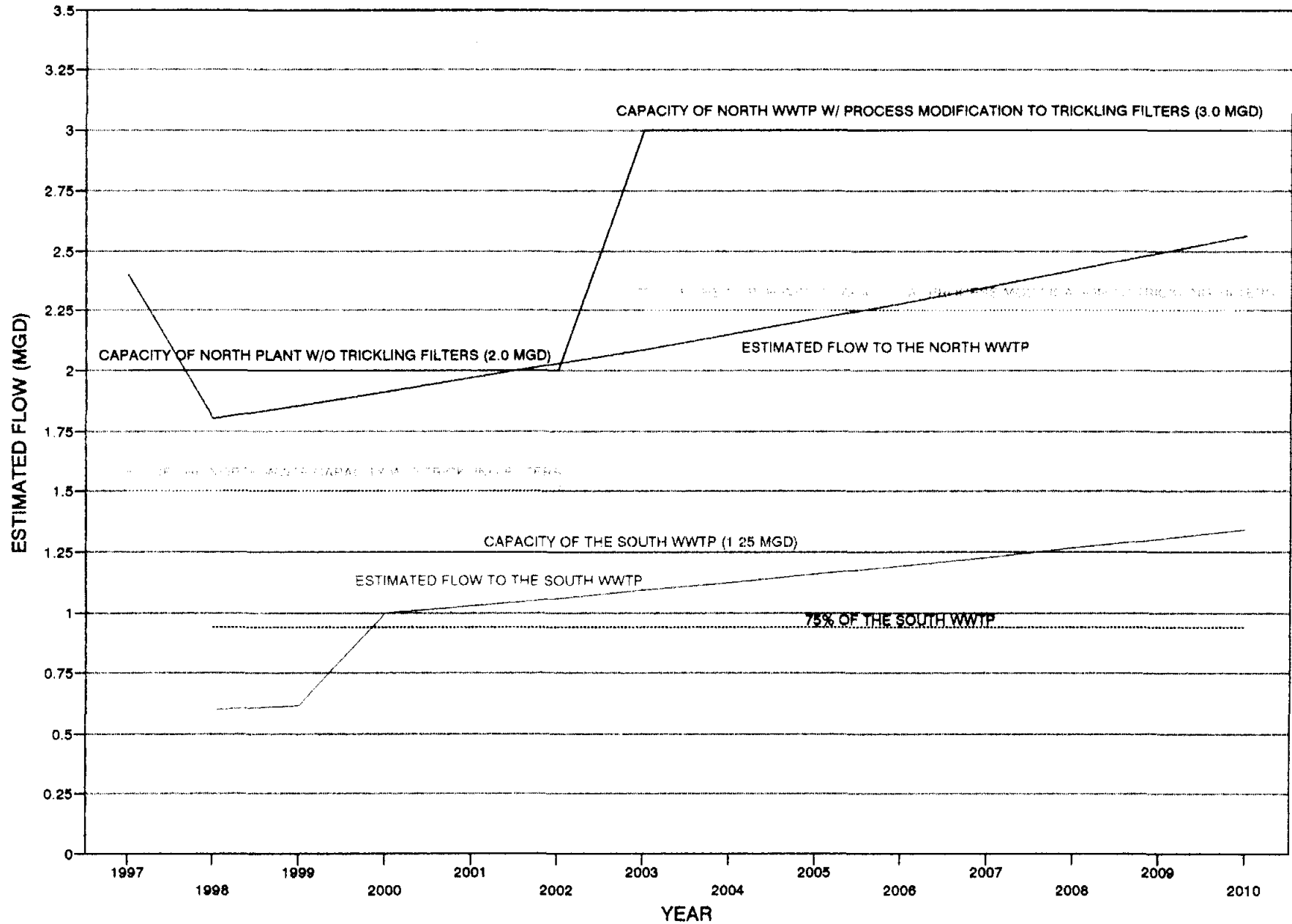

FIGURE 2.11

Another alternate was considered for the upgrade. It is proposed that the trickling filters be modified into activated sludge units. This can be done by increasing the height of the structures so that enough detention is provided. With this alternate, the necessity of constructing a totally new aeration tank can be eliminated. A schematic of the proposed alternate 2 is given in figure 2.12.

The plant hydraulics and the structures of the units need to be further evaluated before implementing the above mentioned alternates.

Odor Control at the North Treatment Plant:

After examining Weslaco's treatment plant, along with taking hydrogen sulfide readings at various locations (See Table 2.4) the following conclusions can be made.

When the wastewater spills over the splitter box, the hydrogen sulfide concentration in the air, inside the splitter box, is more than 500 ppm. This high concentration is very toxic, and also very corrosive. In the summer, the hydrogen sulfide produced increases due to the warmer wastewater, and potentially more gas is liberated. The list below is a set of immediate recommendations based on our findings.

1. Lower the wet well levels in the receiving well by resetting the floats. Lowering of the floats will ensure less hydrogen sulfide production.
2. Recycle the mixed liquor suspended solids (MLSS) to the wet well at the Sewage Treatment Plant. The aerated MLSS can be brought into the wet well to help control odors. The odor control is brought about by the primary contact with the aerated MLSS, raising the dissolved oxygen level and arresting sulfur reducing bacteria.
3. With the BIOXIDE injection at the Lift Station # 10, the plant should receive low concentrations of hydrogen sulfide. Also, with the diversion of flow to the south plant, it is anticipated that the odor problem at the North plant will be minimized. However, it is suggested that a sulfide testing kit is purchased and any changes in the hydrogen sulfide levels should be recorded. If the problem still persists, with the continued injection of BIOXIDE at lift station # 10, an air scrubber and/or a BIOXIDE injection unit should be installed at the headworks of the wastewater treatment plant. The odorous air must be contained and evacuated to the scrubber unit. Again, due to high capital and operational costs involved with the installation and maintenance of these units, the City should implement the installation of the odor control units only after monitoring the hydrogen sulfide levels at the plant.

d) Lift Stations Rehabilitation

Some of the existing lift stations need some minor to major repairs to their buildings, wet well structures, and pumps and accessories. Table 2.5 lists the lift stations that need attention. A cost estimate of rehabilitation of the lift stations is included in the next chapter.

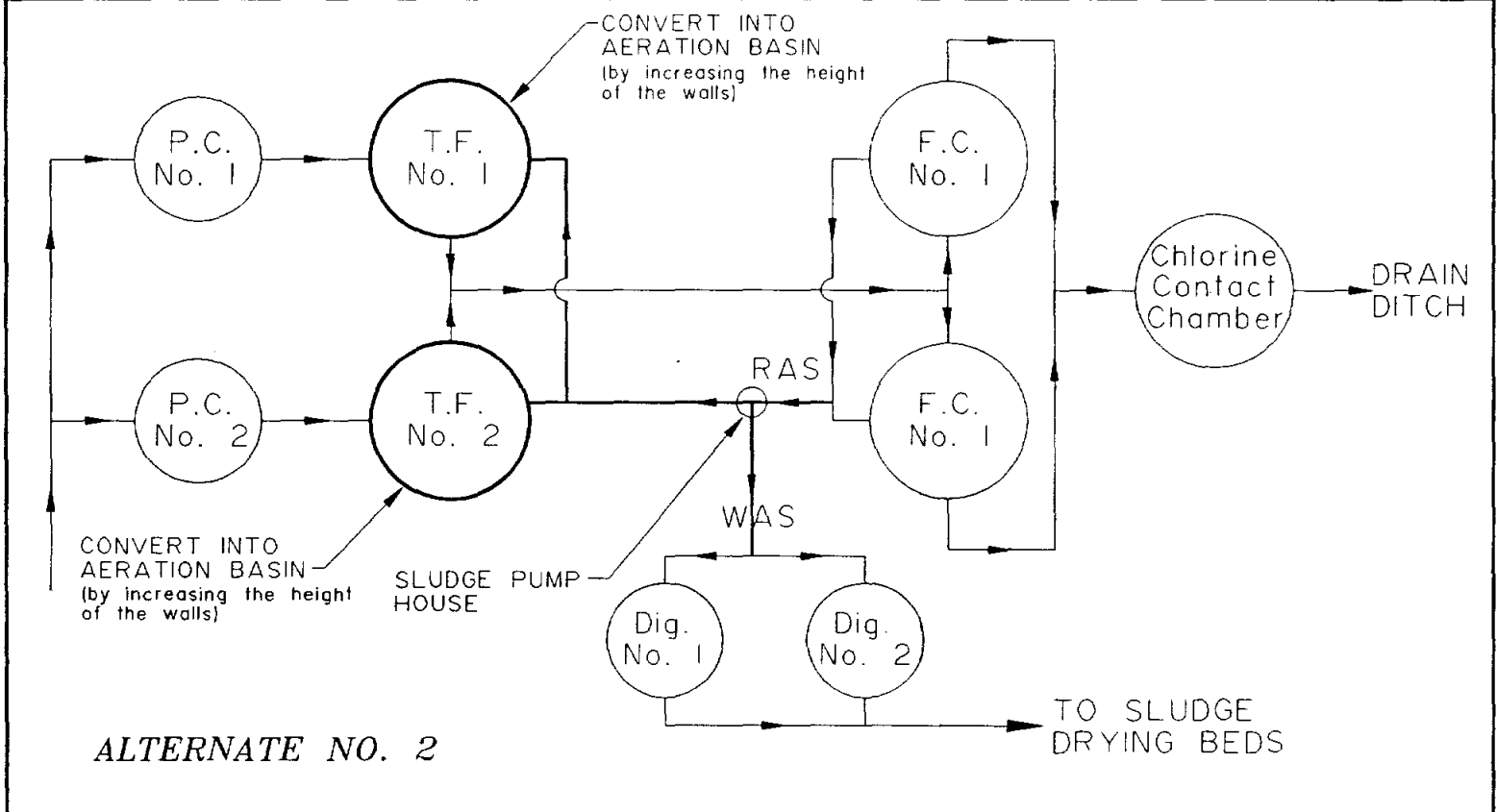
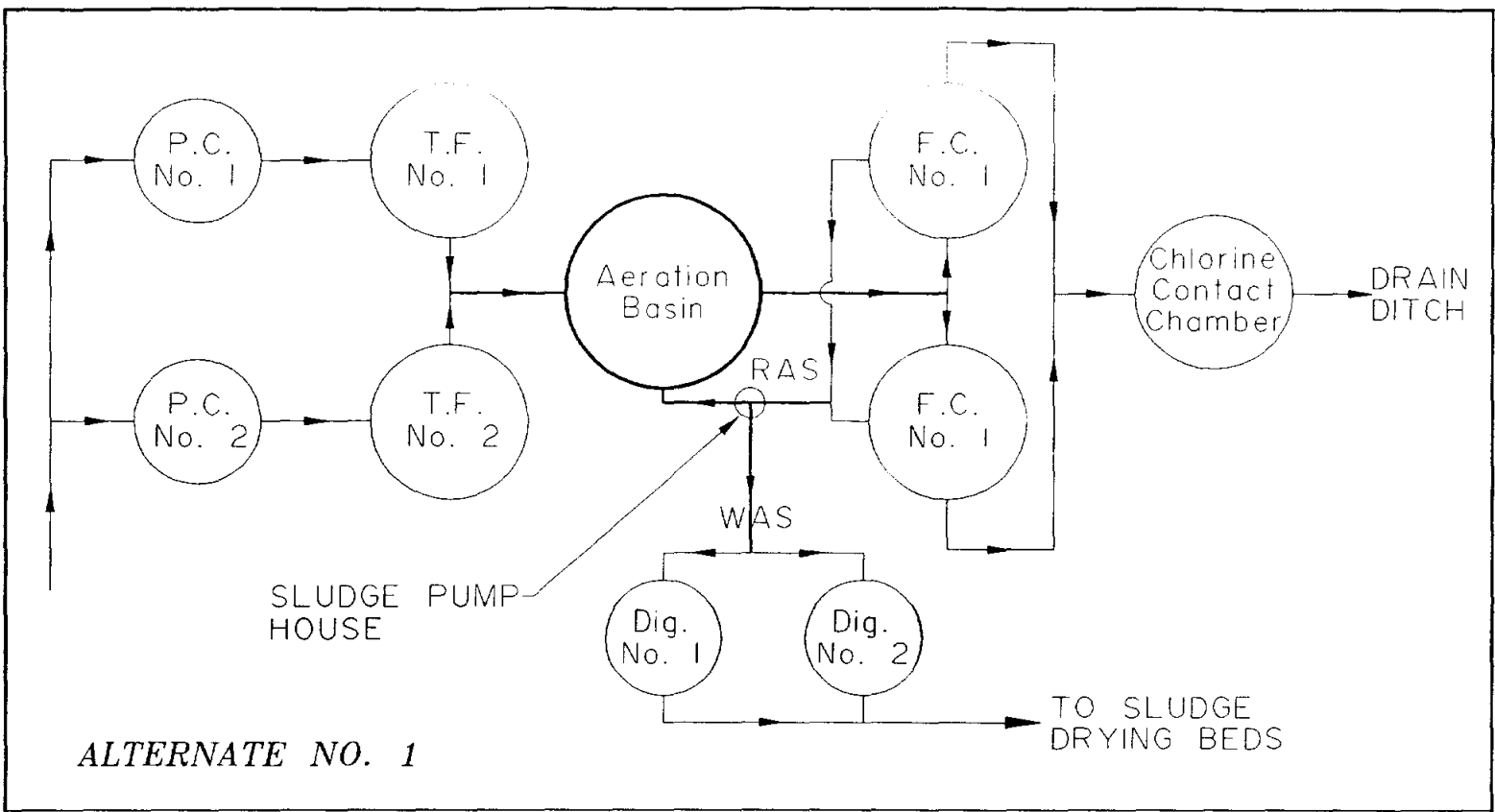

FIGURE 2.12
 PROPOSED MODIFICATIONS TO THE TRICKLING
 FILTER UNITS TO MEET EFFLUENT DISCHARGE LIMITS

P.C.-PRIMARY CLARIFIER
 T.F.-TRICKLING FILTER
 F.C.-FINAL CLARIFIER

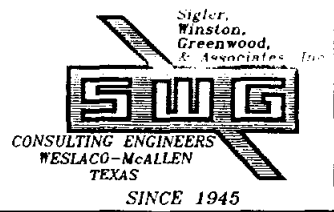

Table 2.5

Rehabilitation of Existing Lift Stations

Lift Station #	Location	Rehab Item	Remarks
LS 1	First & Garza	Rehab Roof of Bldg. Install Fence Replace Electrical Replace Pump # 2	Old block building with wet and dry well located inside. The building has been subject to vandalism and has broken windows and other exterior damage. Roof is also rusted through.
LS 2	Texas & Agostadero	Installation of door, frame & paint Resurfacing of Wet Well Replace Motors Replace Pumps Replace Valves Replace Drive Shafts Sand blast & paint - pumps & pipes	Old brick building in poor condition.
LS 3	Tula & Stone	Paint Building Coat Wet Well Upgrade electrical System Replace Pumps Replace Drive Shafts Sand blast & paint - pumps & pipes	
LS 4	Oregon & Hwy. 83	Replace bldg. Rehab Wet Well Replace Electrical Replace Pumps Replace Valves Replace Drive Shafts Sand blast & paint - pumps & pipes	Old brick building in very poor condition. Major rehabilitation is required.
LS 5	S. Bridge St.	Install Fence Rehab Wet Well Replace Electrical Replace Pump # 2 Replace Drive Shafts Sand blast & paint - pumps & pipes	Large brick building in poor condition. Needs major rehabilitation.
LS 6	Pat Cannon St.	Paint Bldg.	Wood building in fair condition.
LS 7	Back of sewer plant	None	High Flow station. Not in use.
LS 8	M 10 N	None	High Flow station. Not in use.
LS 9	Plaza & Iowa	Repair Fence Replace Metal Sheet Bldg. Replace Electrical Replace Valves Replace Drive Shafts Sand blast & paint - pumps & pipes	Old sheet metal building in very poor condition. Needs major renovation. This station is high priority.
LS 10	Torritos & Illinois	Paint and install new doors (bldg.) Replace Drive Shafts (One)	Brick building in fair condition. Has odor problems.
LS 11		Replace Fence Resurface Wet Well	Brick building in fair condition.

Table 2.5 (Continued..)

Rehabilitation of Existing Lift Stations

Lift Station #	Location	Rehab Item	Remarks
LS 12	M 3 W & Joe Stephen	Replace bldg. Replace Electrical Replace Valves Sand blast & paint - pumps & pipes	Old sheet metal building in very poor condition.
LS 13	Leisure World Park Mobile	Repair Fence Sand blast & paint - pumps & pipes	Self priming duplex station
LS 14	Mile 6 West	None	Duplex self priming with stainless steel cov
LS 15	McManus Produce	None	New duplex self priming station
LS 16	Mile 3 W, S/ Siesta Vill	Replace Valves Replace Fiberglass Cover	Duplex crown pump station with fiber glass cover.
LS 17	M 4 W & 18th st.	Install Bldg., rehab Wet well, Replace electrical, piping, valves etc.	Old open pit submersible pump station. Needs major upgrade.
LS 18	M 9 N and 4 1/2 W	Repair Fence Replace Pump Replace Valves	Crown duplex with fiber glass cover.
LS 19	Tejas Subd.	None	Hydromatic self priming duplex station.
LS 20	S. Tx. & Hidden Valley	Replace Fiberglass Covers	Self priming station in good condition.
LS 21	Mile 3W & Palm Aire Motel	Rebuild Pumps Replace Valves Sand Blast & Paint	Crown duplex station in good condition.
LS 22	Sherry Barbee & Hwy. 83	Replace Pumps Replace Fiberglass Covers	Crown duplex station in poor condition.
LS 23	De Los Santos St.	Replace Pumps Replace Valves	Crown duplex station.
LS 24	Dickens	Replace Valves Sand blast & paint - pumps & pipes	
LS 25	Center Point	None	Crown duplex station in good condition
LS 26	FM 1015 & M 9 N	None	Self priming pump station in good condition
LS 27	FM 1015 & Trailer Park	None	Submersible pump station in good condition
LS 28	Sugarcane road.	None	Self priming pump station in good condition
LS 29	Mile 6 & Mile 9	None	New submersible pump station
LS 30	18th St. & Border	None	New submersible pump station

The above information is courtesy of OMI.

e) Miscellaneous

TNRCC regulations (30 TAC 317.13) call for a minimum 2.0 feet per second velocity in all gravity lines. Also, the regulations call for a minimum of 9 feet separation distance between a sewer line and water line. It is very important to follow these guidelines for all the new lines that are proposed. These guidelines are as follows:

(a) Water line/new sewer line separation. When new sanitary sewers are installed, they shall be installed no closer to waterlines than nine feet in all directions. Sewers that parallel waterlines must be installed in separate trenches. Where the nine foot separation distance cannot be achieved, the following guidelines will apply:

(1) Where a sanitary sewer parallels a waterline, the sewer shall be constructed of cast iron, ductile iron or PVC meeting ASTM specifications with a pressure rating for both the pipe and joints of 150 psi. The vertical separation shall be a minimum of two feet between outside diameters and the horizontal separation shall be a minimum of four feet between outside diameters. The sewer shall be located below the waterline.

(2) Where a sanitary sewer crosses a waterline and the sewer is constructed of cast iron, ductile iron or PVC with a minimum pressure rating of 150 psi, an absolute minimum distance of 6 inches between outside diameters shall be maintained. In addition the sewer shall be located below the waterline where possible and one length of the sewer pipe must be centered on the waterline.

(3) Where a sewer crosses under a waterline and the sewer is constructed of ABS truss pipe, similar semi-rigid plastic composite pipe, clay pipe or concrete pipe with gasketed joints, a minimum two foot separation distance shall be maintained. The initial backfill shall be cement stabilized sand (two or more bags of cement per cubic yard of sand) for all sections of sewer within nine feet of the waterline. This initial backfill shall be from one quarter diameter below the centerline of the pipe to one pipe diameter (but not less than 12 inches) above the top of the pipe.

(4) Where a sewer crosses over a waterline all portions of the sewer within nine feet of the waterline shall be constructed of cast iron, ductile iron, or PVC pipe with a pressure rating of at least 150 psi using appropriate adapters. In lieu of this procedure the new conveyance may be encased in a joint of 150 psi pressure class pipe at least 18 feet long and two nominal sizes larger than the new conveyance. The space around the carrier pipe shall be supported at 5 feet intervals with spacers or be filled to the spring line with washed sand. The encasement pipe should be centered on the crossing and both ends sealed with cement grout or manufactured seal.

(b) Water line/manhole separation. Unless sanitary sewer manholes and the connecting sewer can be made watertight and tested for no leakage, they must be installed so as to provide a minimum of nine feet of horizontal clearance from an existing or proposed waterline. Where the nine foot separation distance cannot be achieved, a carrier pipe as described in subsection (a)(4) of this section may be used where appropriate.

CHAPTER 3

COST ESTIMATION OF THE IMPROVEMENTS

1. Preliminary Cost Estimate

An Engineer's opinion of probable construction cost is provided for all the improvements discussed in the study. The cost estimate is based on manufacturer's budget prices and discussions with local contractors. Also, bid tabulations of prior wastewater projects of Weslaco were used to determine the costs. The overall cost summary for wastewater system improvements is given in Table 3.1.

The costs shown in the report are based on the current (1996) prices. It is suggested that the cost of improvements be adjusted based on the actual year of implementation/construction and by considering the annual inflation rate. It should be noted that these estimates are not final and subject to revision at the time of final design phase.

For the purpose of the study, the City wide improvements are divided as:

Southwest Quadrant Improvements - South of 6th St. (Mile 7 N) and West of Texas Blvd.
(Mile 5 W)

Southeast Quadrant Improvements - South of 6th St. & East of Texas Blvd.

Northwest Quadrant Improvements - North of 6th St. and West of Texas Blvd.

Northeast Quadrant Improvements - North of 6th St. and East of Texas Blvd.

Tables 3.2 through 3.5 shows the cost estimates for the collection system improvements in each quadrant. Cost involved in the rehabilitation of lift stations is given in Table 3.6.

Table 3.1

COST SUMMARY OF PROPOSED IMPROVEMENTS

Item	Cost	Remarks
Southwest Improvements	\$2,143,225.00	
Southeast Improvements	\$533,950.00	
Northwest Improvements	\$2,474,118.00	
Northeast Improvements	\$961,475.00	
Lift Stations Rehabilitation	\$519,290.00	
Engineering Study	\$75,000.00	
Upgrade of North WWTP to 3.0 MGD	\$1,000,000.00	Process modification to serve future growth on North side
1.25 MGD Addition to South Plant	\$1,800,000.00	To serve future growth on the South side
Subtotal	\$9,507,058.00	
Contingency (15%)*	\$1,426,058.70	
Engineering (7%)	\$665,494.06	
TOTAL	\$11,598,610.76	

* 15% contingency to cover miscellaneous connections, unidentified utilities relocation, possible additional bores, precautions, traffic control and other conditions not anticipated at this preliminary report level.

Cost Estimate for BIOXIDE Treatment for Odor Control

Item	Cost	Remarks
Odor Control at Lift Station 10	\$75,000.00	Per Year
Odor Control at Lift Station 5	\$60,000.00	Per Year
Subtotal	\$135,000.00	
Contingency (5%)	\$6,750.00	
TOTAL	\$141,750.00	Per Year

Table 3.2

**WASTEWATER COLLECTION SYSTEM
PROPOSED IMPROVEMENTS**

Southwest Quadrant

Item	Item Description	Quantity	Units	Unit Cost (\$)	Item Cost (\$)	Remarks/ Total Cost
SW1	15-inch PVC on M 6 1/2 W (from M 5 N to M 6 N)					
A	18' - 20' deep	3000	L.F.	75.00	225,000.00	
B	16' - 18' deep	1200	L.F.	60.00	72,000.00	
C	Manholes 18' - 20' deep	7	EA	3,750.00	26,250.00	
D	Manholes 16' - 18' deep	4	EA	3,200.00	12,800.00	
E	Suspended Ditch Crossing	1	LS	10,000.00	10,000.00	One crossing
	Total for SW1					\$346,050.00
SW2	15-inch PVC on M 6 1/2 W (from M 6 N to M 6 1/2 N)					
A	16' - 18' deep	2600	L.F.	60.00	156,000.00	
B	Manholes 16' - 18' deep	5	EA	3,200.00	16,000.00	
C	Suspended Ditch Crossing	1	LS	10,000.00	10,000.00	One crossing
	Total for SW2					\$182,000.00
SW3	12-inch PVC on M 6 N (from M 6 1/2 W to M 7 W)					
A	16' - 18' deep	1000	L.F.	45.00	45,000.00	
B	12' - 14' deep	1600	L.F.	40.00	64,000.00	
C	Manholes 18' - 20' deep	2	EA	3,200.00	6,400.00	
D	Manholes 12' - 14' deep	3	EA	2,475.00	7,425.00	
	Total for SW3					\$122,825.00
SW4	10-inch PVC on M 7 W (to serve Alamo Alta Subd.)					
A	10' - 12' deep	1500	L.F.	30.00	45,000.00	
B	Manholes 10' - 12' deep	4	EA	2,000.00	8,000.00	
	Total for SW4					\$53,000.00
SW5	8-inch PVC laterals (to serve Alamo Alta Subd.)					
A	8' - 10' deep	3000	L.F.	25.00	75,000.00	
B	Manholes 8' - 10' deep	6	EA	1,600.00	9,600.00	
	Total for SW5					\$84,600.00
SW6	12-inch PVC on M 6 1/2 W (from M 7 N to M 6 3/4 N)					
A	10' - 12' deep	1500	L.F.	35.00	52,500.00	
B	Manholes 10' - 12' deep	3	EA	2,000.00	6,000.00	
	Total for SW6					\$58,500.00

Table 3.2 (Continued..)

WASTEWATER COLLECTION SYSTEM
PROPOSED IMPROVEMENTS

Southwest Quadrant (Continued..)

Item	Item Description	Quantity	Units	Unit Cost (\$)	Item Cost (\$)	Remarks/ Total Cost
SW7	12 -inch PVC to serve La Palma Subd. (sub main)					
A	6' - 8' deep	1300	L.F.	25.00	32,500.00	
B	Manholes 6' - 8' deep	4	EA	1,350.00	5,400.00	
	Total for SW7					\$37,900.00
SW8	8 & 10-inch PVC laterals (to serve La Palma Subd.)					
A	8-inch 6' - 8' deep	3900	L.F.	20.00	78,000.00	
B	10-inch 4' - 6' deep	1300	L.F.	12.00	15,600.00	
C	Manholes 6' - 8' deep	9	EA	1,350.00	12,150.00	
D	Manholes 4' - 6' deep	3	EA	1,150.00	3,450.00	
	Total for SW8					\$109,200.00
SW9	18-inch PVC on M 5 1/2 W (from M 6 N to M 5 1/2 N)					
A	16' - 18' deep	2000	L.F.	72.00	144,000.00	
B	14' - 16' deep	1100	L.F.	60.00	66,000.00	
C	Manholes 18' - 20' deep	4	EA	3,750.00	15,000.00	
D	Manholes 12' - 14' deep	4	EA	2,500.00	10,000.00	
	Total for SW9					\$235,000.00
SW10	12-inch PVC on M 5 1/2 W (from M 5 1/2 N to SW of Quail Hollow Subd.)					
A	12' - 14' deep	1000	L.F.	40.00	40,000.00	
B	10' - 12' deep	500	L.F.	35.00	17,500.00	
C	Manholes 12' - 14' deep	2	EA	2,500.00	5,000.00	
D	Manholes 10' - 12' deep	3	EA	2,000.00	6,000.00	
	Total for SW10					\$68,500.00
SW11	6-inch PVC Pressure Main (from LS on SW of Sun Valley Subd. to M 5 1/2 W)					
A	4' - 6' deep	1200	L.F.	10.00	12,000.00	
B	Switching Pressure Main	1	LS	5,000.00	5,000.00	
	Total for SW11					\$17,000.00
SW12	15-inch PVC on M 6 N (from LS on SW of Sun Valley Subd. to M 6 W)					
A	16' - 18' deep	1000	L.F.	60.00	60,000.00	
B	14' - 16' deep	1700	L.F.	50.00	85,000.00	
C	Manholes 16' - 18' deep	2	EA	3,200.00	6,400.00	
D	Manholes 14' - 16' deep	3	EA	2,500.00	7,500.00	
	Total for SW12					\$158,900.00

Table 3.2 (Continued..)

**WASTEWATER COLLECTION SYSTEM
PROPOSED IMPROVEMENTS**

Southwest Quadrant (Continued..)

Item	Item Description	Quantity	Units	Unit Cost (\$)	Item Cost (\$)	Remarks/ Total Cost
SW13	12-inch on M 6 W (from M 6 N to M 6 3/4 N)					
A	10' - 12' deep	1000	L.F.	35.00	35,000.00	
B	8' - 10' deep	2000	L.F.	30.00	60,000.00	
C	6' - 8' deep	1000	L.F.	25.00	25,000.00	
D	Manholes 10' - 12' deep	2	EA	2,000.00	4,000.00	
E	Manholes 8' - 10' deep	4	EA	1,600.00	6,400.00	
F	Manholes 6' - 8' deep	2	EA	1,350.00	2,700.00	
	Total for SW13					\$133,100.00
SW14	12-inch on M 5 1/4 N (to serve Westgate etc.)					
A	14' - 16' deep	1800	L.F.	45.00	81,000.00	
B	Manholes 14' - 16' deep	4	EA	2,500.00	10,000.00	
	Total for SW14					\$91,000.00
SW15	12-inch PVC on Woodland Dr. (to serve Westgate Woods Subd.)					
A	10' - 12' deep	2200	L.F.	35.00	77,000.00	
B	Manholes 10' - 12' deep	6	EA	2,000.00	12,000.00	
	Total for SW15					\$89,000.00
SW16	8 & 10-inch laterals in Westgate Woods Subd.					
A	10-inch 8' - 10' deep	500	L.F.	25.00	12,500.00	
B	8-inch 4' - 6' deep	6200	L.F.	12.00	74,400.00	
C	Manholes 8' - 10' deep	2	EA	1,600.00	3,200.00	
D	Manholes 4' - 6' deep	14	EA	1,150.00	16,100.00	
	Total for SW16					\$106,200.00
SW17	12-inch PVC on M 6 W to serve portions of Westgate Woods and surrounding areas					
A	4' - 6' deep	1200	L.F.	18.00	21,600.00	
B	Manholes 4' - 6' deep	1	LS	1,150.00	1,150.00	
	Total for SW17					\$22,750.00
SW18	6 & 12-inch laterals in Citrus Retreat Subd.					
A	12-inch 10' - 12' deep	2000	L.F.	35.00	70,000.00	
B	6-inch 4' - 6' deep	4200	L.F.	10.00	42,000.00	
C	Manholes 10' - 12' deep	6	EA	2,000.00	12,000.00	
D	Manholes 4' - 6' deep	12	EA	1,150.00	13,800.00	
	Total for SW18					\$137,800.00

Table 3.2 (Continued..)

WASTEWATER COLLECTION SYSTEM
PROPOSED IMPROVEMENTS

Southwest Quadrant (Continued..)

Item	Item Description	Quantity	Units	Unit Cost (\$)	Item Cost (\$)	Remarks/ Total Cost
SW19	8 -inch PVC on M 5 1/2 W (from M 6 N to S. of Canal)					
A	4' - 6' deep	1000	L.F.	12.00	12,000.00	
B	Manholes 4' - 6' deep	2	EA	1,150.00	2,300.00	
	Total for SW19					\$14,300.00
SW20	6-inch PVC laterals in Bellaire Subd.					
A	6' - 8' deep	5000	L.F.	12.00	60,000.00	
B	Manholes 6' - 8' deep	12	EA	1,300.00	15,600.00	
	Total for SW20					\$75,600.00
TOTAL COST FOR SOUTHWEST QUADRANT IMPROVEMENTS:						\$2,143,225.00

Table 3.3

**WASTEWATER COLLECTION SYSTEM
PROPOSED IMPROVEMENTS**

Southeast Quadrant

Item	Item Description	Quantity	Units	Unit Cost (\$)	Item Cost (\$)	Remarks/ Total Cost
SE1	15 -inch PVC on M 5 N (from M 3 1/2 W to M 3 W)					
A	14' - 16' deep	500	L.F.	50.00	25,000.00	
B	12' - 14' deep	1500	L.F.	45.00	67,500.00	
C	Manholes 14' - 16' deep	2	EA	2,900.00	5,800.00	
D	Manholes 12' - 14' deep	2	EA	2,500.00	5,000.00	
	Total for SE1					\$103,300.00
SE2	15 -inch PVC on M 3 W (from M 5 N to M 5 1/2 N)					
A	10' - 12' deep	3000	L.F.	38.00	114,000.00	
B	Manholes 10' - 12' deep	7	EA	2,000.00	14,000.00	
	Total for SE2					\$128,000.00
SE3	6-inch PVC Pressure Main (From LS at Siesta Village to M 3 W)					To provide a shorter route.
A	4' - 6' deep	200	L.F.	10.00	2,000.00	
B	Switching Pressure Main	1	LS	5,000.00	5,000.00	
	Total for SE3					\$7,000.00
SE4	15-inch PVC on M 3 W (from LS at 1015 RV Park to M 6 1/2 N)					
A	8' - 10' deep	1000	L.F.	35.00	35,000.00	
B	Manholes 8' - 10' deep	2	EA	1,600.00	3,200.00	
	Total for SE4					\$38,200.00
SE5	15-inch PVC on M 6 1/2 N (to serve South Palm Gardens)					
A	8' - 10' deep	1400	L.F.	35.00	49,000.00	
B	Manholes 8' - 10' deep	3	EA	1,600.00	4,800.00	
	Total for SE5					\$53,800.00
SE6	8 & 10-inch PVC laterals in South Palm Gardens					
A	10-inch 4' - 6' deep	800	L.F.	14.00	11,200.00	
B	8-inch 4' - 6' deep	600	L.F.	12.00	7,200.00	
C	Manholes 4' - 6' deep	5	EA	1,150.00	5,750.00	
	Total for SE6					\$24,150.00

Table 3.3 (Continued..)

WASTEWATER COLLECTION SYSTEM
PROPOSED IMPROVEMENTS

Southeast Quadrant (Continued..)

Item	Item Description	Quantity	Units	Unit Cost (\$)	Item Cost (\$)	Remarks/ Total Cost
SE7	6 -inch PVC Pressure Main (from LS at 1015 RV Park to US HWY 83)					
A	4' - 6' deep	2800	L.F.	10.00	28,000.00	
B	Abandon Existing 3-inch Pressure Main	1	LS	5,000.00	5,000.00	
	Total for SE7					\$33,000.00
SE8	12-inch on M 5 1/2 N (from Drain Ditch to M 3 1/2 W)					
A	10' - 12' deep	2200	L.F.	35.00	77,000.00	
B	Manholes 10' - 12' deep	7	EA	2,000.00	14,000.00	
	Total for SE8					\$91,000.00
SE9	8 & 12-inch PVC to Serve Kaymar Subd.					
A	12-inch 8' - 10' deep	800	L.F.	30.00	24,000.00	
B	8-inch 6' - 8' deep	1200	L.F.	20.00	24,000.00	
C	Manholes 8' - 10' deep	3	EA	1,600.00	4,800.00	
D	Manholes 6' - 8' deep	2	EA	1,350.00	2,700.00	
	Total for SE9					\$55,500.00

TOTAL COST FOR SOUTHEAST QUADRANT IMPROVEMENTS:	\$533,950.00
--	---------------------

Table 3.4

**WASTEWATER COLLECTION SYSTEM
PROPOSED IMPROVEMENTS**

Northeast Quadrant

Item	Item Description	Quantity	Units	Unit Cost (\$)	Item Cost (\$)	Remarks/ Total Cost
NE1	12 -inch PVC on M 3 1/2 W (from EXPY to M 7 N)					
A	10' - 12' deep	1500	L.F.	35.00	52,500.00	
B	8' - 10' deep	2000	L.F.	30.00	60,000.00	
C	Manholes 10' - 12' deep	3	EA	2,000.00	6,000.00	
D	Manholes 8' - 10' deep	4	EA	1,600.00	6,400.00	
	Total for NE1					\$124,900.00
NE2	12 -inch PVC on M 4 W (from M 7 3/4 N to 7 1/2 N)					
A	8' - 10' deep	1400	L.F.	30.00	42,000.00	
B	Manholes 8' - 10' deep	3	EA	1,600.00	4,800.00	
	Total for NE2					\$46,800.00
NE3	8-inch PVC on M 2 1/2 W (From M 9 N to M 8 1/2 N)					
A	10' - 12' deep	2000	L.F.	30.00	60,000.00	
B	Manholes 10' -12' deep	5	LS	2,000.00	10,000.00	
	Total for NE3					\$70,000.00
NE4	8-inch PVC on M 3 W (From M 9 1/4 N to M 9 N)					
A	10' - 12' deep	1300	L.F.	30.00	39,000.00	
B	Manholes 10' -12' deep	3	LS	2,000.00	6,000.00	
	Total for NE4					\$45,000.00
NE5	Lift Station and Pressure Main on M 4 1/2 W (Intersection of M 10 N)					
A	Lift Station - Structure & Pumps etc.	1	LS	200,000.00	200,000.00	
B	8-inch Pressure Main on M 4 1/2 W	5200	L.F.	12.00	62,400.00	
C	Canal Crossing	1	LS	20,000.00	20,000.00	One crossing
	Total for NE5					\$282,400.00
NE6	8-inch PVC on M 4 1/2 W (to serve Mid Valley Estates)					
A	12' - 14' deep	800	L.F.	35.00	28,000.00	
B	Manholes 12' - 14' deep	2	EA	2,475.00	4,950.00	
	Total for NE6					\$32,950.00

Table 3.4 (Continued..)

WASTEWATER COLLECTION SYSTEM
PROPOSED IMPROVEMENTS

Northeast Quadrant (Continued..)

Item	Item Description	Quantity	Units	Unit Cost (\$)	Item Cost (\$)	Remarks/ Total Cost
NE7	6 & 8-inch PVC laterals to server Mid Valley Estates					
A	8-inch 6' - 8' deep	700	L.F.	20.00	14,000.00	
B	6-inch 4' - 6' deep	1500	L.F.	10.00	15,000.00	
C	Manholes 6' - 8' deep	2	EA	1,300.00	2,600.00	
D	Manholes 4' - 6' deep	6	EA	1,150.00	6,900.00	
	Total for NE7					\$38,500.00
NE8	12-inch on M 10 N (from M 4 1/2 W to M 5 W)					
A	12' - 14' deep	2600	L.F.	40.00	104,000.00	
B	Manholes 12' - 14' deep	5	EA	2,475.00	12,375.00	
	Total for NE8					\$116,375.00
NE9	12-inch on M 5 W (from M 10 N to M 9 1/4 N)					
A	8' - 10' deep	4000	L.F.	30.00	120,000.00	
B	Manholes 8' - 10' deep	8	EA	1,600.00	12,800.00	
	Total for NE9					\$132,800.00
NE10	12-inch on M 8 N (from M 3 1/2 W to M 3 W)					
A	6' - 8' deep	2600	L.F.	25.00	65,000.00	
B	Manholes 6' - 8' deep	5	EA	1,350.00	6,750.00	
	Total for NE10					\$71,750.00

TOTAL COST FOR NORTHEAST QUADRANT IMPROVEMENTS:	\$961,475.00
--	---------------------

Table 3.5

**WASTEWATER COLLECTION SYSTEM
PROPOSED IMPROVEMENTS**

Northwest Quadrant

Item	Item Description	Quantity	Units	Unit Cost (\$)	Item Cost (\$)	Remarks/ Total Cost
NW1	12-inch PVC on M 10 N (from M 5 W to M 6 W)					
A	10' - 12' deep	5200	L.F.	35.00	182,000.00	
B	Manholes 10' - 12' deep	11	EA	2,000.00	22,000.00	
	Total for NW1					\$204,000.00
NW2	8 & 10-inch laterals to serve Country Aire Ests.					
A	10-inch 8' - 10' deep	1000	L.F.	25.00	25,000.00	
B	8-inch 6' - 8' deep	2000	L.F.	20.00	40,000.00	
C	Manholes 8' - 10' deep	3	EA	1,600.00	4,800.00	
D	Manholes 6' - 8' deep	5	EA	1,300.00	6,500.00	
	Total for NW2					\$76,300.00
NW3	12-inch PVC on M 9 1/2 N (from M 5 W to M 5 1/2 W)					
A	8' - 10' deep	2600	L.F.	30.00	78,000.00	
B	Manholes 8' - 10' deep	5	LS	1,600.00	8,000.00	
	Total for NW3					\$86,000.00
NW4	8-inch PVC to serve San Fransico Subd.					
A	6' - 8' deep	1300	L.F.	30.00	39,000.00	
B	Manholes 6' - 8' deep	3	LS	2,000.00	6,000.00	
	Total for NW4					\$45,000.00
NW5	12-inch PVC on M 9 N to serve Sun Country Estates					
A	8' - 10' deep	500	L.F.	30.00	15,000.00	
B	Manholes 8' - 10' deep	3	EA	1,600.00	4,800.00	
	Total for NW5					\$19,800.00
NW6	6 & 8-inch PVC laterals to serve Sun Country Ests.					
A	8-inch 6' - 8' deep	1200	L.F.	30.00	36,000.00	
B	6-inch 4' - 6' deep	2400	L.F.	10.00	24,000.00	
C	Manholes 6' - 8' deep	4	EA	1,300.00	5,200.00	
D	Manholes 4' - 6' deep	4	EA	1,150.00	4,600.00	
	Total for NW6					\$69,800.00

Table 3.5 (Continued..)

**WASTEWATER COLLECTION SYSTEM
PROPOSED IMPROVEMENTS**

Northwest Quadrant (Continued..)

Item	Item Description	Quantity	Units	Unit Cost (\$)	Item Cost (\$)	Remarks/ Total Cost
NW7	12-inch PVC on M 6 1/2 W (from LS to M 8 1/2 N)					
A	8' - 10' deep	1500	L.F.	30.00	45,000.00	
B	Manholes 8' - 10' deep	3	EA	1,600.00	4,800.00	
	Total for NW7					\$49,800.00
NW8	6 & 12-inch PVC laterals to serve Expy. Heights					
A	12-inch 8' - 10' deep	3900	L.F.	30.00	117,000.00	
B	6-inch 4' - 6' deep	5600	L.F.	10.00	56,000.00	
C	Manholes 8' - 10' deep	7	EA	1,600.00	11,200.00	
D	Manholes 4' - 6' deep	12	EA	1,150.00	13,800.00	
	Total for NW8					\$198,000.00
NW9	Lift Station and Pressure Main on M 9 N (intersection of M 6 1/2 W)					
A	Lift Station Structure, Pumps etc.	1	LS	200,000.00	200,000.00	
B	6-inch Pressure Main on M 9 N (to M 6 W)	2600	L.F.	10.00	26,000.00	
C	Canal Crossing	1	LS	20,000.00	20,000.00	One crossing
	Total for NW9					\$246,000.00
NW10	12-inch PVC on M 6 1/2 W (from M 9 N to M 9 1/2 N)					
A	10' - 12' deep	1300	L.F.	35.00	45,500.00	
B	8' - 10' deep	1300	L.F.	30.00	39,000.00	
C	Manholes 10' - 12' deep	3	EA	2,000.00	6,000.00	
D	Manholes 8' - 10' deep	3	EA	1,600.00	4,800.00	
	Total for NW10					\$95,300.00
NW11	8-inch PVC on M 9 N (from M 6 1/4 W to M 7 W)					
A	12' - 14' deep	1000	L.F.	35.00	35,000.00	
B	10' - 12' deep	1000	L.F.	30.00	30,000.00	
C	8' - 10' deep	6000	L.F.	25.00	150,000.00	
D	Manholes 12' - 14' deep	3	EA	2,475.00	7,425.00	
E	Manholes 10' - 12' deep	2	EA	2,000.00	4,000.00	
F	Manholes 8' - 10' deep	1	EA	1,600.00	1,600.00	
	Total for NW11					\$228,025.00

Table 3.5 (Continued..)

**WASTEWATER COLLECTION SYSTEM
PROPOSED IMPROVEMENTS**

Northwest Quadrant (Continued..)

Item	Item Description	Quantity	Units	Unit Cost (\$)	Item Cost (\$)	Remarks/ Total Cost
NW12	6 & 8-inch PVC laterals to serve Colonia Del Noresta					
A	8-inch 8' - 10' deep	1300	L.F.	25.00	32,500.00	
B	6-inch 6' - 8' deep	10200	L.F.	12.00	122,400.00	
C	Manholes 8' - 10' deep	2	EA	1,600.00	3,200.00	
D	Manholes 6' - 8' deep	16	EA	1,350.00	21,600.00	
	Total for NW12					\$179,700.00
NW13	6 & 8-inch PVC laterals in Delta Courts Subd. & Vicinity					
A	8-inch 8' - 10' deep	1400	L.F.	25.00	35,000.00	
B	6-inch 6' - 8' deep	6300	L.F.	12.00	75,600.00	
C	Manholes 8' - 10' deep	4	EA	1,600.00	6,400.00	
D	Manholes 6' - 8' deep	14	EA	1,350.00	18,900.00	
	Total for NW13					\$135,900.00
NW14	6 & 8-inch PVC laterals in Chapa Subdivision					
A	8-inch 6' - 8' deep	900	L.F.	20.00	18,000.00	
B	6-inch 4' - 6' deep	1500	L.F.	10.00	15,000.00	
C	Manholes 6' - 8' deep	2	EA	1,350.00	2,700.00	
D	Manholes 4' - 6' deep	3	EA	1,150.00	3,450.00	
	Total for NW14					\$39,150.00
NW15	10-inch PVC from SE of Cleckler School to M 5 3/4 W					
A	8' - 10' deep	2200	L.F.	25.00	55,000.00	
B	Manholes 8' - 10' deep	5	EA	1,600.00	8,000.00	
	Total for NW15					\$63,000.00
NW16	15-inch PVC on M 6 1/2 W (from Hwy. 83 to M 7 N)					
A	12' - 14' deep	3000	L.F.	45.00	135,000.00	
B	Manholes 12' - 14' deep	6	EA	2,500.00	15,000.00	
	Total for NW16					\$150,000.00
NW17	12-inch PVC on M 7 N (from M 7 W to M 6 1/2 W)					
A	6' - 8' deep	2400	L.F.	25.00	60,000.00	
B	Manholes 6' - 8' deep	5	EA	1,350.00	6,750.00	
	Total for NW17					\$66,750.00

Table 3.5 (Continued..)

WASTEWATER COLLECTION SYSTEM
PROPOSED IMPROVEMENTS

Northwest Quadrant (Continued..)

Item	Item Description	Quantity	Units	Unit Cost (\$)	Item Cost (\$)	Remarks/ Total Cost
NW18	8-inch PVC laterals in Midway Village					
A	4' - 6' deep	2600	L.F.	16.00	41,600.00	
B	Manholes 4' - 6' deep	6	EA	1,150.00	6,900.00	
	Total for NW18					\$48,500.00
NW19	8-inch PVC laterals in Rosedale Heights Subd.					
A	4' - 6' deep	1350	L.F.	16.00	21,600.00	
B	Manholes 4' - 6' deep	3	EA	1,150.00	3,450.00	
	Total for NW19					\$25,050.00
NW20	6-inch PVC laterels serving High Point Subd.					
A	6' - 8' deep	1800	L.F.	12.00	21,600.00	
B	Manholes 6' - 8' deep	2	EA	1,350.00	2,700.00	
	Total for NW20					\$24,300.00
NW21	12-inch on M 8 1/2 N to serve Flora Subd.					
A	8' - 10' deep	1300	L.F.	30.00	39,000.00	
B	Manholes 8' - 10' deep	5	EA	1,600.00	8,000.00	
	Total for NW21					\$47,000.00
NW22	6-inch PVC laterals in Flora Subd.					
A	6' - 8' deep	5400	L.F.	12.00	64,800.00	
B	Manholes 6' - 8' deep	9	EA	1,350.00	12,150.00	
	Total for NW22					\$76,950.00
NW23	Lift Station, 15-inch Gravity Line and 6-inch Pressure Main at Milano Dr. & Hwy. 83					
A		1	LS	299,793.00	299,793.00	Based on the least bidder. City is currently in the process of awarding the contract.
	Total for NW23					\$299,793.00

TOTAL COST FOR NORTHWEST QUADRANT IMPROVEMENTS: \$2,474,118.00

Table 3.6

Cost Estimate for Rehabilitation of Existing Lift Stations

Lift Station #	Rehab Item	Quantity	Units	Cost	Remarks/Total Cost
LS 1	Rehab Roof of Bldg..	1	LS	\$2,790.00	
	Replace Electrical	1	LS	\$10,650.00	
	Replace Pump # 2	1	LS	\$6,000.00	
	Total for Lift Station # 1				
LS 2	Installation of door, frame & paint	1	LS	\$900.00	
	Resurfacing of Wet Well	1	LS	\$42,800.00	
	Replace Motors	1	LS	\$3,500.00	
	Replace Pumps	1	LS	\$10,000.00	
	Replace Valves	1	LS	\$1,200.00	
	Replace Drive Shafts	1	LS	\$800.00	
	Sand blast & paint - pumps & pipes	1	LS	\$800.00	
	Total for Lift Station # 2				
LS 3	Paint Building	1	LS	\$500.00	
	Coat Wet Well	1	LS	\$39,350.00	
	Upgrade electrical System	1	LS	\$1,000.00	
	Replace Pumps	1	LS	\$8,000.00	
	Replace Drive Shafts	1	LS	\$350.00	
	Sand blast & paint - pumps & pipes	1	LS	\$800.00	
	Total for Lift Station # 3				
LS 4	Replace bldg.				Break down of cost not available at this time.
	Rehab Wet Well				
	Replace Electrical				
	Replace Pumps				
	Replace Valves				
	Replace Drive Shafts				
	Sand blast & paint - pumps & pipes				
Total for Lift Station # 4	1	LS		\$100,000.00	
LS 5	Install Fence				Break down of cost not available at this time.
	Rehab Wet Well				
	Replace Electrical				
	Replace Pump # 2				
	Replace Drive Shafts				
	Sand blast & paint - pumps & pipes				
	Total for Lift Station # 5	1	LS		
LS 6	Paint Bldg.	1	LS	\$500.00	
	Total for Lift Station # 6				

Table 3.6 (Continued..)

Cost Estimate for Rehabilitation of Existing Lift Stations

Lift Station #	Rehab Item	Quantity	Units	Cost	Remarks/Total Cost
LS 9	Repair Fence	1	LS	\$450.00	
	Replace Metal Sheet Bldg.	1	LS	\$7,850.00	
	Replace Electrical	1	LS	\$10,200.00	
	Replace Valves	1	LS	\$800.00	
	Replace Drive Shafts	1	LS	\$650.00	
	Sand blast & paint - pumps & pipes	1	LS	\$500.00	
	Total for Lift Station # 9				
LS 10	Paint and install new doors (bldg.)	1	LS	\$1,700.00	
	Replace Drive Shafts (One)	1	LS	\$300.00	
	Total for Lift Station # 10				\$2,000.00
LS 11	Replace Fence	1	LS	\$2,000.00	
	Resurface Wet Well	1	LS	\$25,000.00	
	Total for Lift Station # 11				\$27,000.00
LS 12	Replace bldg.	1	LS	\$8,750.00	
	Replace Electrical	1	LS	\$10,979.00	
	Replace Valves	1	LS	\$600.00	
	Sand blast & paint - pumps & pipes	1	LS	\$671.00	
	Total for Lift Station # 12				\$21,000.00
LS 13	Repair Fence	1	LS	\$1,000.00	
	Sand blast & paint - pumps & pipes	1	LS	\$500.00	
	Total for Lift Station # 13				\$1,500.00
LS 16	Replace Valves	1	LS	\$800.00	
	Replace Fiberglass Cover	1	LS	\$1,200.00	
	Total for Lift Station # 16				\$2,000.00
LS 17	Install Bldg., rehab Wet well, Replace electrical, piping, valves etc.				Break down of items not available at this time
	Total for Lift Station # 17	1	LS		\$75,000.00
LS 18	Repair Fence	1	LS	\$300.00	
	Replace Pump	1	LS	\$4,000.00	
	Replace Valves	1	LS	\$800.00	
	Total for Lift Station # 18				\$5,100.00

Table 3.6 (Continued..)

Cost Estimate for Rehabilitation of Existing Lift Stations

Lift Station #	Rehab Item	Quantity	Units	Cost	Remarks/Total Cost
LS 20	Replace Fiberglass Covers	1	LS	\$1,800.00	
	Total for Lift Station # 20				\$1,800.00
LS 21	Rebuild Pumps	1	LS	\$1,200.00	
	Replace Valves	1	LS	\$800.00	
	Sand Balst & Paint	1	LS	\$500.00	
Total for Lift Station # 21				\$2,500.00	
LS 22	Replace Pumps	1	LS	\$3,800.00	
	Replace Fiberglass Covers	1	LS	\$1,200.00	
Total for Lift Station # 22				\$5,000.00	
LS 23	Replace Pumps	1	LS	\$4,200.00	
	Replace Valves	1	LS	\$800.00	
Total for Lift Station # 23				\$5,000.00	
LS 24	Replace Valves	1	LS	\$500.00	
	Sand blast & paint - pumps & pipes	1	LS	\$500.00	
Total for Lift Station # 24				\$1,000.00	

TOTAL COST FOR LIFT STATIONS REHABILITATION:	\$519,290.00
---	---------------------

CHAPTER 4

PROJECT SCHEDULE & IMPLEMENTATION PLAN

1. Implementation Plan

A. Five Year Schedule of System Improvements

This section presents a preliminary schedule for implementing the proposed improvements. It is to be noted that various factors, namely, availability of funds, growth pattern, etc., influence the sequence of the schedule. However, an attempt is made to prioritize the improvements based on the best engineering judgement and on consulting with the City. Table 4.1 shows the breakdown of the improvements and the cost estimates.

Priority was assigned based on the current and future requirements. Top most priority was given to provide sewer services to the areas that are currently within the City limits.

B. Potential Funding Sources

a) State Support (If eligible)

1. Economically Distressed Areas Program (EDAP) (TWDB)

EDAP funds water and wastewater treatment works, water distribution and wastewater collection systems and a "T connection" or stub-out at the property line. At the end of the Phase I study, the political subdivision applies for funding for plans and specifications and construction. Funds are in the form of a grant and loan combination. No rigid formula determines funding. The Texas Water Development Board and staff essentially negotiate each project on a case-by-case basis. The program will not fund laterals on private property. The program does not fund hook-up or connection fees. The program can fund on-site systems, but no on-site system have been funded to date through EDAP.

As it can be seen from Figure 2.6, some of the colonias are included within the 2010 land use boundary. It is suggested that the City submit an application to TWDB requesting funds to serve these colonias, if determined eligible. The following is a list of potential eligible colonias:

Chapa Subdivision
Mid-Valley Estates
Colonia Del Noresta
Delta Courts
Expressway Heights Subdivision
Flore Subdivision
Sun Country Estates

Mid Valley Village
Rosedale Heights
La Loma Alta Subdivision
La Palma Subdivision.

2. Community Development Fund (Texas Department of Housing and Community Affairs (TDHCA)
This grant program funds water and sewer projects as well as other public infrastructure improvements, such as, street paving and drainage improvements. There is an annual funding cycle, i.e. deadlines to apply every year. Projects are ranked and funded in priority order. Projects rarely exceed \$300,000. These funds are allocated through the local Urban County Program.

3. Colonia Fund

This program funds water and sewer service laterals and connections in colonias located within 150 miles of the Texas-Mexico border. Funding is 100% grant. A political subdivision is limited to a maximum grant of \$500,000. Funds are awarded on a competitive basis. Some funds are available for related activities for colonias. A drainage and street improvement plan is the type of activity that might also be eligible for funding.

b) Local Funding

At this time, no local funds are available for implementation of the project. When it is required, it is assumed that the City may apply for loan funds from the State (like SRF), or will sell revenue bonds. It is suggested that the City implement a rate study to determine the actual increase in cost per connection, if any, to implement the proposed improvements..

c) User Fees

The City currently charges a fixed monthly wastewater fee to its customers for the twelve month period March through February. The volume of wastewater to which the fixed fee is charged is based on 80% of the customers average winter months water usage (January through March). City Ordinance No. 96-03 that prescribes the sewer rates is included in the appendix.

Table 4.1

Priority Schedule of the Proposed Improvements
City of Weslaco

Year 1996 - 1997

Item	Item Description	Location	Cost (Current Year) (1996)	Cost (Project Year)	Remarks/Line No.
1	12-inch PVC on M 6 1/2 W (from M 7 N to M 6 3/4 N)	Southwest	\$58,500.00	\$58,500.00	SW6
2	12-inch OVC to serve La Palma Subd.	Southwest	\$37,900.00	\$37,900.00	SW7
3	8 & 10-inch laterals in La Palma Subd.	Southwest	\$109,200.00	\$109,200.00	SW8
4	15-inch PVC on M 6 N (from LS on SW of Sunvalley to M6W)	Southwest	\$158,900.00	\$158,900.00	SW12
5	12-inch on M 6 W (from M 6 N to M 6 3/4 N)	Southwest	\$133,100.00	\$133,100.00	SW13
6	12-inch PVC on M 6 W to serve Westgate and surrounding	Southwest	\$22,750.00	\$22,750.00	SW17
7	6 & 8-inch laterals in Citrus Retreat Subd.	Southwest	\$137,800.00	\$137,800.00	SW18
8	8-inch PVC on M 5 1/2 W (from M 6 N to canal)	Southwest	\$14,300.00	\$14,300.00	SW19
9	15-inch PVC on M 3 W (from LS at 1015 RV Park to M 6 1/2 N)	Southeast	\$38,200.00	\$38,200.00	SE4
10	15-inch PVC on M 6 1/2 N (to serve South Palm Gardens)	Southeast	\$53,800.00	\$53,800.00	SE5
11	8 & 10-inch PVC laterals in South Palm Gardens	Southeast	\$24,150.00	\$24,150.00	SE6
12	6-inch PVC Pressure Main (from LS at 1015 RV to Hwy. 83)	Southeast	\$33,000.00	\$33,000.00	SE7
13	8 & 12 -inch to serve Kaymar Subd.	Southeast	\$55,500.00	\$55,500.00	SE9
14	12-inch PVC on M 3 1/2 W (from Expy. to M 7 N)	Northeast	\$124,900.00	\$124,900.00	NE1
15	12-inch PVC on M 4 W (from M 7 3/4 N to M 7 1/2 N)	Northeast	\$46,800.00	\$46,800.00	NE2
16	Lift Station & Pressure Main on M 4 1/2 W (Near M 10 N)	Northeast	\$282,400.00	\$282,400.00	NE5
17	12-inch on M 10 N (from M 4 1/2 W to M 5 W)	Northeast	\$116,375.00	\$116,375.00	NE8
18	12-inch on M 5 W (from M 10 N to M 9 1/4 N)	Northeast	\$132,800.00	\$132,800.00	NE9
19	12-inch on M 8 N (from M 3 1/2 W to M 3 W)	Northeast	\$71,750.00	\$71,750.00	NE10
20	12-inch PVC on M 9 1/2 N (from M 5 W o M 5 1/2 W)	Northwest	\$86,000.00	\$86,000.00	NW3
21	8-inch PVC to serve San Fransisco Subd.	Northwest	\$45,000.00	\$45,000.00	NW4
22	12-inch PVC on M 9 N to serve Sun Country Ests.	Northwest	\$19,800.00	\$19,800.00	NW5
23	6 & 8-inch laterals to serve Sun Country Ests.	Northwest	\$69,800.00	\$69,800.00	NW6
24	12-inch PVC on M 6 1/2 W (from LS to M 8 1/2 N)	Northwest	\$49,800.00	\$49,800.00	NW7
25	6 & 12-inch PVC laterals to serve Expy. Heights	Northwest	\$198,000.00	\$198,000.00	NW8
26	10-inch PVC from SE of Cleckler School to M 5 3/4 W	Northwest	\$63,000.00	\$63,000.00	NW15
27	15-inch PVC on M 6 1/2 W (from Hwy. 83 to M 7 N)	Northwest	\$150,000.00	\$150,000.00	NW16
28	12-inch PVC on M 7 N (from M 7 W to M 6 1/2 W)	Northwest	\$66,750.00	\$66,750.00	NW17
29	Lift Station at Milano Drive.	Northwest	\$299,793.00	\$299,793.00	NW23
30	Rehabilitation of Lift Station No. 9		\$20,450.00	\$20,450.00	LS 9
31	Odor Control at Lift Station No. 5		\$60,000.00	\$60,000.00	
32	Odor Control at Lift Station No. 10		\$75,000.00	\$75,000.00	
	Subtotal		\$2,855,518.00	\$2,855,518.00	
	Contingency (15%)		\$428,327.70	\$428,327.70	
	Engineering (7%)		\$199,886.26	\$199,886.26	
	TOTAL IMPROVEMENTS FOR 1996-97		\$3,483,731.96	\$3,483,731.96	

Table 4.1 (Continued..)

Priority Schedule of the Proposed Improvements
City of Weslaco

Year 1997 - 1998

Item	Item Description	Location	Cost (Current Year) (1996)	Cost (Project Year)	Remarks/Line No.
1	18-inch PVC on M 5 1/2 W (from M 6 N to M 5 1/2 N)	Southwest	\$235,000.00	\$242,050.00	SW9
2	12-inch PVC on M 5 1/2 W (from M 5 1/2 N to Quail Hollow)	Southwest	\$86,000.00	\$88,580.00	SW10
3	6-inch PVC pressure main (from LS of Sun Valley to M 5 1/2W)	Southwest	\$17,000.00	\$17,510.00	SW11
4	12-inch on M 5 1/4 N (to serve Westgate etc.)	Southwest	\$91,000.00	\$93,730.00	SW14
5	12-inch on Woodland Dr. (to serve Westgate)	Southwest	\$89,000.00	\$91,670.00	SW15
6	8 & 10-inch laterals in Westgate woods	Southwest	\$106,200.00	\$109,386.00	SW16
7	Lift Station & Pressure Main on M 9 N (at M 6 1/2 W)	Northwest	\$246,000.00	\$253,380.00	NW9
8	12-inch on M 6 1/2 W (from M 9 N to M 9 1/2 N)	Northwest	\$95,300.00	\$98,159.00	NW10
9	8-inch PVC on M 9 N (from M 6 1/4 W to M 7 W)	Northwest	\$228,025.00	\$234,865.75	NW11
10	6 & 8-inch laterals to serve Colonia Del Noresta	Northwest	\$179,700.00	\$185,091.00	NW12
11	6 & 8-inch laterals in Delta Courts & Vicinity	Northwest	\$135,900.00	\$139,977.00	NW13
12	6 & 8-inch laterals to serve Chapa Subd.	Northwest	\$39,150.00	\$40,324.50	NW14
13	6-inch laterals in High Point Subd.	Northwest	\$24,300.00	\$25,029.00	NW20
14	12-inch on M 8 1/2 N to serve Flora Subd.	Northwest	\$47,000.00	\$48,410.00	NW21
15	6-inch laterals in Flora Subd.	Northwest	\$76,950.00	\$79,258.50	NW22
16	Rehabilitation of all Lift Stations (except No. 9)		\$498,840.00	\$513,805.20	
17	Odor Control at Lift Station No. 5		\$60,000.00	\$61,800.00	
18	Odor Control at Lift Station No. 10		\$75,000.00	\$77,250.00	
	Subtotal		\$2,330,365.00	\$2,400,275.95	
	Contingency (15%)		\$349,554.75	\$360,041.39	
	Engineering (7%)		\$163,125.55	\$168,019.32	
	TOTAL IMPROVEMENTS FOR 1997-98		\$2,843,045.30	\$2,928,336.66	

Table 4.1 (Continued..)

Priority Schedule of the Proposed Improvements
City of Weslaco

Year 1998 - 1999

Item	Item Description	Location	Cost (Current Year) (1998)	Cost (Project Year)	Remarks/Line No.
1	15-inch on M 6 1/2 W (from M 6 N to M 6 1/2 N)	Southwest	\$182,000.00	\$193,083.80	SW2
2	12-inch on M 6 N (from M 6 1/2 W to M 7 W)	Southwest	\$122,825.00	\$130,305.04	SW3
3	10-inch on M 7 W (to serve Alamo Alta Subd.)	Southwest	\$53,000.00	\$56,227.70	SW4
4	8-inch laterals in Alamo Alta Subd.	Southwest	\$84,600.00	\$89,752.14	SW5
5	15-inch on M 5 N (from M 3 1/2 W to M 3 W)	Southeast	\$103,300.00	\$109,590.97	SE1
6	15-inch PVC on M 3 W (from M 5 N to M 5 1/2 N)	Southeast	\$128,000.00	\$135,795.20	SE2
7	6-inch PVC pressure main (from LS at Siesta Vil. to M 3 W)	Southeast	\$7,000.00	\$7,426.30	SE3
8	12-inch on M 5 1/2 N (from Drain Ditch to M 3 1/2 W)	Southeast	\$91,000.00	\$96,541.90	SE8
9	8-inch laterals in Midway Village	Northwest	\$48,500.00	\$51,453.65	NW18
10	8-inch laterals in Rosedale Heights.	Northwest	\$25,050.00	\$26,575.55	NW19
11	Odor Control at Lift Station No. 5		\$60,000.00	\$63,654.00	
12	Odor Control at Lift Station No. 10		\$75,000.00	\$79,567.50	
	Subtotal		\$980,275.00	\$1,039,973.75	
	Contingency (15%)		\$147,041.25	\$155,996.06	
	Engineering (7%)		\$68,619.25	\$72,798.16	
	TOTAL IMPROVEMENTS FOR 1998-99		\$1,195,935.50	\$1,268,767.97	

Table 4.1 (Continued..)

Priority Schedule of the Proposed Improvements
City of Weslaco

Year 1999-2000

Item	Item Description	Location	Cost (Current Year) (1996)	Cost (Project Year)	Remarks/Line No.
1	8-inch PVC on M 2 1/2 W (from M 9 N to M 8 1/2 N)	Northeast	\$70,000.00	\$76,490.89	NE3
2	8-inch PVC on M 3 W (from M 9 1/4 N to M 9 N)	Northeast	\$45,000.00	\$49,172.72	NE4
3	Odor Control at Lift Station No. 5		\$60,000.00	\$65,563.62	
4	Odor Control at Lift Station No. 10		\$75,000.00	\$81,954.53	
	Subtotal		\$250,000.00	\$273,181.75	
	Contingency (15%)		\$37,500.00	\$40,977.26	
	Engineering (7%)		\$17,500.00	\$19,122.72	
	TOTAL IMPROVEMENTS FOR 1999-2000		\$305,000.00	\$333,281.74	

APPENDICES

Table 4.1 (Continued..)

Priority Schedule of the Proposed Improvements
City of Weslaco

Year 2000-2001

Item	Item Description	Location	Cost (Current Year) (1996)	Cost (Project Year)	Remarks
1	8-inch PVC on M 4 1/2 W (to serve Mid Valley Ests.)	Northeast	\$32,950.00	\$37,085.52	NE6
2	6 & 8-inch laterals in Mid Valley Ests.	Northeast	\$38,500.00	\$43,332.09	NE7
3	12-inch PVC on M 10 N (from M 5 W to M 6 W)	Northwest	\$204,000.00	\$229,603.80	NW1
4	8 & 10-inch laterals to serve Country Aire Ests.	Northwest	\$76,300.00	\$85,876.32	NW2
5	Odor Control at Lift Station No. 5		\$60,000.00	\$67,530.53	
6	Odor Control at Lift Station No. 10		\$75,000.00	\$84,413.16	
7	Engg. Study to determine the need of plant upgrade/addition	North & South	\$75,000.00	\$75,000.00	
	Subtotal		\$561,750.00	\$632,254.57	
	Contingency (15%)		\$84,262.50	\$94,838.19	
	Engineering (7%)		\$39,322.50	\$44,257.82	
	TOTAL IMPROVEMENTS FOR 2000-2001		\$685,335.00	\$771,350.58	

2001 & Beyond

Item	Item Description	Location	Cost (Current Year) (1996)	Cost (Project Year)	Remarks
1	1.0 MGD Upgrade to Trickling Filters	North Plant	\$1,000,000.00		If required.
2	1.25 MGD Addition to the South Plant	South Plant	\$1,800,000.00		If required.
	Subtotal		\$2,800,000.00		Cost not pro-rated
	Contingency (15%)		\$420,000.00		for the year of
	Engineering (7%)		\$196,000.00		implementation.
	TOTAL IMPROVEMENTS BEYOND 2001		\$3,416,000.00		

Notes:

Cost for Project Year is estimated by considering a 3% inflation rate per year.

CHAPTER 5

CONCLUSIONS

The existing wastewater treatment and collection systems of the City of Weslaco were evaluated for current and future conditions. It was found that the existing 2.0 MGD North plant will be able to serve the City until year 2001, and the 1.25 MGD South plant will serve until 2007. However, a detailed Engineering Study is recommended in the Year 2000 to evaluate the population growth rate and to determine the necessity of additional treatment capacity. The study should include both the North and the South Plants.

Gravity lines along with three lift stations and pressure mains are proposed to serve the present and future growth areas of the City of Weslaco. A cost estimate along with a detailed map showing the proposed improvements are included in the report.

Finally, this report is intended for discussions and study purposes only. The existing conditions shown in the report might vary and should be determined and established for design and construction purposes.

WASTEWATER DISCHARGE PERMIT
(ONLY FEW RELEVANT PAGES INCLUDED IN THIS REPORT. PLEASE CONSULT
THE CITY FOR A COMPLETE COPY OF THE PERMIT)



PERMIT NO. 10619-003
(corresponds to
NPDES PERMIT NO. TX0)

TEXAS NATURAL RESOURCE CONSERVATION COMMISSION
P.O. Box 13087
Austin, Texas 78711-3087

PERMIT TO DISPOSE OF WASTES
under provisions of Chapter 26
of the Texas Water Code

City of Weslaco

whose mailing address is

500 South Kansas
Weslaco, Texas 78596

is authorized to treat and dispose of wastes from the Weslaco Wastewater Treatment Plant

located northeast of the City of Weslaco approximately 4,000 feet east of State Highway 88 and approximately 4,000 feet north of Pike Boulevard in Hidalgo County, Texas

to an unnamed drainage ditch; thence to the North Floodway; thence to the Laguna Madre in Segment No. 2491 of the Bays and Estuaries

only in accordance with effluent limitations, monitoring requirements and other conditions set forth herein, as well as the rules of the Texas Natural Resource Conservation Commission ("Commission"), the laws of the State of Texas, and other orders of the Commission. The issuance of this permit does not grant to the permittee the right to use private or public property for conveyance of wastewater along the herein described discharge route. This includes property belonging to but not limited to any individual, partnership, corporation or other entity. Neither does this permit authorize any invasion of personal rights nor any violation of federal, state, or local laws or regulations. It is the responsibility of the permittee to acquire property rights as may be necessary to use the herein described discharge route.

This permit and the authorization contained herein shall expire at midnight, five years after the date of Commission approval.

ISSUED DATE: **MAY 08 1995**

ATTEST:

A handwritten signature in cursive script, appearing to read "Anne J. McMaster", written over a horizontal line.

A handwritten signature in cursive script, appearing to read "Jan Gunn", written over a horizontal line.
For the Commission

INTERIM EFFLUENT LIMITATIONS AND MONITORING REQUIREMENTS

Outfall Number 001

1. During the period beginning upon the date of permit issuance and lasting through June 30, 1998, the permittee is authorized to discharge subject to the following effluent limitations:

The daily average flow of effluent shall not exceed 3.0 million gallons per day (MGD); nor shall the average discharge during any two-hour period (2-hour peak) exceed 3,125 gallons per minute (gpm).

Effluent Characteristic	Discharge Limitations				Minimum Self-Monitoring Requirements	
	Daily Avg mg/l (lbs/day)	7-day Avg mg/l	Daily Max mg/l	Single Grab mg/l	Report Daily Avg. & Daily Max. Measurement Frequency	Sample Type
Flow, MGD	Report	N/A	Report	N/A	Continuous	Totalizing meter
Biochemical Oxygen Demand (5-day)	20(500)	15	25	35	Two/week	Composite
Total Suspended Solids	20(500)	25	40	60	Two/week	Composite
Ammonia Nitrogen	Report(Report)	N/A	Report	N/A	Two/week	Composite

2. The effluent shall contain a chlorine residual of at least 1.0 mg/l after a detention time of at least 20 minutes (based on peak flow), and shall be monitored daily by grab sample. The permittee shall dechlorinate the chlorinated effluent to less than 0.1 mg/l chlorine residual and shall monitor daily by grab sample after the dechlorination process.
3. The pH shall not be less than 6.0 standard units nor greater than 9.0 standard units and shall be monitored once per week by grab sample.
4. There shall be no discharge of floating solids or visible foam in other than trace amounts and no discharge of visible oil.
5. Effluent monitoring samples shall be taken at the following location(s): Following the final treatment unit.
6. The effluent shall contain a minimum dissolved oxygen of 4 mg/l and shall be monitored twice per week by grab sample.

FINAL EFFLUENT LIMITATIONS AND MONITORING REQUIREMENTSOutfall Number 001

1. During the period beginning upon July 1, 1998 and lasting through the date of expiration, the permittee is authorized to discharge subject to the following effluent limitations:

The daily average flow of effluent shall not exceed 3.0 million gallons per day (MGD); nor shall the average discharge during any two-hour period (2-hour peak) exceed 3,125 gallons per minute (gpm).

<u>Effluent Characteristic</u>	<u>Discharge Limitations</u>				<u>Minimum Self-Monitoring Requirements</u>	
	Daily Avg mg/l(lbs/day)	7-day Avg mg/l	Daily Max mg/l	Single Grab mg/l	Report Daily Avg. & Daily Max. Measurement Frequency	Sample Type
Flow, MGD	Report	N/A	Report	N/A	Continuous	Totalizing meter
Carbonaceous Biochemical Oxygen Demand (5-day)	10(250)	15	25	35	Two/week	Composite
Total Suspended Solids	15(375)	25	40	60	Two/week	Composite
Ammonia Nitrogen	3(75)	6	10	15	Two/week	Composite

2. The effluent shall contain a chlorine residual of at least 1.0 mg/l after a detention time of at least 20 minutes (based on peak flow), and shall be monitored daily by grab sample. The permittee shall dechlorinate the chlorinated effluent to less than 0.1 mg/l chlorine residual and shall monitor daily by grab sample after the dechlorination process.
3. The pH shall not be less than 6.0 standard units nor greater than 9.0 standard units and shall be monitored once per week by grab sample.
4. There shall be no discharge of floating solids or visible foam in other than trace amounts and no discharge of visible oil.
5. Effluent monitoring samples shall be taken at the following location(s): Following the final treatment unit.
6. The effluent shall contain a minimum dissolved oxygen of 4 mg/l and shall be monitored twice per week by grab sample.

ORDINANCE 96-03

ORDINANCE NO. 96-03

AN ORDINANCE AMENDING SECTION I OF ORDINANCE 67-10, CODIFIED IN THE CITY OF WESLACO CODE OF ORDINANCES AS SECTION 29-43; ELIMINATING THE CALCULATIONS OF WASTEWATER CHARGES FOR COMMERCIAL LANDSCAPING; ELIMINATING THE BASIS FOR CALCULATIONS FOR WASTE WATER CHARGES ON NEW ACCOUNTS; PROVIDING FOR A SEPARATE CAPITAL IMPROVEMENT FACILITY FEE; PROVIDING FOR EFFECTIVE DATES; AND ORDAINING OTHER MATTERS WITH RESPECT TO THE SUBJECT MATTER HEREOF.

SECTION I: BE IT ORDAINED BY THE CITY COMMISSION OF THE CITY OF WESLACO, TEXAS, to amend Section I of Ordinance 67-10, adopted on June 27, 1967, and codified as Section 29-43 and entitled "Sewer Rates Prescribed", so that after Second and Final Reading of this Ordinance, Section 29-43, will read as follows:

ARTICLE II. SERVICE CHARGES

Sec. 29-43. Sewer Rates Prescribed.

The following rates shall be charged for use of the wastewater treatment facilities of the City of Weslaco, including storm sewer lines if used for the purpose of disposing waste or cooling water. The rates hereby established shall be applicable to all classes of customer using the city sanitary sewer system, except for industrial customers who will continue to be charged under the provisions of the industrial waste ordinance of the City of Weslaco, Ordinance 76-16, as amended:

- (1) Minimum charge. The minimum monthly charge for all classes of customers using the City of Weslaco wastewater treatment facilities shall be eight dollars (\$8.00) per month for those customers using three thousand (3,000) gallons of water or less per month; however, the charge will change to \$10.00 per month effective October 1, 1997.
- (2) Single-family residential. For those single family residential customers using more than three thousand and one (3,001) gallons of water per month, the charge for use of the City of Weslaco, wastewater treatment facility shall be fourteen dollars (\$14.00). The amount equal to fourteen dollars will be applied for each month when consumption is greater than three thousand (3,000) gallons of water; however, the charge will change to \$16.00 per month effective October 1, 1997.
- (3) Multi-family residential and mobile homes. The charge for the use of the City of Weslaco wastewater treatment facilities for duplexes for multi-family apartments or housing where the buildings are generally used solely for permanent or continuous living quarters and mobile home and/or recreational vehicle park owners using three thousand and one (3,001) or more gallons of water per month on master meters shall be eighty (80%) percent of each calendar month's water bill.
- (4) Commercial customers. For those commercial customers using three thousand and one (3,001) or more gallons of water per month, the charge for use of the City of Weslaco wastewater treatment facility shall be ninety-five (95%) percent of such customer's water bill during each calendar month. Commercial customers are those customers who discharge wastewater from a private building which is not residential in nature, as herein defined, conduct business activities for the sole purpose of making a profit, and receive an inflow of paying customers for services rendered or the purchase of goods. All sewer accounts required to file for a sales tax number with the Texas State Comptroller's Office or an employer's federal I.D. number with the Internal Revenue Service shall be deemed as commercial accounts.

- (5) Lawn irrigation. Taxing entities or any other accounts shall be exempt from sanitary sewer charges on water metered solely for lawn irrigation.
- (6) Industrial users. All industrial users, such as canning plants, packing sheds, laundries, bottling works, milk plants and other industrial users, shall be charged a rate computed under the Weslaco Industrial Waste Ordinance, codified as Article III of Chapter 29, Section 29-49, et seq., of the Weslaco Code of Ordinances.
- (7) Institutional, etc., users. All customers not classified above and using three thousand and one (3,001) gallons of water or more per month shall be charged for the use of the wastewater treatment facility eighty (80%) percent of the monthly bill. Customers in this class shall include institutional, religious and not-for-profit entities.
- (8) All classes of customers shall pay a "Capital Improvement Fee" per month until the Revenue Bonds for building the new sewer treatment facility are paid in full. The "Capital Improvement Fee" shall appear as a separate charge on customer's water bills. The Capital Improvement Fee for Single Family residential customers shall be five dollars and fifty-five cents (\$5.55) per month. All other classes of customers shall pay a monthly Capital Improvement Fee based on water consumption per month as follows:

0 - 10,000 gallons	\$12.50
10,001 - 50,000 gallons	\$25.00
50,001 + gallons	\$49.00

The Capital Improvement Fee shall be reviewed annually and adjusted if warranted. These rates will be effective June 1, 1996.

SECTION II.

These amendments to Chapter 29, Article II, Section 29-43, shall be in effect on June 1, 1996.

PASSED AND APPROVED on first reading at a regular meeting of the City Commission of the City of Weslaco on the 5th day of March, 1996.

PASSED AND APPROVED on second and final reading at a regular meeting by the City Commission of the City of Weslaco, Texas on the 16th day of April, 1996.

CITY OF WESLACO

MAYOR, GENE A. BRAUGHT

ATTEST:

CITY SECRETARY, AMANDA C. ELIZONDO

CITY ATTORNEY, RAMON VELA

**A 1996 CONSENSUS-BASED UPDATE TO THE
TEXAS WATER PLAN
CITY OF WESLACO POPULATION FORECAST**

PROJECTIONS OF POPULATION AND MUNICIPAL WATER USE
 WATER USE UNITS: ACRE-FEET

COUNTY: 108 HIDALGO

CITY: 638 WESLACO

SERIES	----- HISTORICAL -----		**----- PROJECTED -----**					
	1980	1990	2000	2010	2020	2030	2040	2050
Population	19331	21877						
Water Use	3653	3255						
MIGRATION RATE .0								
Population.....			25127	28500	31811	35268	38100	41159
Normal Rainfall			3575	4054	4525	5017	5420	5855
Below Normal Rainfall			4475	5076	5666	6281	6786	7331
Normal/Expected Conserv.			3378	3575	3741	4030	4225	4564
Below Normal/Expected Con			4250	4533	4775	5175	5463	5855
Normal/Advanced Conserv.			3237	3320	3456	3753	4012	4288
Below Normal/Advanced Con			4081	4214	4347	4780	5079	5440
(With Plumbing Code Only)								
Normal/Expected Conserv.			3434	3735	4027	4346	4566	4887
Below Normal/Expected Con			4334	4757	5167	5610	5932	6362
Normal/Advanced Conserv.			3378	3607	3884	4267	4524	4841
Below Normal/Advanced Con			4278	4629	5024	5531	5889	6316
MIGRATION RATE .5								
Population.....			27214	33506	40411	48834	56437	65224
Normal Rainfall			3871	4767	5749	6947	8029	9279
Below Normal Rainfall			4847	5968	7197	8697	10052	11617
Normal/Expected Conserv.			3628	4166	4708	5525	6259	7160
Below Normal/Expected Con			4573	5292	6020	7111	8092	9279
Normal/Advanced Conserv.			3506	3903	4346	5197	5942	6795
Below Normal/Advanced Con			4420	4917	5522	6564	7523	8621
(With Plumbing Code Only)								
Normal/Expected Conserv.			3719	4354	5070	5962	6701	7744
Below Normal/Expected Con			4694	5555	6518	7713	8724	10082
Normal/Advanced Conserv.			3628	4204	4934	5853	6701	7671
Below Normal/Advanced Con			4603	5405	6383	7603	8724	10009
MIGRATION RATE 1.0								
Population.....			29435	39115	50958	65408	80489	99047
Normal Rainfall			4187	5564	7249	9305	11450	14090
Below Normal Rainfall			5242	6966	9076	11649	14335	17641
Normal/Expected Conserv.			3924	4820	5879	7400	8926	10873
Below Normal/Expected Con			4946	6134	7535	9451	11450	14090
Normal/Advanced Conserv.			3792	4513	5480	6887	8385	10318
Below Normal/Advanced Con			4748	5740	6907	8792	10729	13092
(With Plumbing Code Only)								
Normal/Expected Conserv.			3990	5039	6336	7913	9557	11760
Below Normal/Expected Con			5045	6441	8162	10257	12442	15311
Normal/Advanced Conserv.			3924	4863	6165	7840	9557	11649
Below Normal/Advanced Con			4979	6265	7991	10184	12442	15200
MOST LIKELY SERIES								
Population.....			29435	36241	43710	52820	61044	70548
Normal Rainfall			4187	5156	6218	7514	8684	10036
Below Normal Rainfall			5242	6455	7785	9407	10872	12565
Normal/Expected Conserv.			3924	4506	5092	5976	6769	7744
Below Normal/Expected Con **			4946	5683	6512	7692	8752	10036
Normal/Advanced Conserv.			3792	4222	4700	5621	6359	7349
Below Normal/Advanced Con			4748	5318	5973	7100	8137	9325
(With Plumbing Code Only)								
Normal/Expected Conserv.			3990	4709	5435	6449	7248	8377
Below Normal/Expected Con			5045	6008	7001	8342	9436	10905
Normal/Advanced Conserv.			3924	4547	5337	6331	7248	8298
Below Normal/Advanced Con			4979	5846	6904	8224	9436	10826

**TWDB'S COMMENTS ON THE
DRAFT FINAL REPORT**



TEXAS WATER DEVELOPMENT BOARD

William B. Madden, *Chairman*
Charles W. Jenness, *Member*
Lynwood Sanders, *Member*

Craig D. Pedersen
Executive Administrator

Noé Fernández, *Vice-Chairman*
Elaine M. Barrón, M.D., *Member*
Charles L. Geren, *Member*

February 12, 1997

Mr. James Hiebert
Finance Director
City of Weslaco
500 South Kansas
Weslaco, Texas 78596

Re: Review of the Draft Final Report for the Regional Water Supply and Wastewater Planning Contract Between the City of Weslaco (City) and the Texas Water Development Board (TWDB), TWDB Contract No. 95-483-085

Dear Mr. Hiebert:

Texas Water Development Board staff have completed a review of the draft final report submitted under TWDB Contract No. 95-483-085. As stated in the above referenced contract, the City will consider incorporating comments on the draft final report from the TWDB, shown in Attachment 1, and other commentors into a final report. The City must include a copy of the TWDB's comments in the final report.

The Board looks forward to receiving one (1) unbound camera-ready original and nine (9) bound double-sided copies of the Final Report on this planning project. Please contact Mr. Gary Laneman, the Board's Contract Manager, at (512) 463-8062, if you have any questions about the Board's comments.

Sincerely,

A handwritten signature in cursive script, appearing to read "Tommy Knowles".

Tommy Knowles
Deputy Executive Administrator
for Planning

cc: Gary Laneman, TWDB

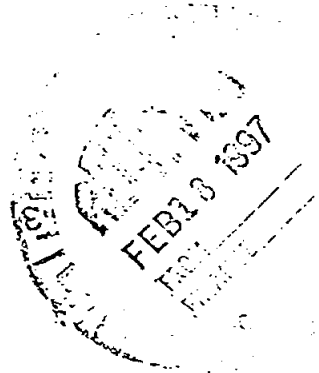

Our Mission

Exercise leadership in the conservation and responsible development of water resources for the benefit of the citizens, economy, and environment of Texas.

P.O. Box 13231 • 1700 N. Congress Avenue • Austin, Texas 78711-3231
Telephone (512) 463-7847 • Telefax (512) 475-2053 • 1-800-RELAY TX (for the hearing impaired)
URL Address: <http://www.twdb.state.tx.us> • E-Mail Address: info@twdb.state.tx.us

ATTACHMENT 1

TEXAS WATER DEVELOPMENT BOARD

COMMENTS ON THE CITY OF WESLACO'S REGIONAL WATER SUPPLY AND WASTEWATER PLANNING CONTRACT Contract No. 95-483-085

- 1) The consultant used the TWDB 1989 population projections for the City of Weslaco as the primary population projections for the study. In selecting the TWDB 1989 projections, the consultant reviewed the TWDB 1992 population projections and population projections prepared by Wilbur Smith Associates. TWDB has developed more recent 1994 population projections for the City of Weslaco that should be considered for the study. These new projections were used in developing the update to the State Water Plan in 1996. The 1994 population projections were developed through a consensus process with the Texas Natural Resource Conservation Commission and the Texas Parks and Wildlife Department and are more in line with the TWDB 1992 population projections.
- 2) The TWDB 1994 water requirement projections for Weslaco are lower than the water demands presented in the report due in part to the updated population projections, modified time series for developing planning per capita water use, and more detailed conservation information than was used in developing the previous 1990 projections. The official demands developed for the 1996 State Water Plan should be used for Weslaco.
- 3) The adequacy of cost estimates could not be determined due to lack of detail presented in the report on the development of cost estimates. Please include a more thorough documentation of how cost estimates were developed.
- 4) Different build-out rates were used in the report for water and wastewater. In order to be consistent, the use of the more conservative rate would be more appropriate.
- 5) The year in which a future analysis should be conducted is different for the new water plant and for an analysis of wastewater plant expansion. For continuity and simplicity, the same year should be recommended.
- 6) The estimated wastewater flow generated of 85 gpcpd, which came from a sample of flows generated from October, 1990 to October, 1991, does not contain within its makeup a water conservation component. Wastewater flows generated should be developed based on a systemwide per capita average demand of 150 gpcpd with a conservation component incorporated or a percentage of the demand having a water conservation component.

Regional Water Supply & Wastewater
For The
City Of Weslaco, Texas

Part 2 - Wastewater

Contract No. 95-483-085F

The following maps are not attached to this report. Due to their size, they could not be copied. They are located in the official file and may be copied upon request.

City of Weslaco, Texas -Wastewater Systeem

Figure 2.6

City of Weslaco,- Texas-Wastewater System
Existing System And Proposed Improvements

Please contact Research and Planning Fund Grants
Management Division at (512) 463-7926 for copies.