



May 21, 2011

Ms. Connie Townsend, P.E.  
Project Manager - Regions E, J, &M  
Water Resources Planning Division  
Texas Water Development Board  
1700 North Congress Ave.  
Austin, Texas 78701

*Re: Addendum to Final Regional Water Supply Facilities Plan Report - Hidalgo County, Texas  
TWDB Contact No. 0804830848*

Dear Ms. Townsend,

Submitted is the Addendum to the Final Regional Water Supply Facilities Plan Report, dated April 2011. The Addendum addresses TWDB's comments to the Final Report as outlined in an email and letter to Mr. Godfrey Garza, Jr., District Manager of Hidalgo County Drainage District No.1, dated April 29, 2011. This submittal includes the following items:

1. A hardcopy addendum with an original signed cover letter.
2. Six (6) printed copies of letter/addendum to be inserted in the preciously submitted Final Reports.
3. Six (6) CDs with complete deliverables: Final Report with this Addendum and April 4, 2011 Memorandum.

Sincerely,



Deren Li, Ph.D., P.E., D.WRE, CFM  
President

Enclosures

c: Godfrey Garza, Jr., District Manager of Hidalgo County Drainage District No.1

# Regional Water Supply Facilities Plan



prepared by



April 2011

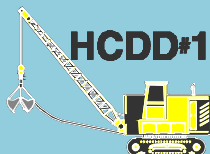

**ADDENDUM TO  
REGIONAL WATER SUPPLY FACILITIES PLAN  
FINAL REPORT (DATED APRIL 2011)**

To: Connie Townsend, P.E.  
From: Deren Li, PhD, P.E., D.WRE, CFM  
Date: May 20, 2011  
Re: Responses to TWDB Review Comments on Final Report of Regional Water Supply Facilities Plan (April 29, 2011)  
TWDB Contract No. 0804830848

---

The following responses are provided for the three (3) TWDB review comments for the Regional Water Supply Facilities Plan Final Report, dated April 2011. The comments were provided in an email from the Texas Water Development Board to Hidalgo County Drainage District No. 1 on April 29, 2011. For ease of review we have provided verbatim the comments in italics followed by our responses in normal font.

- 1. Comment: Page 1-3, column 2, last paragraph: The contract requires a third public meeting to occur between submittal of Draft Report and submittal of Final Report to take/consider public comments for the final report. In the addendum, please acknowledge that this meeting did not occur and provide reason.*

**Response:** A third public meeting was intended to be held after the water rights issue with TCEQ were resolved. Due to the time constraint of the project and the disagreement on the water issue between the Hidalgo County and TCEQ, it made it impossible to schedule the third public meeting before the contract deadline. The same attendees in the first and second public meetings are expected to attend the third public meeting. These attendees were well informed of the project development between the draft report and final report. The final report will be made available to all attendees that attended the first and second public meetings by the District.

- 2. Comment: Page 1-2, col.1/para.1 & col.2/para.4: No revisions were made for this comment, leaving the statement that the project area source water is only rainfall runoff and shallow groundwater. To my understanding this is not correct - there is a significant amount of farmland within the project area that is irrigated using water delivered by an irrigation district via irrigation canals and this water source is the Rio Grande. In the addendum, please revise and provide detailed information on the irrigation tailwater that enters the HCDD1 canal network.*

**Response:** There are two active irrigation water rights related to diversion of water from the Rio Grande River to the North Main Drain - Main Floodwater Channel watershed. They are WR No. 23-816 for Hidalgo County Irrigation District No.1 and WR No. 23-809 for Engleman Irrigation District, Delta Lake Irrigation District, and Alvaro & Ana,

FLP within the North Main Drain-Main Floodwater Channel watershed. The maximum amounts of water associated with these two water rights are 84,831.00 acre-feet and 19,044.35 acre-feet respectively. It is estimated that a total of 83,060.28 acre-feet water is diverted from the Rio Grande River into the North Main Drain - Main Floodwater Channel watershed, assuming an 80% of maximum water rights is utilized. Based on the irrigation practices in the area by consulting with the Hidalgo County Irrigation District No.1 and Engleman Irrigation District, a 5% irrigation tailwater is assumed. A total of 5,194 acre-feet of tailwater each year is estimated annually. It should be noted that the amount of tailwater into the drainage ditches is relatively small compared with stormwater runoff from the watershed and base flow from shallow groundwater discharges.

3. *Comment: Page 2-2, column 2, last paragraph: Only added 1 new paragraph to cover the entire Task 3. This new paragraph is still missing required information on what the permit process would be in the future if it is found that one is needed. Also to provide documentation of the discussions that have occurred with the TCEQ and current status.*

**Response:** To address the water rights issues related to this project, extensive communication and information exchange were conducted. Representatives from the HCDD#1 met with TCEQ representatives on August 9, 2010 in order to discuss the issues of whether or not a water rights permit would be required for this project. Following the meeting, series of investigations of the existing water rights permits within the watershed were performed to address TCEQ's concerns related to the understanding of state water law. At the time of this submission, there is still disagreement between TCEQ and Hidalgo County. Hidalgo County is of the opinion that the subject water is diffused water which is captured in a manmade drainage ditch system (not a natural water course) and Hidalgo County has the rights to develop the drainage water within the drainage system for beneficial uses. Hidalgo County believes a water rights permit is not required to develop the drainage water. Information on the additional HCDD#1 investigation resulting from the August 9, 2010 meeting and the TCEQ's subsequent review and determination are located in Appendix A of this Addendum. Of special note are emails August 10, 2010; August 20, 2010; September 2, 2010; and September 20, 2010.

However, if it is determined based on the Texas Water Law that a water rights permit is required, a water rights permit application with supporting data and documents will be prepared according to the water rights permit application procedures as outlined in the Form TCEQ-10214. This form is located in Appendix B of this Addendum.



## APPENDIX A

## Deren

---

**From:** Deren [dli@cseengineers.com]  
**Sent:** Thursday, April 15, 2010 11:45 AM  
**To:** 'Kellye Rila'  
**Cc:** 'Ronald L. Ellis'; 'connie.townsend@twdb.state.tx.us'; 'lora.briones'  
**Subject:** RE: Hidalgo Co. Drainage Water Development  
**Attachments:** Report2006.pdf; Need of the Project.pdf; DrainageAreaMap\_11x17\_jz.pdf

Kellye,

The attached map shows the drainage network within Hidalgo County Drainage District No.1 and the associated drainage area map. The purpose of this project is to develop drainage water collected by the Hidalgo County Drainage District drainage systems for beneficial uses. The three potential sites have been identified for the project. Also attached is the 2006 Report which was prepared to evaluate the availability of water within the drainage system. A Working Draft Report (2010) is being prepared to identify and evaluate alternative facility plans and is attached in a separate email.

As shown in the map, the drainage runoff drains toward the east through the Main Floodwater Channel and eventually outfall to the Laguna Madre Bay and the Gulf of Mexico.

Let me know if you need additional information. Thank you for your assistance on this project.

Sincerely,

*Deren Li, Ph.D., P.E., D.WRE, CFM*  
*Civil Systems Engineering Inc.*  
*9894 Bissonnet St., Suite 404*  
*Houston, Texas 77036*  
*713-298-6819 (c)*  
*713-782-3811 (o)*  
[www.cseengineers.com](http://www.cseengineers.com)

---

**From:** Kellye Rila [mailto:KRILA@tceq.state.tx.us]  
**Sent:** Wednesday, April 14, 2010 4:53 PM  
**To:** Deren  
**Cc:** Ronald L. Ellis  
**Subject:** Re: Hidalgo Co. Drainage Water Development

Deren:

To follow up on our telephone conversation of today, please send us some information with details on the project including a map and the source of the water. We can meet and discuss in more detail.

Kellye Rila

>>> "Deren" <[dli@cseengineers.com](mailto:dli@cseengineers.com)> 4/14/2010 11:06 AM >>>  
Good morning Ms. Rila,

As advised by Connie Townsend from TWDB, I am trying to contact you regarding development of drainage water within the Hidalgo County Drainage District No.1. drainage network. I have discussed this issue with your water rights specialists, Eria Harvey and Steve Ramos lately, and others last year. Based on my previous conversations, the water to be developed does not belong to the State and there are no permits required. To complete our existing Water Supply

Facilities Planning project, we need advice regarding the documentation required and your concurrence regarding this issue.

Please give me a call to further discuss this issue.

Sincerely,

*Deren Li, Ph.D., P.E., D.WRE, CFM*  
*Civil Systems Engineering Inc.*  
*9894 Bissonnet St., Suite 404*  
*Houston, Texas 77036*  
*713-298-6819 (c)*  
*713-782-3811 (o)*  
[www.cseengineers.com](http://www.cseengineers.com)



## Deren

---

**From:** Deren [dli@cseengineers.com]  
**Sent:** Thursday, April 15, 2010 12:02 PM  
**To:** 'Kellye Rila'  
**Cc:** 'Ronald L. Ellis'; 'connie.townsend@twdb.state.tx.us'; 'lora.briones'  
**Subject:** RE: Hidalgo Co. Drainage Water Development  
**Attachments:** Presentation121509\_HCWFP.pdf

Attached is the presentation given to Hidalgo County which provides important current project information regarding alternatives, water quality, cost estimates., etc. This presentation material provides better information than our working draft report at this stage.

*Deren Li, Ph.D., P.E., D.WRE, CFM*  
*Civil Systems Engineering Inc.*  
*9894 Bissonnet St., Suite 404*  
*Houston, Texas 77036*  
*713-298-6819 (c)*  
*713-782-3811 (o)*  
[www.cseengineers.com](http://www.cseengineers.com)

---

**From:** Kellye Rila [mailto:KRILA@tceq.state.tx.us]  
**Sent:** Wednesday, April 14, 2010 4:53 PM  
**To:** Deren  
**Cc:** Ronald L. Ellis  
**Subject:** Re: Hidalgo Co. Drainage Water Development

Deren:

To follow up on our telephone conversation of today, please send us some information with details on the project including a map and the source of the water. We can meet and discuss in more detail.

Kellye Rila

>>> "Deren" <[dli@cseengineers.com](mailto:dli@cseengineers.com)> 4/14/2010 11:06 AM >>>  
Good morning Ms. Rila,

As advised by Connie Townsend from TWDB, I am trying to contact you regarding development of drainage water within the Hidalgo County Drainage District No.1. drainage network. I have discussed this issue with your water rights specialists, Eria Harvey and Steve Ramos lately, and others last year. Based on my previous conversations, the water to be developed does not belong to the State and there are no permits required. To complete our existing Water Supply Facilities Planning project, we need advice regarding the documentation required and your concurrence regarding this issue.

Please give me a call to further discuss this issue.

Sincerely,

*Deren Li, Ph.D., P.E., D.WRE, CFM*  
*Civil Systems Engineering Inc.*  
*9894 Bissonnet St., Suite 404*  
*Houston, Texas 77036*  
*713-298-6819 (c)*



## Deren

---

**From:** Deren [dli@cseengineers.com]  
**Sent:** Tuesday, August 10, 2010 2:44 PM  
**To:** 'Kellye Rila'  
**Cc:** 'lbrookin@tceq.state.tx.us'; 'kalexand@tceq.state.tx.us'; 'Ronald L. Ellis'; 'hsetteme@tceq.state.tx.us'; 'Godfrey Garza'; 'scrain@atlashall.com'; 'Teague, Sharlotte'  
**Subject:** Water Rights for the Hidalgo County Water Facilities Plan  
**Attachments:** HC\_WR\_NM\_MFDC\_Watershed.JPG; HC\_5WaterRights.xls

Kellye,

Based on our meeting yesterday at TCEQ and the concerns of the existing water rights within the watershed for this project, we have further investigated the TCEQ water rights GIS database obtained from TCEQ previously. Based on the GIS database, there are five (5) water rights within the watershed. They are 12205396001, 12205396002, 12205396003, 62204523401 and 62204524401/62204524501, as shown in the attached Exhibit.

Based on the WRActive and WRInactive excel files (from TCEQ), we agree that there are two active water rights (62204523401 and 62204524401/62204524501) within the watershed. However, the source of both water rights is the Rio Grande River. As explained in the database, the locations of both water rights are used for storage purposes. The other three water rights 12205396001, 12205396002, and 12205396003 are not active. It should be noted that water rights 12205396002 and 12205396003 are probably incorrectly geocoded in the database since there are no Dry Creek or Colorado River within Hidalgo County. As shown in the WRInactive excel file, these two rights are located in Real and Travis Counties, respectively.

Hopefully this information will expedite TCEQ's decision-making process regarding this water rights issue.

If you have any questions or need additional information regarding this matter, please let me know.

Sincerely,

*Deren Li, Ph.D., P.E., D.WRE, CFM*  
*Civil Systems Engineering Inc.*  
*9894 Bissonnet St., Suite 404*  
*Houston, Texas 77036*  
*713-298-6819 (c)*  
*713-782-3811 (o)*  
[www.cseengineers.com](http://www.cseengineers.com)

wractive080410

WRNo	WRType	WRSeq	AppNo	WRIssueDate	AmendmentLetter	CancelledStatusCode	OwnerName	OwnerTypeCode	DivAmtValue
4523	6	1		10/1/1986			HIDALGO CO IRR DIST 1	2	
4524	6	1		10/1/1986			ENGLEMAN IRRIGATION DIST	2	254.5
5396	1	1	5396	6/16/1992		T	HANNIS T TURBERVILLE ET AL	4	2076
5396	2	0		12/16/1970		A	J H PLETCHER ET AL		35
5396	6	1		8/26/1988			STEVEN R BAKER	1	180

-  Active
-  Inactive

wractive080410

UseCode	PriorityDateMonth	PriorityDateDay	PriorityDateYear	PriorityClassCode	DateCancelled	ExpireRemarks
13	12	10	1973			
3	7	10	1928			
3	1	13	1992		5/6/2003	12/31/2002.APP TO RENEW WITHDRAWN 5/6/03
3	8	11	1969		3/14/1984	
3	11	12	1913			REVERTS BACK TO STEVEN R BAKER 1/16/2022

wractive080410

ConsumptiveAmt	Acreage	ResName	ResCap	SiteName	BasinCode	WMCode	RiverOrderNo	RegionCode	SWRACode	UnnamedTrib
	1200	STORE RIO GRANDE WATER	500			22 RG	8158250000	M		
			550			22 RG	8158000000	M		
	954					22 8156550000				DONNA DRAIN
	50		90			21 9085000000				DRY CREEK
	100					14 0565000000				COLORADO RIVI

StreamName	OtherStreamName	CountyName	Remarks	BaseWRNo	BaseWRType
NONE		Hidalgo	STORAGE OF RIO GRANDE WATER AUTHORIZED UNDER 23-816-6		
HC DD DRAIN		Hidalgo	2 RESERVOIRS. & STORAGE OF WATER AUTHORIZED UNDER 23-809-6		
	Hidalgo		EXPIRED 12/31/2002		
ER	Real				
	Travis		FROM BASTROP ENERGY PARTNERS LP TO BAKER		

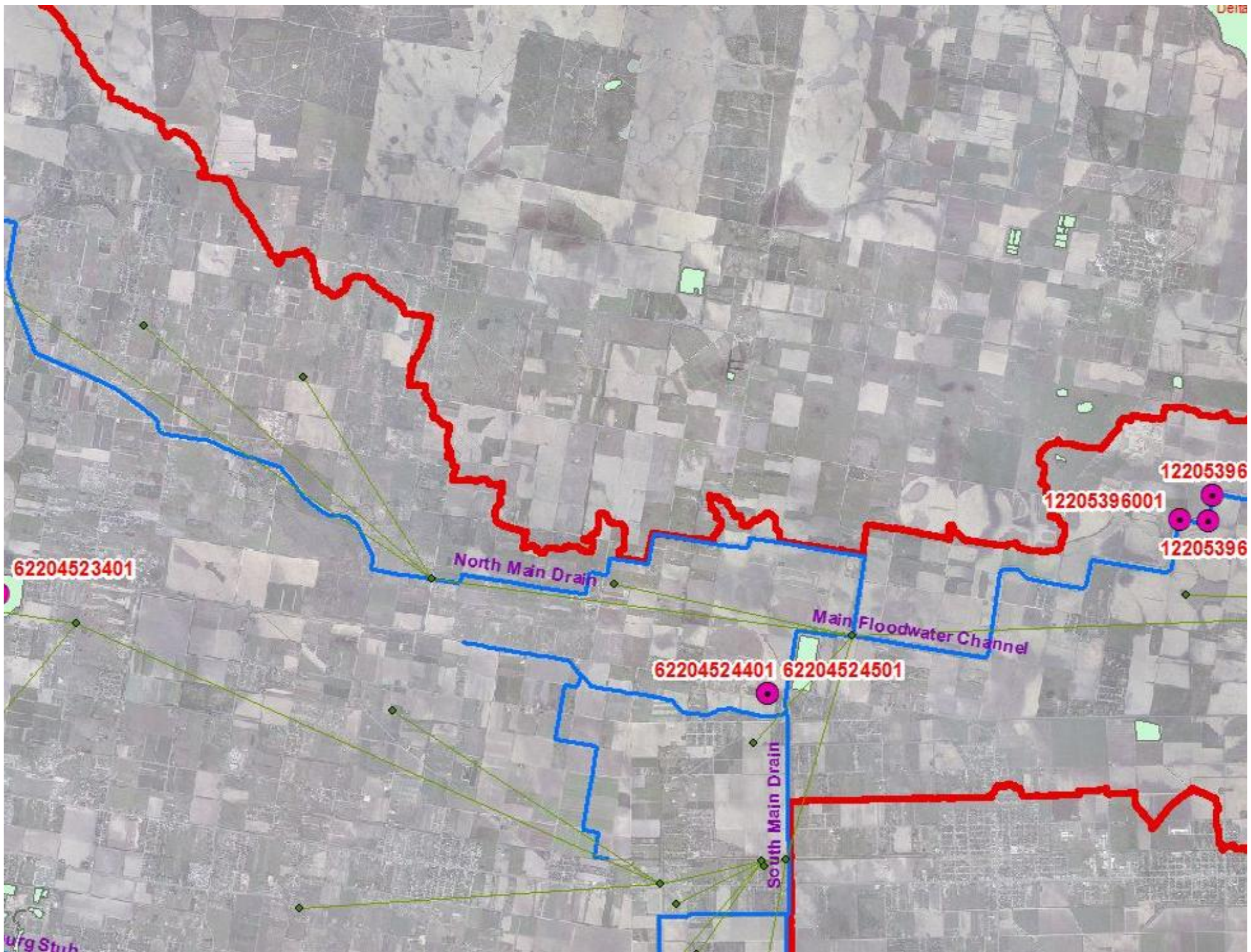



## Deren

---

**From:** Deren [dli@cseengineers.com]  
**Sent:** Monday, August 23, 2010 10:23 AM  
**To:** 'Kellye Rila'  
**Cc:** 'scrain@atlashall.com'; 'Godfrey Garza'; 'Sharlotte' 'Teague'; 'Arturo.Ballesteros@senate.state.tx.us'; 'Sean.Abbott@senate.state.tx.us'; 'Herman Settemeyer'; 'Jim Harrison'; 'Kathy Alexander'; 'Linda Brookins'; 'Ronald L. Ellis'; 'Robin Smith'  
**Subject:** RE: Water Rights for the Hidalgo County Water Facilities Plan

Kellye,

Thank you for the information.

Would you please email me the Map with pertinent features related to WR 22-4524 Certificate as stated in Section 5 - Special Conditions on Page 2 of the Certificate?

Thank you.

*Deren Li, Ph.D., P.E., D.WRE, CFM  
Civil Systems Engineering Inc.  
9894 Bissonnet St., Suite 404  
Houston, Texas 77036  
713-298-6819 (c)  
713-782-3811 (o)  
[www.cseengineers.com](http://www.cseengineers.com)*

---

**From:** Kellye Rila [mailto:KRILA@tceq.state.tx.us]  
**Sent:** Friday, August 20, 2010 3:32 PM  
**To:** Deren  
**Cc:** [scrain@atlashall.com](mailto:scrain@atlashall.com); 'Godfrey Garza'; 'Sharlotte' 'Teague'; [Arturo.Ballesteros@senate.state.tx.us](mailto:Arturo.Ballesteros@senate.state.tx.us); [Sean.Abbott@senate.state.tx.us](mailto:Sean.Abbott@senate.state.tx.us); Herman Settemeyer; Jim Harrison; Kathy Alexander; Linda Brookins; Ronald L. Ellis; Robin Smith  
**Subject:** Re: Water Rights for the Hidalgo County Water Facilities Plan  
**Importance:** High

Deren:

**Thank you for the additional information provided on August 10, 2010. Staff has researched information related to water rights in Hidalgo County in the Nueces Rio Grande Coastal Basin. During the Final Determination of Water Rights in the Nueces Rio Grande Coastal Basin, which was approved in court, a Certificate of Adjudication (22-4524) was granted to Hidalgo County Water Improvement District No. 6, which subsequently became the Engleman Irrigation District. In addition to authorizing diversion of water transferred from the Rio Grande Basin, the certificate authorizes diversion of 254.5 acre-feet of Nueces Rio Grande Coastal Basin water from the Hidalgo County Drainage District Drain. The Hidalgo County Drainage District Drain and the Donna Drain were determined to be watercourses in the certificate and were further designated as tributaries to the Laguna Madre. Therefore, staff believes a water rights permit would be required for diversion from this watercourse.**

With the exception of Certificate 22-4523, the remaining attached water rights authorize diversion of Nueces Rio Grande Coastal Basin water from flood control features, which were defined as watercourses in the adjudication and diversions would require a water rights permit.

There are potential options that might make some water available for diversion for your project in this area. We would be happy to meet with you to discuss these options further.

There are a number of TPDES permits authorizing discharge into drains, canals and other flood control features. The Texas Water Code (Chapter 26) requires an authorization to discharge sewage, and municipal, recreational, agricultural, or industrial waste into or adjacent to any water in the state.

If you have additional questions, please contact Kellye Rila at [krila@tceq.state.tx.us](mailto:krila@tceq.state.tx.us), or by phone at 512-239-4612. If you have questions about the GIS information, or need assistance for the ftp site, please contact Kathy Alexander at [kalexand@tceq.state.tx.us](mailto:kalexand@tceq.state.tx.us), or by phone at 512-239-0778.

Attached are the following documents:

Water Use Permits 5300 and 5045

Certificates of Adjudication 22-4520 to 22-4525.

Copy of the front matter from the Final Determination of Water Rights in the Nueces Rio Grande Coastal Basin.

Copy of the Final Determination for Certificate 22-4524

Copy of Texas Water Code §26.121

Copy of excerpt from 30 TAC §307.3 providing the definition of Surface water in the state

Due to technical issues involved with transmitting GIS data via email, the GIS information for water right locations and wastewater treatment plant outfalls within the boundary of the North Main Drain watershed are available at:

<ftp://ftp.tceq.state.tx.us/pub/WaterResourceManagement/WaterQuantity/GIS/HidalgoCounty/>

>>> "Deren" <[dli@cseengineers.com](mailto:dli@cseengineers.com)> 8/10/2010 2:44 PM >>>  
Kellye,

Based on our meeting yesterday at TCEQ and the concerns of the existing water rights within the watershed for this project, we have further investigated the TCEQ water rights GIS database obtained from TCEQ previously. Based on the GIS database, there are five (5) water rights within the watershed. They are 12205396001, 12205396002, 12205396003, 62204523401 and 62204524401/62204524501, as shown in the attached Exhibit.

Based on the WRActive and WRInactive excel files (from TCEQ), we agree that there are two active water rights (62204523401 and 62204524401/62204524501) within the watershed. However, the source of both water rights is the Rio Grande River. As explained in the database, the locations of both water rights are used for storage purposes. The other three water rights (12205396001, 12205396002, and 12205396003) are not active. It should be noted that water rights 12205396002 and 12205396003 are probably incorrectly geocoded in the database since there are no Dry Creek or Colorado River within Hidalgo County. As shown in the WRInactive excel file, these two rights are located in Real and Travis Counties, respectively.

Hopefully this information will expedite TCEQ's decision-making process regarding this water rights issue.

If you have any questions or need additional information regarding this matter, please let me know.

Sincerely,

*Deren Li, Ph.D., P.E., D.WRE, CFM  
Civil Systems Engineering Inc.  
9894 Bissonnet St., Suite 404  
Houston, Texas 77036  
713-298-6819 (c)  
713-782-3811 (o)  
[www.cseengineers.com](http://www.cseengineers.com)*

## Deren

---

**From:** Deren [dli@cseengineers.com]  
**Sent:** Wednesday, August 25, 2010 10:31 AM  
**To:** 'Kellye Rila'  
**Cc:** 'scrain@atlashall.com'; 'Godfrey Garza'; 'Sharlotte' 'Teague'; 'Arturo.Ballesteros@senate.state.tx.us'; 'Sean.Abbott@senate.state.tx.us'; 'Herman Settemeyer'; 'Jim Harrison'; 'Kathy Alexander'; 'Linda Brookins'; 'Ronald L. Ellis'; 'Robin Smith'  
**Subject:** RE: Water Rights for the Hidalgo County Water Facilities Plan

Good morning Kathy,

Have you been able to look at the location map for WR 4524?

Thanks.

*Deren Li, Ph.D., P.E., D.WRE, CFM  
Civil Systems Engineering Inc.  
9894 Bissonnet St., Suite 404  
Houston, Texas 77036  
713-298-6819 (c)  
713-782-3811 (o)  
[www.cseengineers.com](http://www.cseengineers.com)*

---

**From:** Kellye Rila [mailto:KRILA@tceq.state.tx.us]  
**Sent:** Friday, August 20, 2010 3:32 PM  
**To:** Deren  
**Cc:** [scrain@atlashall.com](mailto:scrain@atlashall.com); 'Godfrey Garza'; 'Sharlotte' 'Teague'; [Arturo.Ballesteros@senate.state.tx.us](mailto:Arturo.Ballesteros@senate.state.tx.us); [Sean.Abbott@senate.state.tx.us](mailto:Sean.Abbott@senate.state.tx.us); Herman Settemeyer; Jim Harrison; Kathy Alexander; Linda Brookins; Ronald L. Ellis; Robin Smith  
**Subject:** Re: Water Rights for the Hidalgo County Water Facilities Plan  
**Importance:** High

Deren:

**Thank you for the additional information provided on August 10, 2010. Staff has researched information related to water rights in Hidalgo County in the Nueces Rio Grande Coastal Basin. During the Final Determination of Water Rights in the Nueces Rio Grande Coastal Basin, which was approved in court, a Certificate of Adjudication (22-4524) was granted to Hidalgo County Water Improvement District No. 6, which subsequently became the Engleman Irrigation District. In addition to authorizing diversion of water transferred from the Rio Grande Basin, the certificate authorizes diversion of 254.5 acre-feet of Nueces Rio Grande Coastal Basin water from the Hidalgo County Drainage District Drain. The Hidalgo County Drainage District Drain and the Donna Drain were determined to be watercourses in the certificate and were further designated as tributaries to the Laguna Madre. Therefore, staff believes a water rights permit would be required for diversion from this watercourse.**

**With the exception of Certificate 22-4523, the remaining attached water rights authorize diversion of Nueces Rio Grande Coastal Basin water from flood control features, which were defined as watercourses in the adjudication and diversions would require a water rights permit.**

There are potential options that might make some water available for diversion for your project in this area. We would be happy to meet with you to discuss these options further.

There are a number of TPDES permits authorizing discharge into drains, canals and other flood control features. The Texas Water Code (Chapter 26) requires an authorization to discharge sewage, and municipal, recreational, agricultural, or industrial waste into or adjacent to any water in the state.

If you have additional questions, please contact Kellye Rila at [krila@tceq.state.tx.us](mailto:krila@tceq.state.tx.us), or by phone at 512-239-4612. If you have questions about the GIS information, or need assistance for the ftp site, please contact Kathy Alexander at [kalexand@tceq.state.tx.us](mailto:kalexand@tceq.state.tx.us), or by phone at 512-239-0778.

Attached are the following documents:

Water Use Permits 5300 and 5045

Certificates of Adjudication 22-4520 to 22-4525.

Copy of the front matter from the Final Determination of Water Rights in the Nueces Rio Grande Coastal Basin.

Copy of the Final Determination for Certificate 22-4524

Copy of Texas Water Code §26.121

Copy of excerpt from 30 TAC §307.3 providing the definition of Surface water in the state

Due to technical issues involved with transmitting GIS data via email, the GIS information for water right locations and wastewater treatment plant outfalls within the boundary of the North Main Drain watershed are available at:

<ftp://ftp.tceq.state.tx.us/pub/WaterResourceManagement/WaterQuantity/GIS/HidalgoCounty/>

>>> "Deren" <[dli@cseengineers.com](mailto:dli@cseengineers.com)> 8/10/2010 2:44 PM >>>  
Kellye,

Based on our meeting yesterday at TCEQ and the concerns of the existing water rights within the watershed for this project, we have further investigated the TCEQ water rights GIS database obtained from TCEQ previously. Based on the GIS database, there are five (5) water rights within the watershed. They are 12205396001, 12205396002, 12205396003, 62204523401 and 62204524401/62204524501, as shown in the attached Exhibit.

Based on the WRActive and WRinactive excel files (from TCEQ), we agree that there are two active water rights (62204523401 and 62204524401/62204524501) within the watershed. However, the source of both water rights is the Rio Grande River. As explained in the database, the locations of both water rights are used for storage purposes. The other three water rights (12205396001, 12205396002, and 12205396003) are not active. It should be noted that water rights 12205396002 and 12205396003 are probably incorrectly geocoded in the database since there are no Dry Creek or Colorado River within Hidalgo County. As shown in the WRinactive excel file, these two rights are located in Real and Travis Counties, respectively.

Hopefully this information will expedite TCEQ's decision-making process regarding this water rights issue.

If you have any questions or need additional information regarding this matter, please let me know.

Sincerely,

*Deren Li, Ph.D., P.E., D.WRE, CFM  
Civil Systems Engineering Inc.*

**9894 Bissonnet St., Suite 404**  
**Houston, Texas 77036**  
**713-298-6819 (c)**  
**713-782-3811 (o)**  
**[www.cseengineers.com](http://www.cseengineers.com)**

## Deren

---

**From:** Deren [dli@cseengineers.com]  
**Sent:** Thursday, September 02, 2010 11:09 AM  
**To:** 'Kellye Rila'  
**Cc:** 'scrain@atlashall.com'; 'Godfrey Garza'; 'Sharlotte' 'Teague'; 'Arturo.Ballesteros@senate.state.tx.us'; 'Sean.Abbott@senate.state.tx.us'; 'Herman Settemeyer'; 'Jim Harrison'; 'Kathy Alexander'; 'Linda Brookins'; 'Ronald L. Ellis'; 'Robin Smith'; 'lora.briones'  
**Subject:** RE: Water Rights for the Hidalgo County Water Facilities Plan  
**Attachments:** Exhibit 1 - Watershed Map.jpg; Exhibit 2 - LiDarTopoMap.jpg; Exhibit 3 - Aerial Photo.jpg

Kellye,

We have conducted an additional investigation to the water rights issues related to the Hidalgo County Water Facilities Planning Project based on the GIS data and Water Rights Certificates provided by TCEQ, as well as available aerial photographs, LiDAR DEM topographic, street map, and telephone conversations with Engelman Irrigation District. Based on our investigation, we believe that the drainage water as proposed to be developed within the North Main Drain and Main Floodwater Channel does not belong to the State of Texas according to the Water Law of Texas, and a water right permit should not be required. The reasons for this conclusion are as follows:

1. **Exhibit 1** shows the overall drainage patterns in relation to the existing water rights. It should be noted there are a total of two (2) existing water rights certificates (6220**4523**401 and 6220**4524**401) issued within the North Main Drain - Main Floodwater Channel Watershed, where the water development for the Hidalgo County Water Facilities Planning Project is located. Certificate **4523** is related to an off-channel storage which stores Rio Grande River water via irrigation canal and pipeline systems that are parallel to the HCDD 1 drainage ditches. Certificate **4524** is also related to off-channel reservoirs which store Rio Grande River Water via irrigation canal and pipeline systems that are parallel to the HCDD 1 drainage ditches and water from Hidalgo County Drainage District Drain and Donna Drain (no longer exist as explained in Item 2). Certificates 4520, 4521, 4522, 4524 and 4525 are all located within SE Hidalgo County Watershed and all related to **IBWC North Floodway** which is a branch of IBWC Main Floodway (Arroyo Colorado is another branch) and diverts flood water from Rio Grande River during extreme flood events.
2. Based on telephone conversations with Engelman Irrigation District, LiDAR topographic data (**Exhibit 2**) and Aerial Photography Map (**Exhibit 3**), the Hidalgo County Drainage District Drain and Donna Drain no longer exist. The Rio Grande River is the only source for the two off-channel reservoirs for Water Right Certificate 4524.
3. By examining the high precision LiDAR topographic data and aerial photograph, there are no natural streams (waterways) within the North Main Drain - Floodwater Channel Watershed draining to the drainage systems within the watershed.

Please let me know if you have any questions and need additional information.

Sincerely,

**Deren Li, Ph.D., P.E., D.WRE, CFM**  
**Civil Systems Engineering Inc.**

**9894 Bissonnet St., Suite 404**  
**Houston, Texas 77036**  
**713-298-6819 (c)**  
**713-782-3811 (o)**  
[www.cseengineers.com](http://www.cseengineers.com)

---

**From:** Kellye Rila [mailto:KRILA@tceq.state.tx.us]  
**Sent:** Wednesday, August 25, 2010 11:05 AM  
**To:** Deren  
**Cc:** [scrain@atlashall.com](mailto:scrain@atlashall.com); 'Godfrey Garza'; 'Sharlotte' 'Teague'; [Arturo.Ballesteros@senate.state.tx.us](mailto:Arturo.Ballesteros@senate.state.tx.us); [Sean.Abbott@senate.state.tx.us](mailto:Sean.Abbott@senate.state.tx.us); Herman Settemeyer; Jim Harrison; Kathy Alexander; Linda Brookins; Ronald L. Ellis; Robin Smith  
**Subject:** RE: Water Rights for the Hidalgo County Water Facilities Plan

Deren:

As Kathy explained on the phone, the actual adjudication map is an old 1980's blue line aerial map. We are attempting to make a readable copy to send to you. In the meantime, the point location is available on the GIS coverage on the ftp site. We will get you the adjudication map copy as soon as possible.

Kellye

>>> "Deren" <[dli@cseengineers.com](mailto:dli@cseengineers.com)> 8/25/2010 10:30 AM >>>  
Good morning Kathy,

Have you been able to look at the location map for WR 4524?

Thanks.

**Deren Li, Ph.D., P.E., D.WRE, CFM**  
**Civil Systems Engineering Inc.**  
**9894 Bissonnet St., Suite 404**  
**Houston, Texas 77036**  
**713-298-6819 (c)**  
**713-782-3811 (o)**  
[www.cseengineers.com](http://www.cseengineers.com)

---

**From:** Kellye Rila [mailto:KRILA@tceq.state.tx.us]  
**Sent:** Friday, August 20, 2010 3:32 PM  
**To:** Deren  
**Cc:** [scrain@atlashall.com](mailto:scrain@atlashall.com); 'Godfrey Garza'; 'Sharlotte' 'Teague'; [Arturo.Ballesteros@senate.state.tx.us](mailto:Arturo.Ballesteros@senate.state.tx.us); [Sean.Abbott@senate.state.tx.us](mailto:Sean.Abbott@senate.state.tx.us); Herman Settemeyer; Jim Harrison; Kathy Alexander; Linda Brookins; Ronald L. Ellis; Robin Smith  
**Subject:** Re: Water Rights for the Hidalgo County Water Facilities Plan  
**Importance:** High

Deren:

**Thank you for the additional information provided on August 10, 2010. Staff has researched information related to water rights in Hidalgo County in the Nueces Rio Grande Coastal Basin. During the Final Determination of Water Rights in the Nueces Rio Grande Coastal Basin, which was approved in court, a Certificate of Adjudication (22-4524) was granted to Hidalgo County Water Improvement District No. 6, which subsequently became the Engleman Irrigation District. In addition to authorizing diversion of water transferred from the Rio Grande Basin, the certificate**



authorizes diversion of 254.5 acre-feet of Nueces Rio Grande Coastal Basin water from the Hidalgo County Drainage District Drain. The Hidalgo County Drainage District Drain and the Donna Drain were determined to be watercourses in the certificate and were further designated as tributaries to the Laguna Madre. Therefore, staff believes a water rights permit would be required for diversion from this watercourse.

With the exception of Certificate 22-4523, the remaining attached water rights authorize diversion of Nueces Rio Grande Coastal Basin water from flood control features, which were defined as watercourses in the adjudication and diversions would require a water rights permit.

There are potential options that might make some water available for diversion for your project in this area. We would be happy to meet with you to discuss these options further.

There are a number of TPDES permits authorizing discharge into drains, canals and other flood control features. The Texas Water Code (Chapter 26) requires an authorization to discharge sewage, and municipal, recreational, agricultural, or industrial waste into or adjacent to any water in the state.

If you have additional questions, please contact Kellye Rila at [krila@tceq.state.tx.us](mailto:krila@tceq.state.tx.us), or by phone at 512-239-4612. If you have questions about the GIS information, or need assistance for the ftp site, please contact Kathy Alexander at [kalexand@tceq.state.tx.us](mailto:kalexand@tceq.state.tx.us), or by phone at 512-239-0778.

Attached are the following documents:

Water Use Permits 5300 and 5045

Certificates of Adjudication 22-4520 to 22-4525.

Copy of the front matter from the Final Determination of Water Rights in the Nueces Rio Grande Coastal Basin.

Copy of the Final Determination for Certificate 22-4524

Copy of Texas Water Code §26.121

Copy of excerpt from 30 TAC §307.3 providing the definition of Surface water in the state

Due to technical issues involved with transmitting GIS data via email, the GIS information for water right locations and wastewater treatment plant outfalls within the boundary of the North Main Drain watershed are available at:

<ftp://ftp.tceq.state.tx.us/pub/WaterResourceManagement/WaterQuantity/GIS/HidalgoCounty/>

>>> "Deren" <[dli@cseengineers.com](mailto:dli@cseengineers.com)> 8/10/2010 2:44 PM >>>  
Kellye,

Based on our meeting yesterday at TCEQ and the concerns of the existing water rights within the watershed for this project, we have further investigated the TCEQ water rights GIS database obtained from TCEQ previously. Based on the GIS database, there are five (5) water rights within the watershed. They are 12205396001, 12205396002, 12205396003, 62204523401 and 62204524401/62204524501, as shown in the attached Exhibit.

Based on the WRActive and WRInactive excel files (from TCEQ), we agree that there are two active water rights (62204523401 and 62204524401/62204524501) within the watershed. However, the source of both water rights is the Rio Grande River. As explained in the database, the locations of both water rights are used for storage purposes. The other three water rights (12205396001, 12205396002, and 12205396003) are not active. It should be noted that water rights 12205396002 and 12205396003 are probably incorrectly geocoded in the database since there are no Dry Creek

or Colorado River within Hidalgo County. As shown in the WRInactive excel file, these two rights are located in Real and Travis Counties, respectively.

Hopefully this information will expedite TCEQ's decision-making process regarding this water rights issue.

If you have any questions or need additional information regarding this matter, please let me know.

Sincerely,

*Deren Li, Ph.D., P.E., D.WRE, CFM*  
*Civil Systems Engineering Inc.*  
*9894 Bissonnet St., Suite 404*  
*Houston, Texas 77036*  
*713-298-6819 (c)*  
*713-782-3811 (o)*  
[www.cseengineers.com](http://www.cseengineers.com)

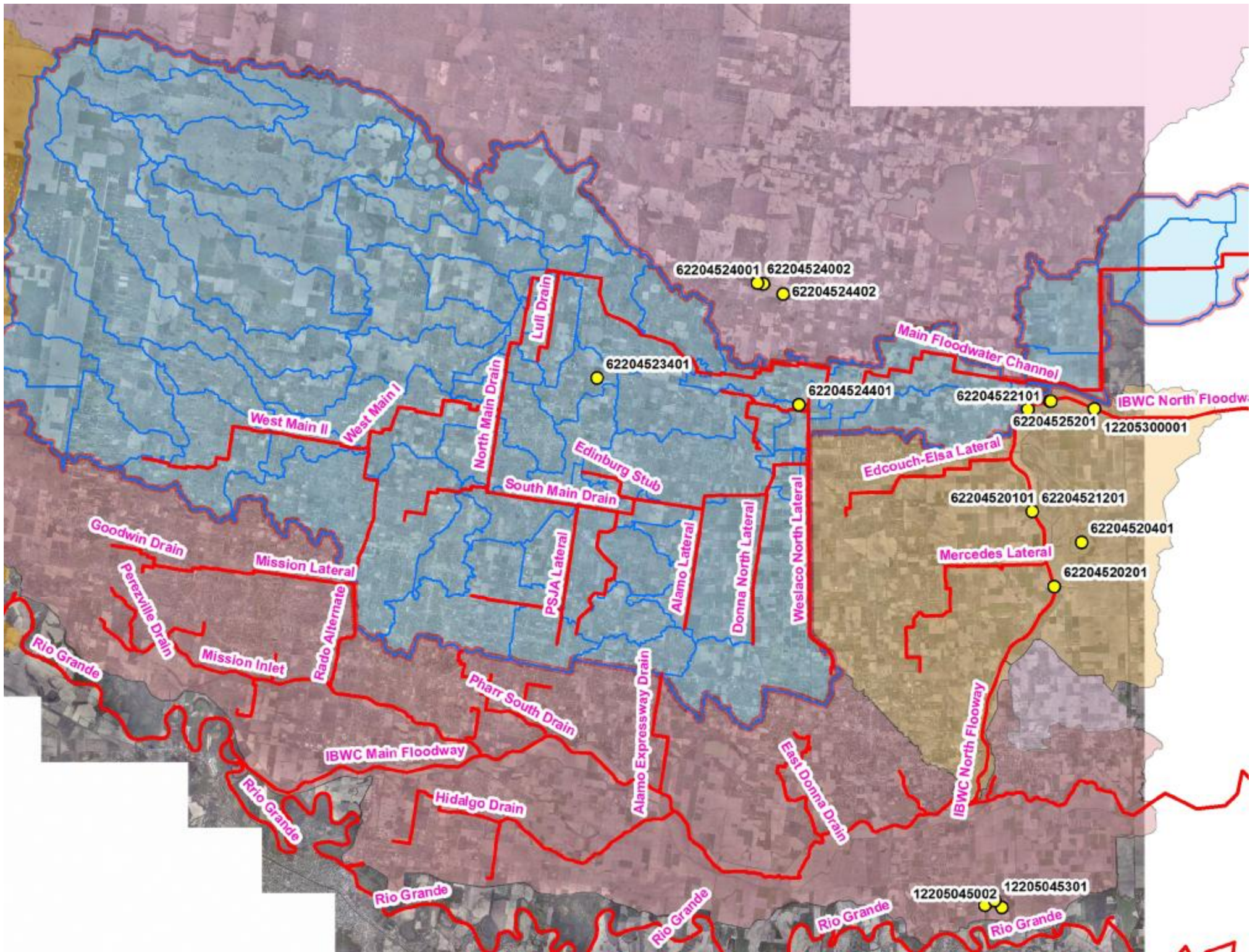



Sunflower

F-M Rd 493

Monte Christo

62204524401

La Blanca

Engelman Gardens

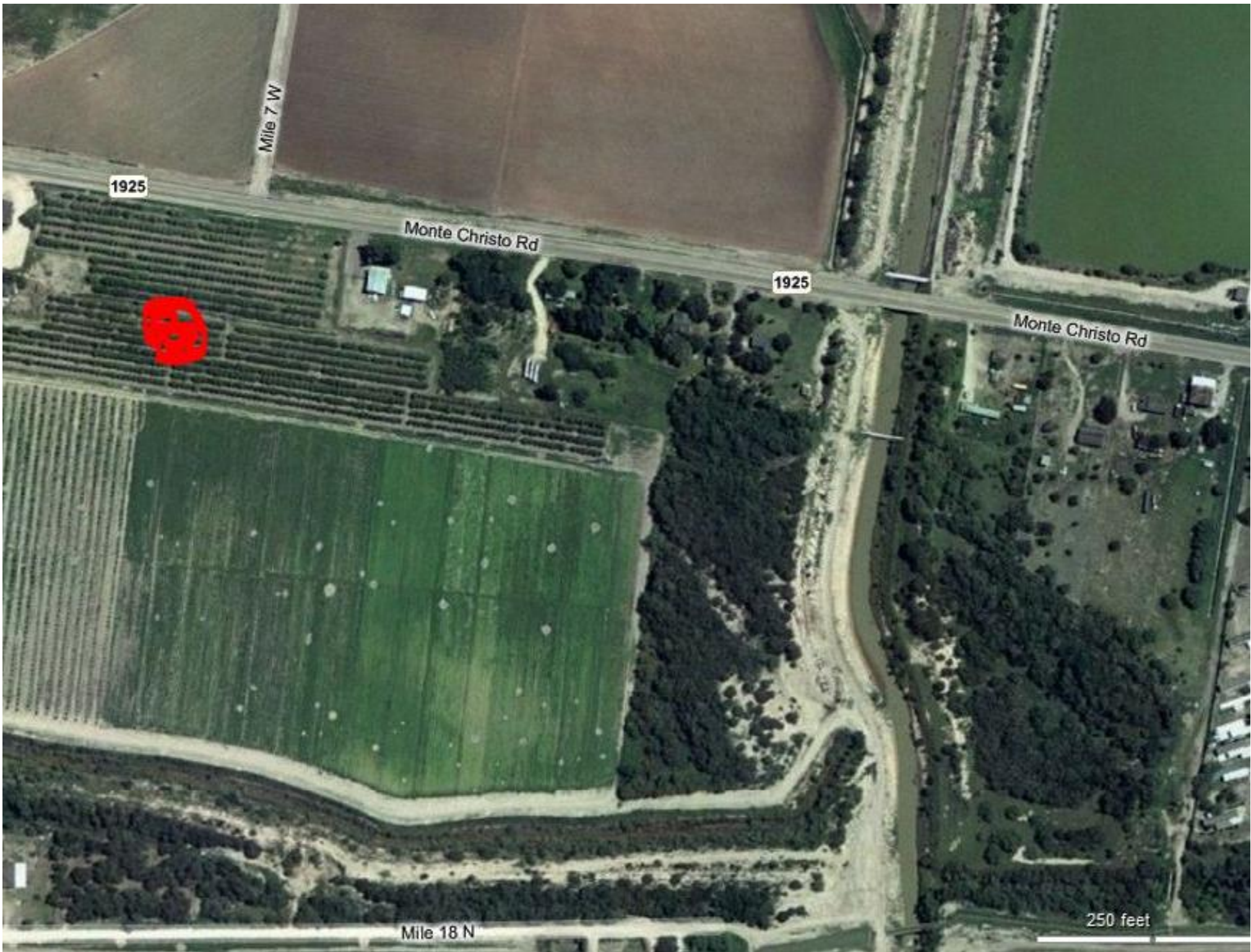

1925

Mile 7 W

Monte Cristo Rd

1925

Monte Cristo Rd

Mile 18 N

250 feet

## Deren

---

**From:** Deren [dli@cseengineers.com]  
**Sent:** Friday, September 10, 2010 2:38 PM  
**To:** 'Kellye Rila'  
**Cc:** 'scrain@atlashall.com'; 'Godfrey Garza'; 'lora.briones'; 'Sharlotte' 'Teague'; 'Arturo.Ballesteros@senate.state.tx.us'; 'Sean.Abbott\_SC@senate.state.tx.us'; 'Herman Settemeyer'; 'Jim Harrison'; 'Kathy Alexander'; 'Linda Brookins'; 'Ronald L. Ellis'; 'Robin Smith'; 'Todd Galiga'  
**Subject:** RE: Water Rights for the Hidalgo County Water Facilities Plan

Kellye,  
Would you let me know what is the status of the review of the information I sent to you on Sept. 2, 2010.

Thank you,

*Deren Li, Ph.D., P.E., D.WRE, CFM*  
*Civil Systems Engineering Inc.*  
*9894 Bissonnet St., Suite 404*  
*Houston, Texas 77036*  
*713-298-6819 (c)*  
*713-782-3811 (o)*  
[www.cseengineers.com](http://www.cseengineers.com)

---

**From:** Kellye Rila [mailto:KRILA@tceq.state.tx.us]  
**Sent:** Friday, September 03, 2010 9:00 AM  
**To:** Deren  
**Cc:** [scrain@atlashall.com](mailto:scrain@atlashall.com); 'Godfrey Garza'; 'lora.briones'; 'Sharlotte' 'Teague'; [Arturo.Ballesteros@senate.state.tx.us](mailto:Arturo.Ballesteros@senate.state.tx.us); [Sean.Abbott\\_SC@senate.state.tx.us](mailto:Sean.Abbott_SC@senate.state.tx.us); Herman Settemeyer; Jim Harrison; Kathy Alexander; Linda Brookins; Ronald L. Ellis; Robin Smith; Todd Galiga  
**Subject:** RE: Water Rights for the Hidalgo County Water Facilities Plan  
**Importance:** High

Deren:

We will forward this information to our legal staff and management for review.

Kellye

>>> "Deren" <[dli@cseengineers.com](mailto:dli@cseengineers.com)> 9/2/2010 11:08 AM >>>  
Kellye,

We have conducted an additional investigation to the water rights issues related to the Hidalgo County Water Facilities Planning Project based on the GIS data and Water Rights Certificates provided by TCEQ, as well as available aerial photographs, LiDAR DEM topographic, street map, and telephone conversations with Engelman Irrigation District. Based on our investigation, we believe that the drainage water as proposed to be developed within the North Main Drain and Main Floodwater Channel does not belong to the State of Texas according to the Water Law of Texas, and a water right permit should not be required. The reasons for this conclusion are as follows:

1. **Exhibit I** shows the overall drainage patterns in relation to the existing water rights. It should be noted there are a total of two (2) existing water rights certificates (6220**4523**401 and 6220**4524**401) issued within the North Main Drain - Main Floodwater Channel Watershed,

where the water development for the Hidalgo County Water Facilities Planning Project is located. Certificate **4523** is related to an off-channel storage which stores Rio Grande River water via irrigation canal and pipeline systems that are parallel to the HCDD 1 drainage ditches. Certificate **4524** is also related to off-channel reservoirs which store Rio Grande River Water via irrigation canal and pipeline systems that are parallel to the HCDD 1 drainage ditches and water from Hidalgo County Drainage District Drain and Donna Drain (no longer exist as explained in Item 2). Certificates 4520, 4521, 4522, 4524 and 4525 are all located within SE Hidalgo County Watershed and all related to **IBWC North Floodway** which is a branch of IBWC Main Floodway (Arroyo Colorado is another branch) and diverts flood water from Rio Grande River during extreme flood events.

2. Based on telephone conversations with Engelman Irrigation District, LiDAR topographic data (*Exhibit 2*) and Aerial Photography Map (*Exhibit 3*), the Hidalgo County Drainage District Drain and Donna Drain no longer exist. The Rio Grande River is the only source for the two off-channel reservoirs for Water Right Certificate 4524.
3. By examining the high precision LiDAR topographic data and aerial photograph, there are no natural streams (waterways) within the North Main Drain - Floodwater Channel Watershed draining to the drainage systems within the watershed.

Please let me know if you have any questions and need additional information.

Sincerely,

**Deren Li, Ph.D., P.E., D.WRE, CFM**  
**Civil Systems Engineering Inc.**  
**9894 Bissonnet St., Suite 404**  
**Houston, Texas 77036**  
**713-298-6819 (c)**  
**713-782-3811 (o)**  
[www.cseengineers.com](http://www.cseengineers.com)

---

**From:** Kellye Rila [mailto:KRILA@tceq.state.tx.us]  
**Sent:** Wednesday, August 25, 2010 11:05 AM  
**To:** Deren  
**Cc:** [scrain@atlashall.com](mailto:scrain@atlashall.com); 'Godfrey Garza'; 'Sharlotte' 'Teague'; [Arturo.Ballesteros@senate.state.tx.us](mailto:Arturo.Ballesteros@senate.state.tx.us); [Sean.Abbott@senate.state.tx.us](mailto:Sean.Abbott@senate.state.tx.us); Herman Settemeyer; Jim Harrison; Kathy Alexander; Linda Brookins; Ronald L. Ellis; Robin Smith  
**Subject:** RE: Water Rights for the Hidalgo County Water Facilities Plan

Deren:

As Kathy explained on the phone, the actual adjudication map is an old 1980's blue line aerial map. We are attempting to make a readable copy to send to you. In the meantime, the point location is available on the GIS coverage on the ftp site. We will get you the adjudication map copy as soon as possible.

Kellye

>>> "Deren" <[dli@cseengineers.com](mailto:dli@cseengineers.com)> 8/25/2010 10:30 AM >>>  
Good morning Kathy,

Have you been able to look at the location map for WR 4524?

Thanks.

**Deren Li, Ph.D., P.E., D.WRE, CFM**  
**Civil Systems Engineering Inc.**  
**9894 Bissonnet St., Suite 404**  
**Houston, Texas 77036**  
**713-298-6819 (c)**  
**713-782-3811 (o)**  
[www.cseengineers.com](http://www.cseengineers.com)

---

**From:** Kellye Rila [<mailto:KRILA@tceq.state.tx.us>]  
**Sent:** Friday, August 20, 2010 3:32 PM  
**To:** Deren  
**Cc:** [scrain@atlashall.com](mailto:scrain@atlashall.com); 'Godfrey Garza'; Sharlotte 'Teague'; [Arturo.Ballesteros@senate.state.tx.us](mailto:Arturo.Ballesteros@senate.state.tx.us); [Sean.Abbott@senate.state.tx.us](mailto:Sean.Abbott@senate.state.tx.us); Herman Settemeyer; Jim Harrison; Kathy Alexander; Linda Brookins; Ronald L. Ellis; Robin Smith  
**Subject:** Re: Water Rights for the Hidalgo County Water Facilities Plan  
**Importance:** High

Deren:

**Thank you for the additional information provided on August 10, 2010. Staff has researched information related to water rights in Hidalgo County in the Nueces Rio Grande Coastal Basin. During the Final Determination of Water Rights in the Nueces Rio Grande Coastal Basin, which was approved in court, a Certificate of Adjudication (22-4524) was granted to Hidalgo County Water Improvement District No. 6, which subsequently became the Engleman Irrigation District. In addition to authorizing diversion of water transferred from the Rio Grande Basin, the certificate authorizes diversion of 254.5 acre-feet of Nueces Rio Grande Coastal Basin water from the Hidalgo County Drainage District Drain. The Hidalgo County Drainage District Drain and the Donna Drain were determined to be watercourses in the certificate and were further designated as tributaries to the Laguna Madre. Therefore, staff believes a water rights permit would be required for diversion from this watercourse.**

**With the exception of Certificate 22-4523, the remaining attached water rights authorize diversion of Nueces Rio Grande Coastal Basin water from flood control features, which were defined as watercourses in the adjudication and diversions would require a water rights permit.**

**There are potential options that might make some water available for diversion for your project in this area. We would be happy to meet with you to discuss these options further.**

**There are a number of TPDES permits authorizing discharge into drains, canals and other flood control features. The Texas Water Code (Chapter 26) requires an authorization to discharge sewage, and municipal, recreational, agricultural, or industrial waste into or adjacent to any water in the state.**

**If you have additional questions, please contact Kellye Rila at [krila@tceq.state.tx.us](mailto:krila@tceq.state.tx.us), or by phone at 512-239-4612. If you have questions about the GIS information, or need assistance for the ftp site, please contact Kathy Alexander at [kalexand@tceq.state.tx.us](mailto:kalexand@tceq.state.tx.us), or by phone at 512-239-0778.**

**Attached are the following documents:**

**Water Use Permits 5300 and 5045**

**Certificates of Adjudication 22-4520 to 22-4525.**



**Copy of the front matter from the Final Determination of Water Rights in the Nueces Rio Grande Coastal Basin.**

**Copy of the Final Determination for Certificate 22-4524**

**Copy of Texas Water Code §26.121**

**Copy of excerpt from 30 TAC §307.3 providing the definition of Surface water in the state**

**Due to technical issues involved with transmitting GIS data via email, the GIS information for water right locations and wastewater treatment plant outfalls within the boundary of the North Main Drain watershed are available at:**

**<ftp://ftp.tceq.state.tx.us/pub/WaterResourceManagement/WaterQuantity/GIS/HidalgoCounty/>**

>>> "Deren" <dli@cseengineers.com> 8/10/2010 2:44 PM >>>  
Kellye,

Based on our meeting yesterday at TCEQ and the concerns of the existing water rights within the watershed for this project, we have further investigated the TCEQ water rights GIS database obtained from TCEQ previously. Based on the GIS database, there are five (5) water rights within the watershed. They are 12205396001, 12205396002, 12205396003, 62204523401 and 62204524401/62204524501, as shown in the attached Exhibit.

Based on the WRActive and WRInactive excel files (from TCEQ), we agree that there are two active water rights (62204523401 and 62204524401/62204524501) within the watershed. However, the source of both water rights is the Rio Grande River. As explained in the database, the locations of both water rights are used for storage purposes. The other three water rights (12205396001, 12205396002, and 12205396003) are not active. It should be noted that water rights 12205396002 and 12205396003 are probably incorrectly geocoded in the database since there are no Dry Creek or Colorado River within Hidalgo County. As shown in the WRInactive excel file, these two rights are located in Real and Travis Counties, respectively.

Hopefully this information will expedite TCEQ's decision-making process regarding this water rights issue.

If you have any questions or need additional information regarding this matter, please let me know.

Sincerely,

*Deren Li, Ph.D., P.E., D.WRE, CFM  
Civil Systems Engineering Inc.  
9894 Bissonnet St., Suite 404  
Houston, Texas 77036  
713-298-6819 (c)  
713-782-3811 (o)  
[www.cseengineers.com](http://www.cseengineers.com)*

## Deren

---

**From:** Deren [dli@cseengineers.com]  
**Sent:** Monday, September 20, 2010 10:04 AM  
**To:** 'Kellye Rila'  
**Cc:** 'scrain@atlashall.com'; 'Godfrey Garza'; 'Iora.briones'; 'Sharlotte' 'Teague'; 'Arturo.Ballesteros@senate.state.tx.us'; 'Sean.Abbott\_SC@senate.state.tx.us'; 'Herman Settemeyer'; 'Jim Harrison'; 'Kathy Alexander'; 'Linda Brookins'; 'Ronald L. Ellis'; 'Robin Smith'; 'Todd Galiga'  
**Subject:** RE: Water Rights for the Hidalgo County Water Facilities Plan

Good morning Kellye,

Could you please let me know the status of TCEQ's legal review, and provide me with a timeline for the completion of the review?

As we have to meet the project schedule for TWDB and Hidalgo County Drainage District No.1, we would like to have this water rights issue resolved as soon as possible. The entire project is currently stalled pending the TCEQ's decision. Without this water rights issue resolved, the project can't move forward as scheduled.

Thanks.

*Deren Li, Ph.D., P.E., D.WRE, CFM*  
*Civil Systems Engineering Inc.*  
*9894 Bissonnet St., Suite 404*  
*Houston, Texas 77036*  
*713-298-6819 (c)*  
*713-782-3811 (o)*  
[www.cseengineers.com](http://www.cseengineers.com)

---

**From:** Kellye Rila [mailto:KRILA@tceq.state.tx.us]  
**Sent:** Friday, September 10, 2010 2:40 PM  
**To:** Deren  
**Cc:** [scrain@atlashall.com](mailto:scrain@atlashall.com); 'Godfrey Garza'; 'Iora.briones'; 'Sharlotte' 'Teague'; [Arturo.Ballesteros@senate.state.tx.us](mailto:Arturo.Ballesteros@senate.state.tx.us); [Sean.Abbott\\_SC@senate.state.tx.us](mailto:Sean.Abbott_SC@senate.state.tx.us); Herman Settemeyer; Jim Harrison; Kathy Alexander; Linda Brookins; Ronald L. Ellis; Robin Smith; Todd Galiga  
**Subject:** RE: Water Rights for the Hidalgo County Water Facilities Plan

Deren:

Our attorney is out of town and we will be discussing when she returns and then discussing with our management.

Kellye

>>> "Deren" <dli@cseengineers.com> 9/10/2010 2:38 PM >>>

Kellye,

Would you let me know what is the status of the review of the information I sent to you on Sept. 2, 2010.

Thank you,

*Deren Li, Ph.D., P.E., D.WRE, CFM*  
*Civil Systems Engineering Inc.*  
*9894 Bissonnet St., Suite 404*  
*Houston, Texas 77036*

From: Kellye Rila [mailto:KRILA@tceq.state.tx.us]

Sent: Friday, September 03, 2010 9:00 AM

To: Deren

Cc: [scrain@atlashall.com](mailto:scrain@atlashall.com); 'Godfrey Garza'; 'lora.briones'; 'Sharlotte' 'Teague'; [Arturo.Ballesteros@senate.state.tx.us](mailto:Arturo.Ballesteros@senate.state.tx.us); [Sean.Abbott\\_SC@senate.state.tx.us](mailto:Sean.Abbott_SC@senate.state.tx.us); Herman Settemeyer; Jim Harrison; Kathy Alexander; Linda Brookins; Ronald L. Ellis; Robin Smith; Todd Galiga

Subject: RE: Water Rights for the Hidalgo County Water Facilities Plan

Importance: High

Deren:

We will forward this information to our legal staff and management for review.

Kellye

>>> "Deren" <[dli@cseengineers.com](mailto:dli@cseengineers.com)> 9/2/2010 11:08 AM >>>

Kellye,

We have conducted an additional investigation to the water rights issues related to the Hidalgo County Water Facilities Planning Project based on the GIS data and Water Rights Certificates provided by TCEQ, as well as available aerial photographs, LiDAR DEM topographic, street map, and telephone conversations with Engelman Irrigation District. Based on our investigation, we believe that the drainage water as proposed to be developed within the North Main Drain and Main Floodwater Channel does not belong to the State of Texas according to the Water Law of Texas, and a water right permit should not be required. The reasons for this conclusion are as follows:

1. **Exhibit 1** shows the overall drainage patterns in relation to the existing water rights. It should be noted there are a total of two (2) existing water rights certificates (6220**4523**401 and 6220**4524**401) issued within the North Main Drain - Main Floodwater Channel Watershed, where the water development for the Hidalgo County Water Facilities Planning Project is located. Certificate **4523** is related to an off-channel storage which stores Rio Grande River water via irrigation canal and pipeline systems that are parallel to the HCDD 1 drainage ditches. Certificate **4524** is also related to off-channel reservoirs which store Rio Grande River Water via irrigation canal and pipeline systems that are parallel to the HCDD 1 drainage ditches and water from Hidalgo County Drainage District Drain and Donna Drain (no longer exist as explained in Item 2). Certificates 4520, 4521, 4522, 4524 and 4525 are all located within SE Hidalgo County Watershed and all related to **IBWC North Floodway** which is a branch of IBWC Main Floodway (Arroyo Colorado is another branch) and diverts flood water from Rio Grande River during extreme flood events.
2. Based on telephone conversations with Engelman Irrigation District, LiDAR topographic data (**Exhibit 2**) and Aerial Photography Map (**Exhibit 3**), the Hidalgo County Drainage District Drain and Donna Drain no longer exist. The Rio Grande River is the only source for the two off-channel reservoirs for Water Right Certificate 4524.
3. By examining the high precision LiDAR topographic data and aerial photograph, there are no natural streams (waterways) within the North Main Drain - Floodwater Channel Watershed draining to the drainage systems within the watershed.

Please let me know if you have any questions and need additional information.

Sincerely,

***Deren Li, Ph.D., P.E., D.WRE, CFM***  
***Civil Systems Engineering Inc.***  
***9894 Bissonnet St., Suite 404***  
***Houston, Texas 77036***  
***713-298-6819 (c)***  
***713-782-3811 (o)***  
***[www.cseengineers.com](http://www.cseengineers.com)***

---

**From:** Kellye Rila [<mailto:KRILA@tceq.state.tx.us>]  
**Sent:** Wednesday, August 25, 2010 11:05 AM  
**To:** Deren  
**Cc:** [scrain@atlashall.com](mailto:scrain@atlashall.com); 'Godfrey Garza'; 'Sharlotte' 'Teague'; [Arturo.Ballesteros@senate.state.tx.us](mailto:Arturo.Ballesteros@senate.state.tx.us); [Sean.Abbott@senate.state.tx.us](mailto:Sean.Abbott@senate.state.tx.us); Herman Settemeyer; Jim Harrison; Kathy Alexander; Linda Brookins; Ronald L. Ellis; Robin Smith  
**Subject:** RE: Water Rights for the Hidalgo County Water Facilities Plan

Deren:

As Kathy explained on the phone, the actual adjudication map is an old 1980's blue line aerial map. We are attempting to make a readable copy to send to you. In the meantime, the point location is available on the GIS coverage on the ftp site. We will get you the adjudication map copy as soon as possible.

Kellye

>>> "Deren" <[dli@cseengineers.com](mailto:dli@cseengineers.com)> 8/25/2010 10:30 AM >>>  
Good morning Kathy,

Have you been able to look at the location map for WR 4524?

Thanks.

***Deren Li, Ph.D., P.E., D.WRE, CFM***  
***Civil Systems Engineering Inc.***  
***9894 Bissonnet St., Suite 404***  
***Houston, Texas 77036***  
***713-298-6819 (c)***  
***713-782-3811 (o)***  
***[www.cseengineers.com](http://www.cseengineers.com)***

---

**From:** Kellye Rila [<mailto:KRILA@tceq.state.tx.us>]  
**Sent:** Friday, August 20, 2010 3:32 PM  
**To:** Deren  
**Cc:** [scrain@atlashall.com](mailto:scrain@atlashall.com); 'Godfrey Garza'; 'Sharlotte' 'Teague'; [Arturo.Ballesteros@senate.state.tx.us](mailto:Arturo.Ballesteros@senate.state.tx.us); [Sean.Abbott@senate.state.tx.us](mailto:Sean.Abbott@senate.state.tx.us); Herman Settemeyer; Jim Harrison; Kathy Alexander; Linda Brookins; Ronald L. Ellis; Robin Smith  
**Subject:** Re: Water Rights for the Hidalgo County Water Facilities Plan  
**Importance:** High

Deren:

Thank you for the additional information provided on August 10, 2010. Staff has researched information related to water rights in Hidalgo County in the Nueces Rio Grande Coastal Basin. During the Final Determination of Water Rights in the Nueces Rio Grande Coastal Basin, which was approved in court, a Certificate of Adjudication (22-4524) was granted to Hidalgo County Water Improvement District No. 6, which subsequently became the Engleman Irrigation District. In addition to authorizing diversion of water transferred from the Rio Grande Basin, the certificate authorizes diversion of 254.5 acre-feet of Nueces Rio Grande Coastal Basin water from the Hidalgo County Drainage District Drain. The Hidalgo County Drainage District Drain and the Donna Drain were determined to be watercourses in the certificate and were further designated as tributaries to the Laguna Madre. Therefore, staff believes a water rights permit would be required for diversion from this watercourse.

With the exception of Certificate 22-4523, the remaining attached water rights authorize diversion of Nueces Rio Grande Coastal Basin water from flood control features, which were defined as watercourses in the adjudication and diversions would require a water rights permit.

There are potential options that might make some water available for diversion for your project in this area. We would be happy to meet with you to discuss these options further.

There are a number of TPDES permits authorizing discharge into drains, canals and other flood control features. The Texas Water Code (Chapter 26) requires an authorization to discharge sewage, and municipal, recreational, agricultural, or industrial waste into or adjacent to any water in the state.

If you have additional questions, please contact Kellye Rila at [krila@tceq.state.tx.us](mailto:krila@tceq.state.tx.us), or by phone at 512-239-4612. If you have questions about the GIS information, or need assistance for the ftp site, please contact Kathy Alexander at [kalexand@tceq.state.tx.us](mailto:kalexand@tceq.state.tx.us), or by phone at 512-239-0778.

Attached are the following documents:

Water Use Permits 5300 and 5045

Certificates of Adjudication 22-4520 to 22-4525.

Copy of the front matter from the Final Determination of Water Rights in the Nueces Rio Grande Coastal Basin.

Copy of the Final Determination for Certificate 22-4524

Copy of Texas Water Code §26.121

Copy of excerpt from 30 TAC §307.3 providing the definition of Surface water in the state

Due to technical issues involved with transmitting GIS data via email, the GIS information for water right locations and wastewater treatment plant outfalls within the boundary of the North Main Drain watershed are available at:

<ftp://ftp.tceq.state.tx.us/pub/WaterResourceManagement/WaterQuantity/GIS/HidalgoCounty/>

>>> "Deren" <[dli@cseengineers.com](mailto:dli@cseengineers.com)> 8/10/2010 2:44 PM >>>  
Kellye,

Based on our meeting yesterday at TCEQ and the concerns of the existing water rights within the watershed for this project, we have further investigated the TCEQ water rights GIS database obtained from TCEQ previously. Based on the GIS database, there are five (5) water rights within the watershed. They are 12205396001, 12205396002, 12205396003, 62204523401 and 62204524401/62204524501, as shown in the attached Exhibit.

Based on the WRActive and WRInactive excel files (from TCEQ), we agree that there are two active water rights (62204523401 and 62204524401/62204524501) within the watershed. However, the source of both water rights is the Rio Grande River. As explained in the database, the locations of both water rights are used for storage purposes. The other three water rights (12205396001, 12205396002, and 12205396003) are not active. It should be noted that water rights 12205396002 and 12205396003 are probably incorrectly geocoded in the database since there are no Dry Creek or Colorado River within Hidalgo County. As shown in the WRInactive excel file, these two rights are located in Real and Travis Counties, respectively.

Hopefully this information will expedite TCEQ's decision-making process regarding this water rights issue.

If you have any questions or need additional information regarding this matter, please let me know.

Sincerely,

*Deren Li, Ph.D., P.E., D.WRE, CFM*  
*Civil Systems Engineering Inc.*  
*9894 Bissonnet St., Suite 404*  
*Houston, Texas 77036*  
*713-298-6819 (c)*  
*713-782-3811 (o)*  
[www.cseengineers.com](http://www.cseengineers.com)

## Deren

---

**From:** Kellye Rila [KRILA@tceq.state.tx.us]  
**Sent:** Monday, September 20, 2010 10:13 AM  
**To:** Deren  
**Cc:** [scrain@atlashall.com](mailto:scrain@atlashall.com); 'Godfrey Garza'; 'lora.briones'; 'Sharlotte' 'Teague'; [Arturo.Ballesteros@senate.state.tx.us](mailto:Arturo.Ballesteros@senate.state.tx.us); [Sean.Abbott\\_SC@senate.state.tx.us](mailto:Sean.Abbott_SC@senate.state.tx.us); Herman Settemeyer; Jim Harrison; Kathy Alexander; Linda Brookins; Ronald L. Ellis; Robin Smith; Todd Galiga  
**Subject:** RE: Water Rights for the Hidalgo County Water Facilities Plan

Deren:

We have reviewed the information provided. Based on the certificate of adjudication and other information we have reviewed, we believe the determination that a state watercourse, and therefore, state water is in place and therefore, this project would require a water rights permit.

Kellye

>>> "Deren" <[dli@cseengineers.com](mailto:dli@cseengineers.com)> 9/20/2010 10:04 AM >>>  
Good morning Kellye,

Could you please let me know the status of TCEQ's legal review, and provide me with a timeline for the completion of the review?

As we have to meet the project schedule for TWDB and Hidalgo County Drainage District No.1, we would like to have this water rights issue resolved as soon as possible. The entire project is currently stalled pending the TCEQ's decision. Without this water rights issue resolved, the project can't move forward as scheduled.

Thanks.

*Deren Li, Ph.D., P.E., D.WRE, CFM*  
*Civil Systems Engineering Inc.*  
*9894 Bissonnet St., Suite 404*  
*Houston, Texas 77036*  
*713-298-6819 (c)*  
*713-782-3811 (o)*  
[www.cseengineers.com](http://www.cseengineers.com)

---

**From:** Kellye Rila [<mailto:KRILA@tceq.state.tx.us>]  
**Sent:** Friday, September 10, 2010 2:40 PM  
**To:** Deren  
**Cc:** [scrain@atlashall.com](mailto:scrain@atlashall.com); 'Godfrey Garza'; 'lora.briones'; 'Sharlotte' 'Teague'; [Arturo.Ballesteros@senate.state.tx.us](mailto:Arturo.Ballesteros@senate.state.tx.us); [Sean.Abbott\\_SC@senate.state.tx.us](mailto:Sean.Abbott_SC@senate.state.tx.us); Herman Settemeyer; Jim Harrison; Kathy Alexander; Linda Brookins; Ronald L. Ellis; Robin Smith; Todd Galiga  
**Subject:** RE: Water Rights for the Hidalgo County Water Facilities Plan

Deren:

Our attorney is out of town and we will be discussing when she returns and then discussing with our management.

Kellye

>>> "Deren" <[dli@cseengineers.com](mailto:dli@cseengineers.com)> 9/10/2010 2:38 PM >>>  
Kellye,

Would you let me know what is the status of the review of the information I sent to you on Sept. 2, 2010.

Thank you,

**Deren Li, Ph.D., P.E., D.WRE, CFM**  
**Civil Systems Engineering Inc.**  
**9894 Bissonnet St., Suite 404**  
**Houston, Texas 77036**  
**713-298-6819 (c)**  
**713-782-3811 (o)**  
[www.cseengineers.com](http://www.cseengineers.com)

---

**From:** Kellye Rila [mailto:KRILA@tceq.state.tx.us]  
**Sent:** Friday, September 03, 2010 9:00 AM  
**To:** Deren  
**Cc:** [scrain@atlashall.com](mailto:scrain@atlashall.com); 'Godfrey Garza'; 'lora.briones'; 'Sharlotte' 'Teague'; [Arturo.Ballesteros@senate.state.tx.us](mailto:Arturo.Ballesteros@senate.state.tx.us); [Sean.Abbott\\_SC@senate.state.tx.us](mailto:Sean.Abbott_SC@senate.state.tx.us); Herman Settemeyer; Jim Harrison; Kathy Alexander; Linda Brookins; Ronald L. Ellis; Robin Smith; Todd Galiga  
**Subject:** RE: Water Rights for the Hidalgo County Water Facilities Plan  
**Importance:** High

Deren:

We will forward this information to our legal staff and management for review.

Kellye

>>> "Deren" <[dli@cseengineers.com](mailto:dli@cseengineers.com)> 9/2/2010 11:08 AM >>>  
Kellye,

We have conducted an additional investigation to the water rights issues related to the Hidalgo County Water Facilities Planning Project based on the GIS data and Water Rights Certificates provided by TCEQ, as well as available aerial photographs, LiDAR DEM topographic, street map, and telephone conversations with Engelman Irrigation District. Based on our investigation, we believe that the drainage water as proposed to be developed within the North Main Drain and Main Floodwater Channel does not belong to the State of Texas according to the Water Law of Texas, and a water right permit should not be required. The reasons for this conclusion are as follows:

1. **Exhibit 1** shows the overall drainage patterns in relation to the existing water rights. It should be noted there are a total of two (2) existing water rights certificates (6220**4523**401 and 6220**4524**401) issued within the North Main Drain - Main Floodwater Channel Watershed, where the water development for the Hidalgo County Water Facilities Planning Project is located. Certificate **4523** is related to an off-channel storage which stores Rio Grande River water via irrigation canal and pipeline systems that are parallel to the HCDD 1 drainage ditches. Certificate **4524** is also related to off-channel reservoirs which store Rio Grande River Water via irrigation canal and pipeline systems that are parallel to the HCDD 1 drainage ditches and water from Hidalgo County Drainage District Drain and Donna Drain (no longer exist as explained in Item 2). Certificates 4520, 4521, 4522, 4524 and 4525 are all located within SE Hidalgo County Watershed and all related to **IBWC North Floodway** which is a branch of IBWC Main Floodway (Arroyo Colorado is another branch) and diverts flood water from Rio Grande River during extreme flood events.



2. Based on telephone conversations with Engelman Irrigation District, LiDAR topographic data (*Exhibit 2*) and Aerial Photography Map (*Exhibit 3*), the Hidalgo County Drainage District Drain and Donna Drain no longer exist. The Rio Grande River is the only source for the two off-channel reservoirs for Water Right Certificate 4524.
3. By examining the high precision LiDAR topographic data and aerial photograph, there are no natural streams (waterways) within the North Main Drain - Floodwater Channel Watershed draining to the drainage systems within the watershed.

Please let me know if you have any questions and need additional information.

Sincerely,

***Deren Li, Ph.D., P.E., D.WRE, CFM***  
***Civil Systems Engineering Inc.***  
***9894 Bissonnet St., Suite 404***  
***Houston, Texas 77036***  
***713-298-6819 (c)***  
***713-782-3811 (o)***  
***[www.cseengineers.com](http://www.cseengineers.com)***

---

**From:** Kellye Rila [mailto:KRILA@tceq.state.tx.us]  
**Sent:** Wednesday, August 25, 2010 11:05 AM  
**To:** Deren  
**Cc:** [scrain@atlashall.com](mailto:scrain@atlashall.com); 'Godfrey Garza'; 'Sharlotte' 'Teague'; [Arturo.Ballesteros@senate.state.tx.us](mailto:Arturo.Ballesteros@senate.state.tx.us); [Sean.Abbott@senate.state.tx.us](mailto:Sean.Abbott@senate.state.tx.us); Herman Settemeyer; Jim Harrison; Kathy Alexander; Linda Brookins; Ronald L. Ellis; Robin Smith  
**Subject:** RE: Water Rights for the Hidalgo County Water Facilities Plan

Deren:

As Kathy explained on the phone, the actual adjudication map is an old 1980's blue line aerial map. We are attempting to make a readable copy to send to you. In the meantime, the point location is available on the GIS coverage on the ftp site. We will get you the adjudication map copy as soon as possible.

Kellye

>>> "Deren" <[dli@cseengineers.com](mailto:dli@cseengineers.com)> 8/25/2010 10:30 AM >>>  
Good morning Kathy,

Have you been able to look at the location map for WR 4524?

Thanks.

***Deren Li, Ph.D., P.E., D.WRE, CFM***  
***Civil Systems Engineering Inc.***  
***9894 Bissonnet St., Suite 404***  
***Houston, Texas 77036***  
***713-298-6819 (c)***  
***713-782-3811 (o)***  
***[www.cseengineers.com](http://www.cseengineers.com)***

---

**From:** Kellye Rila [mailto:KRILA@tceq.state.tx.us]  
**Sent:** Friday, August 20, 2010 3:32 PM

To: Deren

Cc: [scrain@atlashall.com](mailto:scrain@atlashall.com); 'Godfrey Garza'; Sharlotte 'Teague'; [Arturo.Ballesteros@senate.state.tx.us](mailto:Arturo.Ballesteros@senate.state.tx.us); [Sean.Abbott@senate.state.tx.us](mailto:Sean.Abbott@senate.state.tx.us); Herman Settemeyer; Jim Harrison; Kathy Alexander; Linda Brookins; Ronald L. Ellis; Robin Smith

Subject: Re: Water Rights for the Hidalgo County Water Facilities Plan

Importance: High

Deren:

**Thank you for the additional information provided on August 10, 2010. Staff has researched information related to water rights in Hidalgo County in the Nueces Rio Grande Coastal Basin. During the Final Determination of Water Rights in the Nueces Rio Grande Coastal Basin, which was approved in court, a Certificate of Adjudication (22-4524) was granted to Hidalgo County Water Improvement District No. 6, which subsequently became the Engleman Irrigation District. In addition to authorizing diversion of water transferred from the Rio Grande Basin, the certificate authorizes diversion of 254.5 acre-feet of Nueces Rio Grande Coastal Basin water from the Hidalgo County Drainage District Drain. The Hidalgo County Drainage District Drain and the Donna Drain were determined to be watercourses in the certificate and were further designated as tributaries to the Laguna Madre. Therefore, staff believes a water rights permit would be required for diversion from this watercourse.**

**With the exception of Certificate 22-4523, the remaining attached water rights authorize diversion of Nueces Rio Grande Coastal Basin water from flood control features, which were defined as watercourses in the adjudication and diversions would require a water rights permit.**

**There are potential options that might make some water available for diversion for your project in this area. We would be happy to meet with you to discuss these options further.**

**There are a number of TPDES permits authorizing discharge into drains, canals and other flood control features. The Texas Water Code (Chapter 26) requires an authorization to discharge sewage, and municipal, recreational, agricultural, or industrial waste into or adjacent to any water in the state.**

**If you have additional questions, please contact Kellye Rila at [krila@tceq.state.tx.us](mailto:krila@tceq.state.tx.us), or by phone at 512-239-4612. If you have questions about the GIS information, or need assistance for the ftp site, please contact Kathy Alexander at [kalexand@tceq.state.tx.us](mailto:kalexand@tceq.state.tx.us), or by phone at 512-239-0778.**

**Attached are the following documents:**

**Water Use Permits 5300 and 5045**

**Certificates of Adjudication 22-4520 to 22-4525.**

**Copy of the front matter from the Final Determination of Water Rights in the Nueces Rio Grande Coastal Basin.**

**Copy of the Final Determination for Certificate 22-4524**

**Copy of Texas Water Code §26.121**

**Copy of excerpt from 30 TAC §307.3 providing the definition of Surface water in the state**

**Due to technical issues involved with transmitting GIS data via email, the GIS information for water right locations and wastewater treatment plant outfalls within the boundary of the North Main Drain watershed are available at:**

**<ftp://ftp.tceq.state.tx.us/pub/WaterResourceManagement/WaterQuantity/GIS/HidalgoCounty/>**

>>> "Deren" <dli@cseengineers.com> 8/10/2010 2:44 PM >>>  
Kellye,

Based on our meeting yesterday at TCEQ and the concerns of the existing water rights within the watershed for this project, we have further investigated the TCEQ water rights GIS database obtained from TCEQ previously. Based on the GIS database, there are five (5) water rights within the watershed. They are 12205396001, 12205396002, 12205396003, 62204523401 and 62204524401/62204524501, as shown in the attached Exhibit.

Based on the WRActive and WRInactive excel files (from TCEQ), we agree that there are two active water rights (62204523401 and 62204524401/62204524501) within the watershed. However, the source of both water rights is the Rio Grande River. As explained in the database, the locations of both water rights are used for storage purposes. The other three water rights (12205396001, 12205396002, and 12205396003) are not active. It should be noted that water rights 12205396002 and 12205396003 are probably incorrectly geocoded in the database since there are no Dry Creek or Colorado River within Hidalgo County. As shown in the WRInactive excel file, these two rights are located in Real and Travis Counties, respectively.

Hopefully this information will expedite TCEQ's decision-making process regarding this water rights issue.

If you have any questions or need additional information regarding this matter, please let me know.

Sincerely,

*Deren Li, Ph.D., P.E., D.WRE, CFM*  
*Civil Systems Engineering Inc.*  
*9894 Bissonnet St., Suite 404*  
*Houston, Texas 77036*  
*713-298-6819 (c)*  
*713-782-3811 (o)*  
[www.cseengineers.com](http://www.cseengineers.com)

## APPENDIX B



## Texas Commission on Environmental Quality

PO Box 13087, MC-160, Austin, Texas 78711-3087

Telephone (512) 239-4691, FAX (512) 239-4770

### **INSTRUCTIONS TO PREPARE AN APPLICATION FOR A PERMIT TO APPROPRIATE PUBLIC WATER**

**(SECTIONS 11.121, 11.042, 11.085 or 11.143, TEXAS WATER CODE)  
TEXAS ADMINISTRATIVE CODE CHAPTERS 30, 50, 281, 287, 288, 295, 297, AND/OR 299**

Copies of *Obtaining TCEQ Rules*, publication GI-032, are available from TCEQ Publications at (512) 239-0028 or from various outside sources. In addition, you may access these forms through the internet at [www.tceq.state.tx.us](http://www.tceq.state.tx.us).

Use a typewriter or print in ink (do not write in longhand) to complete the form. Return the original application form and six (6) copies to the Commission. Retain a copy and instruction sheets for your records. In addition, provide six (6) copies of application plans and supporting materials (certain small projects may not require plans). One set of the plans, if required, shall be on a reproducible medium.

Mail completed application and related materials to the letterhead address above. (Please note: if including a check, mail directly to P.O. Box 13088, Austin, TX 78711-3088).

Statutorily required fees are one-time fees and must be paid before any action will be taken on an application. The usual fees are shown on the attached fee sheet (see Attachment A). For additional fee provisions, see 30 Texas Administrative Code (TAC) §§ 295.131-139.

#### INSTRUCTIONS FOR COMPLETING FORM TCEQ-10214:

##### **1. Applicant Information**

###### **A. Applicant Name and Contact Information**

###### **B. Customer Reference Number**

If you do not have a Customer Reference Number, complete Section II of the Core Data Form (TCEQ-10400) and submit it with this application.

###### **C. Fees and Penalties**

The application will not be processed until all delinquent fees and/or penalties owed to the TCEQ or the Office of the Attorney General on behalf of the TCEQ are paid.

###### **D. Lienholder Information**

Provide this information on the holder of any liens on any land to which the water right would be appurtenant.

##### **2. Dam (structure), Reservoir, and Watercourse Data:**

###### **A. Type of Storage Reservoir**

Select the appropriate description combination by checking (✓) the type of storage structure. If diversion is to be directly from a watercourse (no dam/reservoir), list the watercourse(s) from which such direct diversion is proposed in 2.B below.

- **On-Channel Reservoir** (30 TAC § 297.23): A permit for an on-channel reservoir grants the right to the permittee to construct and/or maintain a dam on the stream or watercourse. The application must request an appropriate right to fill the reservoir and to use the water in place or divert water for use.
- **Off-Channel Reservoir** (30 TAC § 297.24): A permit for an off-channel reservoir grants the right to the permittee to construct and/or maintain a structure impounding State water so that same will not be directly on the stream or watercourse. As above, the application must request an appropriate right to fill the reservoir and divert directly from a stream or watercourse, either by pump or gravity flow, and to use in place or divert from the reservoir.
- **Existing Structure** (30 TAC § 295.42): Provide the date that the structure was constructed.

- **Proposed Structure** (30 TAC § 295.42): Applicant shall provide a copy of the notice that was mailed to each member of the governing body of each county and municipality in which the reservoir, or any part of the reservoir, will be located as well as copies of the certified mailing cards.
- **Exempt Structure** (Texas Water Code (TWC) § 11.142a or 11.142b): a 200 acre-foot capacity or less reservoir (stock tank/pond) may be created and used only for domestic, livestock, and/or fish and wildlife purposes. TWC § 11.143 allows for the use of water from an exempt reservoir for a purpose other than domestic, livestock, and/or fish and wildlife, (*i.e.*, agricultural, mining, municipal, etc.)

If the reservoir in which water will be stored was constructed as a project of the NRCS, United States Department of Agriculture, consent must be obtained from the Soil & Water Conservation District and/or other Local Sponsor(s) having jurisdiction over the reservoir (30 TAC § 295.12).

If the reservoir is owned by more than one individual, see page 3 of these instructions under Item 4A.

### B. Location of Structure

1. **Watercourse:** Indicate watercourse on which dam or structure will be/is located. The staff can complete the "tributary" information if not known.
2. **Location from County Seat and Nearby Town:** This is necessary location/mapping information.
3. **Zip Code:** Provide zip code where structure is located.
4. & 5. Reference a point, station number or end of dam along the centerline of the dam (as may be shown on your application drawings). Provide the Latitude and Longitude coordinates in decimal degrees, to at least six decimal places and indicate the method used to calculate the diversion point location. For example, Latitude 98.016330°N, Longitude 32.067122°W, also bearing N 68° W, 4000 feet (bearing and distance) from the southeast corner of the Richard Roe Original Survey No. 33, Abstract No. 433, in Travis County, Texas. Attach additional sheet(s) to the application in the form of supplement(s) if more than one point of diversion is requested. Said sheets are attached to the application and are available upon request to the Commission. Give name(s) and number(s) of the Original Survey(s), Abstract No.(s) and County(s) in which the dam is to be located.

### C. Reservoir:

1. **Acre-feet:** Enter the acre-feet of water impounded.
2. **Surface area:** Enter the surface area, in acres, of the reservoir at normal maximum operating level. The normal maximum operating level is generally at the lowest ungated outlet. The area-elevation-capacity information is required for larger projects.

D. **Drainage Area Above the Dam/Reservoir:** Provide the drainage area in square miles and/or acres of the reservoir and/or diversion point, if available.

### E. Other

1. **U.S. Natural Resources Conservation Service:** If it is a NRCS floodwater-retarding structure, give site number and name of the watershed project.
2. **Authorization to close ports or windows:** If a permit is requested to close the "ports" or "windows" in the service spillway, indicate this by checking (✓) the applicable box.

### 3. Appropriation/Diversion Request (total amount of water needed):

- A. **Use:** Give the purpose of use, place of use, and number of acre-feet per year requested for each purpose use listed.

**B. Lands to be irrigated:**

1. **Acres:** Fill in the blanks indicating the number of acres to be irrigated, the total acres in the tract(s) and the county(s) where the land is located. Attach a copy of the deed to the land, including the county recording information.
2. **Location:** Reference the Survey Name and Abstract and/or Original Survey number.

**C. Diversion Point Information: Provide a completed *Supplemental Diversion Point Information Sheet* for any additional diversion points**

1. **Watercourse:** Indicate the watercourse where the diversion will take place. The staff can complete the "tributary" information if not known.
2. **Latitude and Longitude:** Reference the point of diversion by stating its Latitude, Longitude in decimal degrees, to at least six decimal places (indicate method used to calculate the diversion point location), and bearing to a corner of an Original Land Survey. For example-Latitude 98.016330°N, Longitude 32.065122°W also bearing N 68° W, 4000 feet (bearing and distance) from the southeast corner of the Richard Roe Original Survey No. 33, Abstract No. 433, in Travis County, Texas. Attach additional sheet(s) to the application in the form of supplement(s) if more than one point of diversion is requested. Said sheets are attached to the application and are available upon request to the Commission.
3. **Location from County Seat and Nearby Town:** This is essential map reference information.
4. **Zip Code:** Provide the zip code for where the diversion point is located.
5. **Diversion from stream:** Check (✓) the appropriate boxes. Attach additional sheets as necessary to explain fully the plan of diversion.
6. **Rate of Diversion:** If diversion is from a diversion facility, complete the blanks under "Diversion Facility". If diversion is by gravity, complete the blanks under "If by gravity". Give the maximum total rate of diversion in gallons per minute (gpm) for each diversion point.
7. **Drainage Area Above Diversion Point:** Provide the drainage area in square miles and/or acres of the diversion point, if available.

**D. Return Water of Return Flow:** Return Water or Surplus Water, Section 295.8: If water is to be returned to a stream, list the stream to which the water will be returned. Reference the point of return by Latitude, Longitude in decimal degrees, to at least six decimal places, (indicate the method used to calculate the diversion point location), zip code, and bearing and distance to an Original Survey corner. The staff can complete the tributary information if not known. Provide the estimated annual amount of water that will be returned in acre-feet.

**E. Surplus Water:** Surplus water is that portion of the requested diversion from a stream or reservoir which will not be consumed during the requested use. This section does not apply to sprinkler irrigation systems. Of the quantity of water requested for diversion, estimate the annual amount of water which may be returned to a watercourse.

**4. Discharge Point Information.**

- A. Source of Water.** Indicate whether the water being discharged is treated effluent, groundwater, or other.
- B. Latitude and Longitude:** Reference the point of discharge by stating its Latitude, Longitude in decimal degrees, to at least six decimal places (indicate the method used to calculate the diversion point location), and bearing to a corner of an Original Land Survey. For example-Latitude 98.016330°N, Longitude 32.065122°W also bearing N 68° W, 4000 feet (bearing and distance) from the southeast corner of the Richard Roe Original Survey No. 33, Abstract No. 433, in Travis County, Texas. Attach additional sheet(s) to the application in the form of supplement(s)

if more than one point of discharge is requested. Said sheets are attached to the application and are available upon request to the Commission.

- C. **Location from County Seat and Nearby Town:** This is necessary location/mapping information.
- D. **Zip Code.** Provide the zip code for where the discharge point is located.
- E. **Watercourse.** Indicate the watercourse where the discharge will take place.
- F. **Discharge Rate.** Indicate the maximum rate of discharge (cfs and gpm).
- G. **Amount of Water Discharged.** Indicate the amount of water to be discharged (acre-feet per year).
- H. **Purpose of Use.** Indicate the purpose of use for the water being discharged.
- I. **Additional Information.** Provide additional information if the water to be discharged is groundwater or treated effluent.

**5. General Information:**

- A. If the reservoir site, diversion, and distribution facilities are located, or are to be located, entirely on land owned by applicant, insert word "applicant". If part of the facilities are to be located on lands not owned by the applicant, 30 TAC § 295.10 applies. Insert the names of such landowners on the application form. Also refer to 30 TAC §§ 295.121-.126 concerning requirements for plans/maps.

30 TAC § 295.11 provides that except as otherwise provided herein, if an existing reservoir inundates land owned by more than one person, an application for a permit to authorize the dam and reservoir and use of the State water impounded in the reservoir shall be joined in by all the landowners. A copy of any operating agreement affecting the reservoir or the distribution of water therefrom shall be submitted with the application. If there is incomplete joinder, the applicant shall submit the name and address of any landowner who does not join the application, and shall file a copy of an easement or a consent, license, lease or other type of agreement from the landowner(s), as provided in 30 TAC § 295.10.

- B. Application should give reasonable anticipated starting and completion dates of construction consistent with the following provisions: The applicant must begin actual construction of proposed direct diversion facilities within two years after a permit is issued and prosecute the work diligently and continuously to completion. For the construction of a storage reservoir, the maximum time to commence construction may not exceed 2 years from the date of issuance of the permit. However, Time Extensions may be requested in accordance with 30 TAC § 295.72.
  - C. Applicant shall provide a conservation plan which meets the minimum requirements for such plans under 30 TAC § 288 and containing information which demonstrates that reasonable diligence will be used to avoid waste and achieve water conservation. Also, see 30 TAC § 295.9.
  - D. If applicable, state the quantity of water for each purpose of use which the applicant seeks to transfer. State the basin of origin of the water and the receiving basin. See 30 TAC §§ 295.13, 295.155, and 297.18.
  - E. If applicable, state the quantity of water and watercourse to be used. See 30 TAC §§ 295.111-295.113.
  - F. Coastal Zone - relative to Coastal Zone Management Program.
- 5. **Maps, plats, plans, and drawings:** Submit appropriate maps, plats, plans and/or drawings in accordance with the appropriate Commission rules. See ATTACHMENT B for information on how to obtain USGS 7.5 minute topographic maps.
  - 6. If the dam(s) and reservoir(s) were constructed for domestic, livestock, and/or fish and wildlife purposes and you now wish to seek a permit under TWC § 11.143, please check (✓) this box.
  - 7. Provide information describing how this application addresses a water supply need in a manner that is consistent with the state water plan or the applicable approved regional water plan for any



area in which the proposed appropriation is located or, in the alternative, describe conditions that warrant a waiver of this requirement.

- ❖ SIGN AND HAVE THE APPLICATION NOTARIZED. This will be your sworn statement of the facts contained in the application. Everyone listed as an applicant must sign the application and have his or her signature notarized. A duly appointed agent may sign for the applicant before a notary public and provide a copy of the appointment granting agent status.
- ❖ Additional information may be needed to process the application. See supplemental sheets for a general outline of information typically needed to process an application. **Consultation with the staff is recommended, pre-application meetings can be arranged.**

## ATTACHMENT A

### WATER USE PERMIT APPLICATION FEES

The usual fees for water use applications are:

Filing Fees for a water use permit or an application for extension of time to begin or complete construction shall be based upon the total amount of water requested to be appropriated for impoundment and diversion as follows:

- (a) less than 100 acre-feet - \$100;
- (b) 100 - 5,000 acre-feet - \$250;
- (c) 5,001 - 10,000 acre-feet - \$500;
- (d) 10,001 - 250,000 acre-feet - \$1,000; and
- (e) greater than 250,000 acre-feet - \$2,000.

Fees to amend a water right are \$100 per numbered water right requested to be amended, including combination amendments.

Recording Fee \$1.25 per page of application.

Agricultural Use 50¢ per acre for each acre of land to be irrigated per year.

Storage Fee \*50¢ per acre-foot of storage \*(storage is based on the total holding capacity of the reservoir at normal maximum operating level).

In-Place Recreation Use \$1.00 per acre-foot of reservoir storage.

Other Uses \$1.00 per acre-foot based on maximum annual diversion (does not apply to agricultural use).

Mail Notice Fee The cost of mailing notice to persons in the affected river basin varies. The applicant shall pay the total cost of mailing notice and the Executive Director will advise the applicant of the number of persons to whom notice is mailed and the total mailing cost.

**NOTE:** The cost of any required publication of notice shall be paid by the applicant directly to the newspaper involved.

Mail Notice Fee In (\_\_\_\_\_) River Basin -- \$\_\_\_\_\_

Max. Use Fee \$50,000 for first use and \$10,000 for any additional use

Max. Use Fee for Temporary Applications \$500.00

Max. Use Fee for Extension of Time to Begin or Complete Construction \$1,000.00

## **ATTACHMENT B**

### **Additional Water Use Permit Application Requirements**

Texas Administrative Code 30 (TAC), §§ 295.121-295.126 provides the requirements for Maps, Plats, and Drawings Accompanying Application for a Water Use Permit. In accordance with the requirement of § 295.124(d), the Executive Director is now requiring water use permit applicants to provide the appropriate USGS 7.5 Minute Topographic Map(s) of the applicant's project area, including as necessary, the location of dams, diversion points, discharge points, irrigated lands, easements, and/or other pertinent features, as appropriate.

Six copies of the application are required; therefore one original topographic map and six (6) copies are required. However, when an applicant's area falls on two or more topographic maps, a composite map of the area, along with six (6) copies of the composite will be adequate, provided the composite includes the quadrangle name and number.

For your information, topographic maps can be obtained from numerous commercial dealers or directly from the U.S. GEOLOGICAL SURVEY, at 1-800-275-8747 (ASK-USGS) or write to USGS Information Services, Box 25286, Denver, Colorado 80225. USGS may allow maps to be ordered directly over the Internet at <http://mapping.usgs.gov/products/map/usgsmaps.html>.

You may also contact the Water Rights Permitting Team at (512) 239-4691 should you need additional assistance or information.

**TEXAS COMMISSION ON ENVIRONMENTAL QUALITY**  
**APPLICATION FOR PERMIT TO APPROPRIATE STATE WATER**  
(SECTION 11.121, 11.042, 11.085 OR 11.143, TEXAS WATER CODE)  
TAC CHAPTERS 30, 50, 281, 287, 288, 295, 297 AND 299  
**Water Supply Division, Water Rights Permitting MC-160**

**P.O. Box 13087**

**Austin, Texas 78711-3087**

**Telephone (512) 239-4691, FAX (512) 239-4770**

(if including a check, mail directly to P.O. Box 13088, Austin, TX 78711-3088)

Notice: This form will not be processed until all delinquent fees and/or penalties owed to the TCEQ or the Office of the Attorney General on behalf of the TCEQ are paid in accordance with the Delinquent Fee and Penalty Protocol.

**1. Applicant Information.**

A. Applicant Name(s): \_\_\_\_\_

Mailing Address: \_\_\_\_\_  
\_\_\_\_\_

Telephone Number: \_\_\_\_\_ Fax Number: \_\_\_\_\_

Email Address: \_\_\_\_\_

B. Customer Reference Number (if issued): CN \_\_\_\_\_

**Note:** If you do not have a Customer Reference Number, complete Section II of the Core Data Form (TCEQ-10400) and submit it with this application.

C. Fees and Penalties

Applicant owes fees or penalties?

Yes       No

If yes, provide the amount and the nature of the fee or penalty as well as any identifying number:

\_\_\_\_\_

D. Lienholder Information

Provide this information on the holder of any liens on any land to which the water right would be appurtenant):

\_\_\_\_\_

**2. Dam (structure), Reservoir and Watercourse Data.**

A. Type of Storage Reservoir (indicate by checking (√) all applicable)

on-channel     off-channel     existing structure     proposed structure\*     exempt structure\*\*

\* Applicant shall provide a copy of the notice that was mailed to each member of the governing body of each county and municipality in which the reservoir, or any part of the reservoir, will be located as well as copies of the certified mailing cards.

\*\* TWC Section 11.143 for uses of water for other than domestic, livestock, or fish and wildlife from an existing, exempt reservoir with a capacity of 200 acre-feet or less. Please complete Paragraph 6 below if proceeding under TWC 11.143.

Date of Construction: \_\_\_\_\_

B. Location of Structure No. \_\_\_\_\_

- 1) Watercourse: \_\_\_\_\_
- 2) Location from County Seat: \_\_\_\_\_ miles in a \_\_\_\_\_ direction from \_\_\_\_\_, \_\_\_\_\_ County, Texas.  
 Location from nearby town (if other than County Seat): \_\_\_\_\_ miles in a \_\_\_\_\_ direction from \_\_\_\_\_, a nearby town shown on county highway map.
- 3) Zip Code: \_\_\_\_\_
- 4) The dam will be/is located in the \_\_\_\_\_ Original Survey No. \_\_\_\_\_, Abstract No. \_\_\_\_\_ in \_\_\_\_\_ County, Texas.
- 5) Station \_\_\_\_\_ on the centerline of the dam is \_\_\_\_\_° \_\_\_\_\_ (bearing), \_\_\_\_\_ feet (distance) from the \_\_\_\_\_ corner of \_\_\_\_\_ Original Survey No. \_\_\_\_\_, Abstract No. \_\_\_\_\_, in \_\_\_\_\_ County, Texas, also being at Latitude \_\_\_\_\_°N, Longitude \_\_\_\_\_°W. **Provide the Latitude and Longitude coordinates in decimal degrees, to at least six decimal places, and indicate the method used to calculate the diversion point location.**

C. Reservoir:

- 1) Acre-feet of water impounded by structure at normal maximum operating level: \_\_\_\_\_
- 2) Surface area in acres of reservoir at normal maximum operating level: \_\_\_\_\_

D. Drainage Area

The drainage area above the dam is \_\_\_\_\_ acres or \_\_\_\_\_ square miles.

E. Other

- 1) If this is a U.S. Natural Resources Conservation Service (NRCS) (formerly Soil Conservation Service (SCS)) floodwater-retarding structure, provide the Site No. \_\_\_\_\_ and watershed project name \_\_\_\_\_.
- 2) Do you request authorization to close the "ports" or "windows" in the service spillway?  
 Yes       No

**3. Appropriation/Diversion Request (total amount of water needed, including maximum projected uses and accounting for evaporative losses for off-channel storage, if applicable).**

A. Appropriated water will be used as follows:

	Purpose*	Place of Use	Acre-feet per year
1)			
2)			
3)			

\*If agricultural use, list crops(s) to be irrigated:

\_\_\_\_\_

B. Lands to be irrigated (if applicable):

- 1) Applicant proposes to irrigate a total of \_\_\_\_\_ acres in any one year. This acreage is all of or part of a larger tract(s) which is described in a supplement attached to this application and contains a total of \_\_\_\_\_ acres in \_\_\_\_\_ County, Texas. A copy of the deed(s) describing the overall tract(s) with the recording information from the county records is attached.
- 2) Location of land to be irrigated: In the \_\_\_\_\_  
Original Survey No. \_\_\_\_\_, Abstract No. \_\_\_\_\_.

C. Diversion Point No. \_\_\_\_\_.

- 1) Watercourse: \_\_\_\_\_.
- 2) Location of point of diversion at Latitude \_\_\_\_\_°N, Longitude \_\_\_\_\_°W, Provide Latitude and Longitude coordinates in decimal degrees, to at least six decimal places, and indicate the method used to calculate the diversion point location..  
  
also bearing \_\_\_\_\_° \_\_\_\_\_, \_\_\_\_\_ feet  
(distance) from the \_\_\_\_\_ corner of the \_\_\_\_\_ Original  
Survey No. \_\_\_\_\_, Abstract No. \_\_\_\_\_, County, Texas.
- 3) Location from County Seat: \_\_\_\_\_ miles in a \_\_\_\_\_ direction from  
\_\_\_\_\_, \_\_\_\_\_ County, Texas.  
Location from nearby town (if other than County Seat): \_\_\_\_\_ miles in a \_\_\_\_\_  
direction from \_\_\_\_\_, a nearby town shown on county  
highway map.
- 4) Zip Code: \_\_\_\_\_
- 5) The diversion will be (check (√) all appropriate boxes and if applicable, indicate whether existing or proposed):

	Existing	Proposed
Directly from stream		
From an on-channel reservoir		
From stream to an off-channel reservoir		
From a stream to an on-channel reservoir		
From an off-channel reservoir		
Other method (explain fully, use additional sheets if necessary)		

6) Rate of Diversion (Check (√) applicable provision):

\_\_\_ 1. Diversion Facility:

- A. \_\_\_\_\_ Maximum gpm (gallons per minute)
- B. \_\_\_\_\_ Number of pumps
- C. \_\_\_\_\_ Type of pump
- D. \_\_\_\_\_ gpm, Pump capacity of each pump

E. Portable pump \_\_\_\_\_ Yes or \_\_\_\_\_ No.

\_\_\_2. If by gravity:

A. \_\_\_ Headgate \_\_\_\_\_ Diversion Dam \_\_\_\_\_ Maximum gpm

B. \_\_\_ Other method (explain fully - use additional sheets if necessary)

\_\_\_\_\_  
\_\_\_\_\_

7) The drainage area above the diversion point is \_\_\_\_\_ acres or \_\_\_\_\_ square miles.

D. Return Water or Return Flow (location and quantity information, provide Latitude and Longitude coordinates in decimal degrees to at least six decimal places and indicate the method used to calculate the diversion point location):

Water which is diverted but not consumed as a result of the above stated use, will be returned to

\_\_\_\_\_, tributary of \_\_\_\_\_

\_\_\_\_\_, tributary of \_\_\_\_\_,

\_\_\_\_\_ Basin, at a point which is at Latitude \_\_\_\_\_

\_\_\_\_\_, °N, Longitude \_\_\_\_\_ °W, also, bearing

\_\_\_\_\_ ° (direction), \_\_\_\_\_ feet (distance) from the

\_\_\_\_\_ corner of the \_\_\_\_\_ Original Survey

No. \_\_\_\_\_, Abstract No. \_\_\_\_\_, in \_\_\_\_\_ County, Texas.

Zip Code: \_\_\_\_\_

Estimated **annual** amount of return flow to said stream will be \_\_\_\_\_ acre-feet.

E. Surplus Water (provide Latitude and Longitude coordinates in decimal degrees to at least six decimal places and indicate the method used to calculate the diversion point location):

Water which is diverted but not used beneficially will be returned to \_\_\_\_\_,

tributary of \_\_\_\_\_, \_\_\_\_\_ Basin at a point

which is at Latitude \_\_\_\_\_ °N, Longitude \_\_\_\_\_ °W, also

bearing \_\_\_\_\_ ° (direction), \_\_\_\_\_ feet

(distance) from the \_\_\_\_\_ corner of the \_\_\_\_\_ Original Survey

No. \_\_\_\_\_, Abstract No. \_\_\_\_\_, in \_\_\_\_\_ County, Texas.

Zip Code: \_\_\_\_\_

**4. Discharge Point Information** (if applicable, provide Latitude and Longitude coordinates in decimal degrees to at least six decimal places and indicate the method used to calculate the diversion point location).

Discharge Point No. or Name: \_\_\_\_\_

A. Select the appropriate box for the source of water being discharged:

Treated effluent

Groundwater

Other \_\_\_\_\_

B. Location of discharge point will be/is at Latitude \_\_\_\_\_ ° N, Longitude \_\_\_\_\_ °W,

also bearing \_\_\_\_\_ °, \_\_\_\_\_ feet from the \_\_\_\_\_ corner of the \_\_\_\_\_

Original Survey No. \_\_\_\_\_, Abstract No. \_\_\_\_\_, in \_\_\_\_\_

\_\_\_\_\_ County, Texas.

What method was used to determine the Latitude and Longitude for the discharge point? (*i.e.*, GPS Unit, USGS 7.5 Topographic Map, etc.)

- \_\_\_\_\_
- C. Location from County Seat: \_\_\_\_\_ miles in a \_\_\_\_\_ direction from \_\_\_\_\_, \_\_\_\_\_ County, Texas.  
Location from nearby town (if other than County Seat): \_\_\_\_\_ miles in a \_\_\_\_\_ direction from \_\_\_\_\_, a nearby town shown on county highway map.
- D. Zip Code: \_\_\_\_\_
- E. Water will be discharged into \_\_\_\_\_ stream/reservoir, (tributaries) \_\_\_\_\_, \_\_\_\_\_ Basin.
- F. Water will be discharged at a maximum rate of \_\_\_\_\_ cfs ( \_\_\_\_\_ gpm).
- G. The amount of water that will be discharged is \_\_\_\_\_ acre-feet per year.
- H. The purpose of use for the water being discharged will be \_\_\_\_\_.
- I. Additional information required:

For groundwater

- 1) Provide water quality analysis and 24 hour pump test for the well if one has been conducted.
- 2) Locate and label the groundwater well(s) on a USGS 7.5 Minute Topographic Map
- 3) Provide a copy of the groundwater well permit if it is located in a Groundwater Conservation District.
- 4) What aquifer the water is being pumped from?

For treated effluent

- 1) What is the TPDES Permit Number? Provide a copy of the permit.
- 2) Provide the monthly discharge data for the past 5 years.
- 3) What % of treated water was groundwater, surface water?
- 4) If any original water is surface water, provide the base water right number.

## 5. General Information.

- A. The proposed \_\_\_\_\_ or existing \_\_\_\_\_ works will be (are) located on the land of \_\_\_\_\_, whose mailing address is \_\_\_\_\_
- B. If an application for the appropriation is granted, either in whole or in part, construction works will begin within \_\_\_\_\_ after such permit is issued. The proposed work will be completed within \_\_\_\_\_ from the date the permit is issued.
- C. A Water Conservation Plan is attached? \_\_\_\_\_ Yes \_\_\_\_\_ No.
- D. \_\_\_\_\_ Interbasin transfer is not requested.  
\_\_\_\_\_ Applicant requests authorization to transfer \_\_\_\_\_ acre-feet of water per year from the \_\_\_\_\_ Basin to the \_\_\_\_\_ Basin of which



\_\_\_\_\_ acre-feet of water will be used for \_\_\_\_\_ purposes and  
\_\_\_\_\_ acre-feet of water will be used for \_\_\_\_\_ purposes.

- E. \_\_\_\_\_ Bed and Banks request to transfer \_\_\_\_\_ acre-feet of water per year within the bed and banks of \_\_\_\_\_, tributary of \_\_\_\_\_, \_\_\_\_\_ Basin.
- F. Is this project located within 200 river miles of the coast? \_\_\_\_ Yes \_\_\_\_ No \_\_\_\_ Unknown

**5. Maps, plats, plans, and drawings accompany this application as required by applicable TAC Sections.**

\_\_\_\_\_ Yes \_\_\_\_ No. Attach additional sheets.

6. \_\_\_\_\_ The dam(s) and reservoir(s) shown on the attached application was (were) constructed for domestic and livestock purposes and I/we elect to seek a permit under Section 11.143 of the Texas Water Code.
7. Provide information describing how this application addresses a water supply need in a manner that is consistent with the state water plan or the applicable approved regional water plan for any area in which the proposed appropriation is located or, in the alternative, describe conditions that warrant a waiver of this requirement.

---

---

---

\_\_\_\_\_  
Applicant Name (Sign)

\_\_\_\_\_  
Applicant Name (Sign)

\_\_\_\_\_  
Applicant Name (Printed)

\_\_\_\_\_  
Applicant Name (Printed)

SWORN TO AND SUBSCRIBED before me this \_\_\_\_\_ day of \_\_\_\_\_, 20\_\_\_\_\_.

\_\_\_\_\_  
Notary Public for the State of Texas

## Supplemental Dam/Reservoir Information Sheet

### Dam (structure), Reservoir and Watercourse Data

A. Type of Storage Reservoir (indicate by checking (√) all applicable)

on-channel    off-channel    existing structure    proposed structure\*    exempt structure\*\*

\* Applicant shall provide a copy of the notice that was mailed to each member of the governing body of each county and municipality in which the reservoir, or any part of the reservoir, will be located as well as copies of the certified mailing cards.

\*\* TWC Section 11.143 for uses of water for other than domestic, livestock, or fish and wildlife from an existing, exempt reservoir with a capacity of 200 acre-feet or less. Please complete Paragraph 6 below if proceeding under TWC 11.143.

Date of Construction \_\_\_\_\_

B. Location of Structure No. \_\_\_\_\_.

1) Watercourse: \_\_\_\_\_

2) Location from County Seat: \_\_\_\_ miles in a \_\_\_\_ direction from \_\_\_\_\_,  
\_\_\_\_\_ County, Texas.

Location from nearby town (if other than County Seat): \_\_\_\_ miles in a \_\_\_\_ direction from  
\_\_\_\_\_, a nearby town shown on county highway map.

3) Zip Code: \_\_\_\_\_

4) The dam will be/is located in the \_\_\_\_\_ Original Survey  
No. \_\_\_\_\_, Abstract No. \_\_\_\_\_ in \_\_\_\_\_ County, Texas.

5) Station \_\_\_\_\_ on the centerline of the dam is \_\_\_\_\_° \_\_\_\_\_ (bearing), \_\_\_\_\_ feet  
(distance) from the \_\_\_\_\_ corner of \_\_\_\_\_ Original  
Survey No. \_\_\_\_\_, Abstract No. \_\_\_\_\_, in \_\_\_\_\_ County, Texas, also  
being at Latitude \_\_\_\_\_°N, Longitude \_\_\_\_\_°W.

**Provide Latitude and Longitude coordinates in decimal degrees to at least six decimal places and indicate the method used to calculate the diversion point location**

C. Reservoir:

1) Acre-feet of water impounded by structure at normal maximum operating level: \_\_\_\_\_

2) Surface area in acres of reservoir at normal maximum operating level: \_\_\_\_\_

D. The drainage area above the dam is \_\_\_\_ acres or \_\_\_\_\_ square miles.

E. Other:

1) If this is a U.S. Natural Resources Conservation Service (NRCS) (formerly Soil Conservation Service (SCS)) floodwater-retarding structure, provide the Site No. \_\_\_\_\_ and watershed project name \_\_\_\_\_

2) Do you request authorization to close the "ports" or "windows" in the service spillway?

Yes    No

## Supplemental Dam/Reservoir Information Sheet

### Dam (structure), Reservoir and Watercourse Data

B. Type of Storage Reservoir (indicate by checking (√) all applicable)

on-channel    off-channel    existing structure    proposed structure\*    exempt structure\*\*

\* Applicant shall provide a copy of the notice that was mailed to each member of the governing body of each county and municipality in which the reservoir, or any part of the reservoir, will be located as well as copies of the certified mailing cards.

\*\* TWC Section 11.143 for uses of water for other than domestic, livestock, or fish and wildlife from an existing, exempt reservoir with a capacity of 200 acre-feet or less. Please complete Paragraph 6 below if proceeding under TWC 11.143.

Date of Construction \_\_\_\_\_

B. Location of Structure No. \_\_\_\_\_.

1) Watercourse: \_\_\_\_\_

2) Location from County Seat: \_\_\_\_ miles in a \_\_\_\_ direction from \_\_\_\_\_,  
\_\_\_\_\_ County, Texas.

Location from nearby town (if other than County Seat): \_\_\_\_ miles in a \_\_\_\_ direction from  
\_\_\_\_\_, a nearby town shown on county highway map.

3) Zip Code: \_\_\_\_\_

4) The dam will be/is located in the \_\_\_\_\_ Original Survey  
No. \_\_\_\_\_, Abstract No. \_\_\_\_\_ in \_\_\_\_\_ County, Texas.

5) Station \_\_\_\_\_ on the centerline of the dam is \_\_\_\_\_° \_\_\_\_\_ (bearing), \_\_\_\_\_ feet  
(distance) from the \_\_\_\_\_ corner of \_\_\_\_\_ Original  
Survey No. \_\_\_\_\_, Abstract No. \_\_\_\_\_, in \_\_\_\_\_ County, Texas, also  
being at Latitude \_\_\_\_\_°N, Longitude \_\_\_\_\_°W.

**Provide Latitude and Longitude coordinates in decimal degrees, to at least six decimal places, and indicate the method used to calculate the diversion point location.**

C. Reservoir:

1) Acre-feet of water impounded by structure at normal maximum operating level: \_\_\_\_\_

2) Surface area in acres of reservoir at normal maximum operating level: \_\_\_\_\_

D. The drainage area above the dam is \_\_\_\_ acres or \_\_\_\_\_ square miles.

E. Other:

1) If this is a U.S. Natural Resources Conservation Service (NRCS) (formerly Soil Conservation Service (SCS)) floodwater-retarding structure, provide the Site No. \_\_\_\_\_ and watershed project name \_\_\_\_\_

2) Do you request authorization to close the "ports" or "windows" in the service spillway?

Yes    No

## Supplemental Diversion Point Information Sheet

Diversion Point No. \_\_\_\_\_. (Provide a completed *Supplemental Diversion Point Information Sheet* for additional diversions)

1) Watercourse: \_\_\_\_\_

2) Location of point of diversion at Latitude \_\_\_\_\_°N, Longitude \_\_\_\_\_°W, also, bearing \_\_\_\_\_°, \_\_\_\_\_ feet (distance) from the \_\_\_\_\_ corner of the \_\_\_\_\_ Original Survey No. \_\_\_\_\_, Abstract No. \_\_\_\_\_, in \_\_\_\_\_ County, Texas. **Provide Latitude and Longitude coordinates in decimal degrees, to at least six decimal places, and indicate the method used to calculate the diversion point location.**

3) Location from County Seat: \_\_\_\_\_ miles in a \_\_\_\_\_ direction from \_\_\_\_\_, \_\_\_\_\_ County, Texas.

Location from nearby town (if other than County Seat): \_\_\_\_\_ miles in a \_\_\_\_\_ direction from \_\_\_\_\_, a nearby town shown on county highway map.

4) Zip Code: \_\_\_\_\_

5) The diversion will be (check (√) all appropriate boxes and if applicable, indicate whether existing or proposed):

	Existing	Proposed
Directly from stream		
From an on-channel reservoir		
From stream to an off-channel reservoir		
From a stream to an on-channel reservoir		
From an off-channel reservoir		
Other method (explain fully, use additional sheets if necessary)		

6) Rate of Diversion (Check (√) applicable provision):

\_\_\_1. Diversion Facility:

A. \_\_\_\_\_ Maximum gpm (gallons per minute)

- 1) \_\_\_\_\_ Number of pumps
- 2) \_\_\_\_\_ Type of pump
- 3) \_\_\_\_\_ gpm, Pump capacity of each pump
- 4) Portable pump \_\_\_\_\_ Yes or \_\_\_\_\_ No

\_\_\_2. If by gravity:

A. \_\_\_\_\_ Headgate \_\_\_\_\_ Diversion Dam \_\_\_\_\_ Maximum gpm

B. \_\_\_\_\_ Other method (explain fully - use additional sheets if necessary)

7) The drainage area above the diversion point is \_\_\_\_\_ acres or \_\_\_\_\_ square miles.

## Supplemental Diversion Point Information Sheet

Diversion Point No. \_\_\_\_\_.

1) Watercourse: \_\_\_\_\_

2) Location of point of diversion at Latitude \_\_\_\_\_°N, Longitude \_\_\_\_\_°W, also, bearing \_\_\_\_\_°, \_\_\_\_\_ feet (distance) from the \_\_\_\_\_ corner of the \_\_\_\_\_ Original Survey No. \_\_\_\_\_, Abstract No. \_\_\_\_\_, in \_\_\_\_\_ County, Texas. **Provide Latitude and Longitude coordinates in decimal degrees, to at least six decimal places, and indicate the method used to calculate the diversion point location.**

3) Location from County Seat: \_\_\_\_\_ miles in a \_\_\_\_\_ direction from \_\_\_\_\_, \_\_\_\_\_ County, Texas.

Location from nearby town (if other than County Seat): \_\_\_\_\_ miles in a \_\_\_\_\_ direction from \_\_\_\_\_, a nearby town shown on county highway map.

4) Zip Code: \_\_\_\_\_

5) The diversion will be (check (√) all appropriate boxes and if applicable, indicate whether existing or proposed):

	Existing	Proposed
Directly from stream		
From an on-channel reservoir		
From stream to an off-channel reservoir		
From a stream to an on-channel reservoir		
From an off-channel reservoir		
Other method (explain fully, use additional sheets if necessary)		

6) Rate of Diversion (Check (√) applicable provision):

\_\_\_ 1. Diversion Facility:

A. \_\_\_\_\_ Maximum gpm (gallons per minute)

- 1) \_\_\_\_\_ Number of pumps
- 2) \_\_\_\_\_ Type of pump
- 3) \_\_\_\_\_ gpm, Pump capacity of each pump
- 4) Portable pump \_\_\_\_\_ Yes or \_\_\_\_\_ No

\_\_\_ 2. If by gravity:

A. \_\_\_\_\_ Headgate \_\_\_\_\_ Diversion Dam \_\_\_\_\_ Maximum gpm

B. \_\_\_\_\_ Other method (explain fully - use additional sheets if necessary)

7) The drainage area above the diversion point is \_\_\_\_\_ acres or \_\_\_\_\_ square miles.

## Supplemental Discharge Point Information Sheet

Discharge Point No. or Name: \_\_\_\_\_

1) Select the appropriate box for the source of water being discharged:

- Treated effluent
- Groundwater
- Other \_\_\_\_\_

2) Location of discharge point will be/is at Latitude \_\_\_\_\_ ° N, Longitude \_\_\_\_\_ ° W, also bearing \_\_\_\_\_ ° \_\_\_\_\_, \_\_\_\_\_ feet from the \_\_\_\_\_ corner of the \_\_\_\_\_ Original Survey No. \_\_\_\_\_, Abstract No. \_\_\_\_\_, in \_\_\_\_\_ County, Texas.

**Provide Latitude and Longitude coordinates in decimal degrees, to at least six decimal places and indicate the method was used to determine the Latitude and Longitude for the discharge point? (i.e., GPS Unit, USGS 7.5 Topographic Map, etc.)**

3) Location from County Seat: \_\_\_\_\_ miles in a \_\_\_\_\_ direction from \_\_\_\_\_, \_\_\_\_\_ County, Texas.

Location from nearby town (if other than County Seat): \_\_\_\_\_ miles in a \_\_\_\_\_ direction from \_\_\_\_\_, a nearby town shown on county highway map.

4) Zip Code: \_\_\_\_\_

5) Water will be discharged into \_\_\_\_\_ stream/reservoir, (tributaries) \_\_\_\_\_, \_\_\_\_\_ Basin.

6) Water will be discharged at a maximum rate of \_\_\_\_\_ cfs ( \_\_\_\_\_ gpm).

7) The amount of water that will be discharged is \_\_\_\_\_ acre-feet per year.

8) The purpose of use for the water being discharged will be \_\_\_\_\_.

9) Additional information required:

For groundwater

1. Provide water quality analysis and 24 hour pump test for the well if one has been conducted.
2. Locate and label the groundwater well(s) on a USGS 7.5 Minute Topographic Map
3. Provide a copy of the groundwater well permit if it is located in a Groundwater Conservation District.
4. What aquifer the water is being pumped from?

For treated effluent

1. What is the TPDES Permit Number? Provide a copy of the permit.
2. Provide the monthly discharge data for the past 5 years.
3. What % of treated water was groundwater, surface water?
4. If any original water is surface water, provide the base water right number.

## Supplemental Environmental Information Sheet

Water right projects have the potential to alter environmental conditions in the state's rivers and streams through flow modification, sediment load alteration, loss of wetlands, and removal of riparian vegetation. The Resource Protection Team assess the effects issuance or amendment of a water right may have on existing instream uses. Instream uses include, but are not limited to, water quality, fish and wildlife habitat, recreation, and freshwater inflows to bays and estuaries.

The following items are suggested guidelines for data to be submitted depending on the nature of the particular application. Please note that *not* all the information identified below is required for the water right application to be considered administratively complete. However, depending on the magnitude and scope of the proposed project, failure to provide requested information for technical review may result in delayed processing times or a recommendation of denial of the application.

---

### ITEMS TO BE PROVIDED FOR ALL APPLICATIONS:

1. USGS 7.5 minute topographic map with all diversion points, discharge points, reservoirs, and/or land to be irrigated clearly indicated.
2. Photographs of the stream at the project area (i.e., diversion point/dam location) including upstream and downstream views. Photographs should be in color and reflect the existing conditions of the stream and the riparian vegetation. Each photograph should include a description of what is depicted as well as be referenced to the USGS topographic map indicating the location and direction of the shot.
3. Brief description of the affected stream or water body at the project location including:
  - a) Average and maximum channel width and depth;
  - b) Flow characteristics of the stream (i.e., is the stream perennial, intermittent with pools, or intermittent?);
  - c) Description of land uses upstream within the watershed, if known.
4. Any known recreation or other public uses of the affected stream or water body.

---

### ADDITIONAL ITEMS TO BE PROVIDED IF AN EXISTING DAM AND RESERVOIR ARE SOUGHT TO BE PERMITTED:

1. Date dam constructed.
2. Will the reservoir be maintained at normal pool elevation with an alternate source of water? If so, identify the source of water. If groundwater will be used, see below.
3. Does the dam have an operational low flow outlet or other means to pass state water?

---

### MINIMAL ADDITIONAL ITEMS TO BE PROVIDED IF A DAM AND RESERVOIR ARE PROPOSED TO BE CONSTRUCTED:

1. In addition to indicating the location of the project location on the USGS topographic map, please identify the area of lake inundation at normal pool level.
2. Provide a brief description of the area to be affected by the proposed dam and reservoir.
3. The local U.S. Army Corps of Engineers (USACE) district should be notified of the proposed project. If the USACE determines that a 404 permit is required, provide the project number and name of the USACE Project Manager.

4. Will the reservoir be maintained at normal pool elevation with an alternate source of water? If so, identify the source of water. If groundwater will be used, see below.
5. Will the dam have a low flow outlet or other means to pass state water?

---

**POSSIBLE ADDITIONAL ITEMS TO BE PROVIDED IF A DAM AND RESERVOIR ARE PROPOSED TO BE CONSTRUCTED:**

1. A quantitative or qualitative evaluation of existing aquatic, riparian, wetland, and terrestrial habitats that will be subject to impact by the proposed reservoir project, preferably performed by a qualified third party. Acceptable evaluation procedures to be used may include, but are not limited to, USFWS's Habitat Evaluation Procedures or TPWD's Wildlife Habitat Appraisal Procedure. Any habitat evaluation should include an assessment of the effects of the project on habitats in the river segment downstream.
2. Description of the alternatives that were examined to meet the water needs that the proposed project is intended to fulfill. Were other site locations examined that may result in less environmental impact? How was the size of the proposed reservoir determined? Would a smaller reservoir be adequate to meet the projected water needs? Habitat mitigation shall be considered only after the complete sequencing (avoidance, minimization or modification, and compensation/replacement) process has been performed.
3. Should habitat losses be found to be unavoidable, a mitigation plan should be developed that will compensate for lost or altered ecosystem functions and values imposed by the proposed project. This plan should address both the direct and indirect impacts to aquatic, riparian, and terrestrial habitats, as well as short- and long-term effects that may result from the proposed project. Habitat mitigation plans shall be ensured through binding legal contracts or conservation easements and shall include goals and schedules for completion of those goals. Mitigation areas shall be managed in perpetuity by a party approved by the Commission to maintain the habitat functions and values that will be affected by the proposed project.

---

**ADDITIONAL ITEMS TO BE PROVIDED IF GROUNDWATER WILL BE USED:**

Information regarding the groundwater wells to be used in this project and groundwater quality data from each well to be used. Well information should include the following:

- a) Depth of well;
- b) Name of aquifer from which water is withdrawn;
- c) Pumping capacity of well.

Water chemistry information should include but not be limited to the following parameters:

- a) Chlorides;
- b) Sulfates;
- c) Total Dissolved Solids (TDS);
- d) pH;
- e) Temperature.

If data for on-site wells are unavailable, historical data collected from similar sized wells drawing water from the same aquifer may be provided. However, please note that on-site data may still be required when it becomes available.

**Alternatives Analysis Worksheet for Wetland Impacts**



1. Alternatives
  1. How could you satisfy your needs in ways which do not affect wetlands?
  2. How could the project be re-designed to fit the site without affecting wetlands?
  3. How could the project be made smaller and still meet your needs?
  4. What other sites were considered?
    1. What geographic area was searched for alternative sites?
    2. How did you determine whether other non-wetland sites are available for development in the area?
  5. What are the consequences of not building the project?
  
2. Comparison of alternatives
  1. How do the costs for the alternatives considered above?
  2. Are there logistic (location, access, transportation, etc.) factors that limit the alternatives considered?
  3. Are there technological limitations for the alternatives considered?
  4. Are there other reasons certain alternatives are not feasible?
  
3. If you have not chosen an alternative which would avoid wetland impacts, explain:
  1. Why your alternative was not selected?
  2. What you plan to do to minimize adverse effects on the wetlands impacted?
  
4. Please provide a comparison of each criterion (from Part II) for each site evaluation in the alternatives analysis.

**PERMIT APPLICATION COMPLETION CHECKLIST FOR  
HYDROLOGY, WATER CONSERVATION, AND DAM SAFETY**

Name(s) of Applicant:

Stream, Basin, and County:

USGS 7.5 minute topographic map with all diversion points, discharge points, reservoirs, and/or land to be irrigated clearly indicated:

Latitude and Longitude of all diversion points and/or reservoirs, including how the coordinates were determined:

Diversion amount:

Diversion rate:

Monthly Diversion Distribution (the amount of the total water that you plan to divert each month):

    J    F    M    A    M    J    J    A    S    O    N    D    

Reservoir capacity and surface area:

Drainage area:

Request to use the bed and banks of a watercourse and/or reservoir:

Other (copy of contract for water, alternate source of water, accounting plan, etc.)

**WATER CONSERVATION PLAN**

1. Plan and appropriate data form
2. Please specify the quantitative goals as outlined on the data form

**DAM SAFETY**

If a reservoir is requested in the application, the following information should be submitted:

1. Surface area and capacity of the reservoir
2. Plans (with engineer's seal) for the reservoir if the dam is over 6 feet high
3. Engineer's signed and sealed hazard classification
4. Statement from engineer that the structure complies with the Chapter 299 Rules and supporting documentation

April 5, 2011

Ms. Connie Townsend, P.E.  
Project Manager - Regions E, J, &M  
Water Resources Planning Division  
Texas Water Development Board  
1700 North Congress Ave.  
Austin, Texas 78701

*Re: Final Regional Water Supply Facilities Plan Report - Hidalgo County, Texas  
TWDB Contact No. 0804830848*

Dear Ms. Townsend,

Submitted are six hard copies with diskettes of the final Regional Water Supply Facilities Plan Report. The final report addressed TWDB's comments to the draft plan report outlined in a letter to Mr. Godfrey Garza, Jr., District Manager of Hidalgo County Drainage District No.1, dated February 14, 2011. Our responses to the TWDB's comments are summarized in a memorandum which is included as an attachment to this letter.

Should you have any questions or need additional information, please contact me at (713) 782-3811.

Sincerely,



Deren Li, Ph.D., P.E., D.WRE, CFM  
President



Enclosures

c: Godfrey Garza, Jr., District Manager of Hidalgo County Drainage District No.1

# Memorandum

To: Connie Townsend, P.E.

From: Deren Li, PhD, P.E., D.WRE, CFM

Date: April 4, 2011

Re: Responses to TWDB Review Comments on Draft Report of Regional Water Supply Facilities Plan (Feb 14, 2011)  
TWDB Contract No. 0804830848

---

The following responses are provided for the TWDB review comments for the Regional Water Supply Facilities Plan Draft Report, dated July 2010. The comments were provided by a letter from the Texas Water Development Board to Hidalgo County Drainage District No. 1 on February 14, 2011. For ease of review we have provided verbatim the comments in italics followed by our responses in normal font.

All editorial and substantive technical comments are addressed here and incorporated in the final report.

## Level 1 Comments

1. *Comment: Please provide documentation in the final report for contract Scope of Work Task 2 (Public Involvement)*

Response: Public Involvement aspects of this project has been documented in the Section - Public Involvement of Chapter 1

2. *Comment: In several instances, this draft report refers to data in the draft Region M water plan. Many of these numbers were incorrect in the draft plan or otherwise significantly revised in the final plan. Please revise the final report on the following pages so that references are to numbers contained in the final Adopted Region M plan, which can be located online at [http://www.twdb.state.tx.us/wrpi/rwp/3rdRound/2011\\_RWP/RegionM/](http://www.twdb.state.tx.us/wrpi/rwp/3rdRound/2011_RWP/RegionM/)*

a) *Page 1-1, Column 1, paragraph 2; and Page 3-9, Table 3-1: The projected Hidalgo County municipal water surplus/needs volumes. Please see plan Section 4.2.1.2, page 4-9, Table 4.5: Hidalgo County projected gross sum of municipal WUG deficits is 3,276 ac-ft/yr in 2010; projected to increase to a deficit of 139,939 ac-ft/yr by 2060.*

Response: The report text on Page 1-1 and the Table 3-1 have been updated to reflect the values in the 2011 Region M Regional Water Plan.

b) *Page 1-2, Column 1, paragraph 1: The City of Elsa projects no shortages in the Region M plan; please see plan Section 4.2.1.2, page 4-9, Table 4.5.*

Response: The City of Elsa has been removed from the text in reference to projected water shortages.

- c) *Page 1-2, Column 1, paragraph 3: The year 2060 projected population stated for Hidalgo County does not appear to match this draft report's page 3-3, paragraph 1, as well as the Region M plan. Please see plan 2<sup>nd</sup> Errata Sheet, page 7 of 42, Replacement Table 2.2.*

Response: The report text has been updated to match the 2011 Region M Regional Water Plan population projections.

- d) *Page 1-2, Column 1, paragraph 3: The stated 50-year increase in municipal water needs. Please see plan Section 4.2.1.2, page 4-9, Table 4.5: the 136,654 ac-ft/yr increase between 2010 and 2060 corresponds to a 41.7-fold increase.*

Response: The report text has been updated to reflect the 2011 Region M Regional Water Plan projections.

- e) *Page 1-2, Column 2, paragraph 2: The water management strategy status of the HCDD #1 project. Please see plan Section 4.9.1, page 4-104, which states the planning group considered, but did not evaluate the HCDD #1 project due to the preliminary status of the project and lack of pertinent information.*

Response: The report text has been amended to reflect the correct language used in the 2011 Region M Regional Water Plan.

- f) *Page 3-3, Column 1, paragraph 2: Hidalgo County summary net water demands for municipal, manufacturing, steam-electric, mining, and livestock. Please see plan Section 2.3: 131,124 ac-ft/yr in 2010 and 313,577 ac-ft/yr in 2060 for a 139% increase.*

Response: The report text has been updated to reflect the 2011 Region M Regional Water Plan projections.

- g) *Page 3-3, Column 1, paragraph 2: Hidalgo County net water demands for irrigation. Please see plan Section 2.3: 560,291 ac-ft/yr in 2010 and 436,074 ac-ft/yr in 2060 for a 22% decrease.*

Response: The report text has been updated to reflect 2011 Region M Regional Water Plan projections.

- h) *Page 3-3, Column 1, paragraph 2: Hidalgo County net municipal water demands. Please see plan Section 2.3: 115,410 ac-ft/yr in 2010 and 278,964 ac-ft/yr in 2060 for a 142% increase.*

Response: The report text has been updated to match the 2011 Region M Regional Water Plan projections.

- i) *Page 3-3, Column 1, paragraph 3: Surplus/Deficit volumes for McAllen, Mission, and total for Hidalgo County. Please see plan Section 4.2.1.2, page 4-9, Table 4.5: needs are 29,457 ac-ft/yr, 19,674 ac-ft/yr, and 139,930 ac-ft/yr, respectively.*

Response: The report text has been updated to match the 2011 Region M Regional Water Plan projections.

- j) *Page 3-3, Column 2, last paragraph; Pages 8-2 and 8-3: The proposed project is not a recommended or alternative water management strategy. Please see plan Section 4.9.1, page 4-104. Please provide a notation in these two sections of the final report to state that for any funding to be available from the TWDB, the proposed project will need to be added as a viable water management strategy in the "2011 Adopted Region M Regional Water Plan" or will require support from the Region M Water Planning Group for a consistency waiver.*

Response: The report text has been updated to include the specified notations under the Section - Potential Funding Sources on Page 8-3.

- k) *Page 3-4, Column 2, paragraph 3: total deficit for Hidalgo County. Please see plan Section 4.2.1.2, page 4-9, Table 4.5: 2030 needs = 38,126 ac-ft/yr.*

Response: The report text has been updated to match the 2011 Region M Regional Water Plan projections.

3. *Page 1-1, Column 1, paragraph 2: Please clarify in the final report how conversion of irrigation water rights to municipal water rights decreases water availability to the county.*

Response: The conversion of irrigation water rights to domestic, municipal and industrial rights also reduces total water availability to the county. The conversion could reduce return flows that could potentially be used by downstream water users. As mentioned in Section 5.2 of the 2011 Region M Regional Water Plan, it takes a minimum 2 acre-feet of irrigation water rights to convert to 1 acre-feet of municipal water rights in the region. The report has been updated to provide clarification. The report text has been updated to clarify the water conversion issue.

4. *Page 1-1, Column 2, paragraph 2; and Page 1-2, Column 2, paragraph 2: Water sources listed for water collected in the district's drainage canals appears to be missing discussion on contributions from Rio-Grande agricultural irrigation runoff (tailwater) as well as potential overflow directly into the drainage canals from the Rio-Grande during flood conditions. Please clarify in the final report where appropriate.*

Response: The report text reflects that stormwater runoff and shallow groundwater are the main water sources within the drainage system. The proposed project location within the North Main Drain watershed does not receive flood water from the Rio Grande River during normal flood events.

5. *Page 1-4, Figure 1-1: It appears that delineation is missing between district-owned drainage canals and the floodway canals owned by the IBWC and others. In the final report, please identify these other drainage networks separately and add to the figure legend.*

Response: The report Figure 1-1 has been updated accordingly to distinguish between HCDD No. 1 and non-HCDD No.1 streams.

6. *Page 2-1, Column 1, paragraph 2; and Page 2-1, Column 2, paragraphs 2 and 3: It appears there is a conflict in these 2 paragraphs regarding the types of water that are considered waters of the state, specifically stormwater. In the final report, please clarify this information and reconcile if appropriate. Also please provide the missing references for the various State water regulations paraphrased in this chapter.*

Response: The report text has been modified to clarify the difference between state water and non-state water with regards to concentrated flow and stormwater runoff (sheet flow). Reference to the appropriate section of The Texas Water Code regarding water rights was made in the report.

7. *Page 2-1, last paragraph; and Page 2-2, first paragraph: Please provide the specific reference from the "2011 Adopted Region M Regional Water Plan"*

Response: The report text has been updated to include the specific reference.

8. *Page 2-2, paragraph 2; Figure 2-1; and Page 3-4, paragraph 2: Please provide the actual square mileage of the North Main Drain Watershed and the percentage of this area that would likely be able to contribute rainfall runoff for stormwater flows.*

Response: The report text (see Section - Project Water Rights) has been updated to provide information on contributing watershed areas. The narrative now indicates that the North Main Drain Watershed is 444 square miles and the percentage of area contributing stormwater runoff ranges from 59 percent to 91 percent depending on the location of the project site.

9. *Task 3 (Water Rights and Permit Applications) of this study had not been performed at the time the draft report was submitted to the TWDB. Please revise all of Chapter 2 in the final report with the information required to document in detail the process of the thorough legal investigation and the coordination with the TCEQ on water rights for the project area as well as the permit process that appears will eventually be required by the TCEQ in order for the HCDD #1 to be granted authorization to utilize the waters in the specified district canals.*

Response: The report text in Chapter 2 has been revised accordingly.

10. *Page 3-8, Figure 3-4: The CCN service area boundaries for each water utility appear to be missing in Figure 3-4 and its legend (as referenced in text on page 3-4, column 2 of the draft report). Please include in final report.*

Response: Figure 3-4 of the report has been updated to reflect the missing CCN service areas.

11. *Chapter 4, Site II Analysis: The proposed Floodwater Detention Basin is in the 100-year floodplain and the development will take out a substantial amount of floodplain. In the final report, please include discussion of measures that may be taken to mitigate this impact.*

Response: The proposed floodwater detention basin will provide net benefit to floodplain storage with implementation of the project at Site II. Additional narrative has been provided in the text to address potential impacts being mitigated within the proposed floodwater detention basin volume.

12. *Chapter 5: In the final report, please clarify whether or not the Floodwater Detention Basin will include a screen at the discharge to the Wet Well and Raw Water Storage Basin.*

Response: Screening facilities are required at the Floodwater Detention Basin discharging to the Wet Well and Raw Water Storage Basin.

13. Chapter 6: In the final report, please document the analysis process for the treatment facility flocculation/sedimentation option.

Response: Analysis process for the flocculation/sedimentation processes are discussed in Section - Water Treatment Technologies.

The water supply source for this project is from the storm water drainage ditch. Even though the turbidity is measured between 11 and 60 NTU (Table 6-1), the nature of suspended solids during flood events, is expected much higher than 60 NTU. Particles in the raw water supply also include colloids, dissolved solids, bacteria, and other organisms. The chemical characteristics of the raw water supply required more efficient formations of larger particles in the coagulation and flocculation process.

The primary parameter used for conventional sedimentation basin design is the acceptable hydraulic overflow rate. The typical range of hydraulic over flow rates for sedimentation of solids produced through alum coagulation/flocculation are 800 to 1200 gallon per day (gpd) per square foot (ft<sup>2</sup>).

The principal types of high-rate clarification processes considered are:

- Tube settlers
- Plate settlers
- Sludge blanket clarifier
- Ballasted flocculation (ACTIFLO)

High-rate Clarifier Unit	Definitions	Hydraulic Overflow Rate, gpd/ft <sup>2</sup>
Tube settlers	The first tube settlers were introduced in the 1960s by Microfloc, which take advantage of the theory that surface overflow loading	2,880, or 4 times of conventional sedimentation basin
Plate settlers	Platte settlers date back to an English patent in 1886 (Purac) and were developed in the 1950s in drinking water	2,880 to 8,640, or 4 to 12 times of conventional sedimentation basin
Sludge blanket clarifier (Superpulsator)	The original Pulsator Clarifier was developed in the early 1950s, and designed to provide uniform upward flow	2,880 to 7,200, or 4 to 10 times of conventional basin
Ballasted flocculation (ACTIFLO)	Patented package unit developed by Kruger, and designed to combine the plate settlers and ballasted flocculation	21,600 to 28,800, or 30 to 40 times of conventional basin

ACTIFLO has more than 30 times of the conventional sedimentation basins' hydraulic overflow rate. Using ACTIFLO will significantly reduce construction costs for the project.

14. Chapter 6: In the final report, please document the mineral and contaminant analysis process performed on the six treatment alternatives

Response: See response to Comment 15.



15. Chapter 6: In the final report, please document the calculations used for the water quality analysis of the six treatment alternatives.

Response: The removal of contaminants can be cost-effectively achieved by DMF process. ACTIFLO can effectively remove suspended solids. Membrane process (RO or NF) is very effective in removing dissolved solids. It seems that a combination of the above treatment processes is necessary to achieve the treated water targets. A flow diagram was developed in the treatment process selection for this project. The report text in Chapter 6 has been updated accordingly.

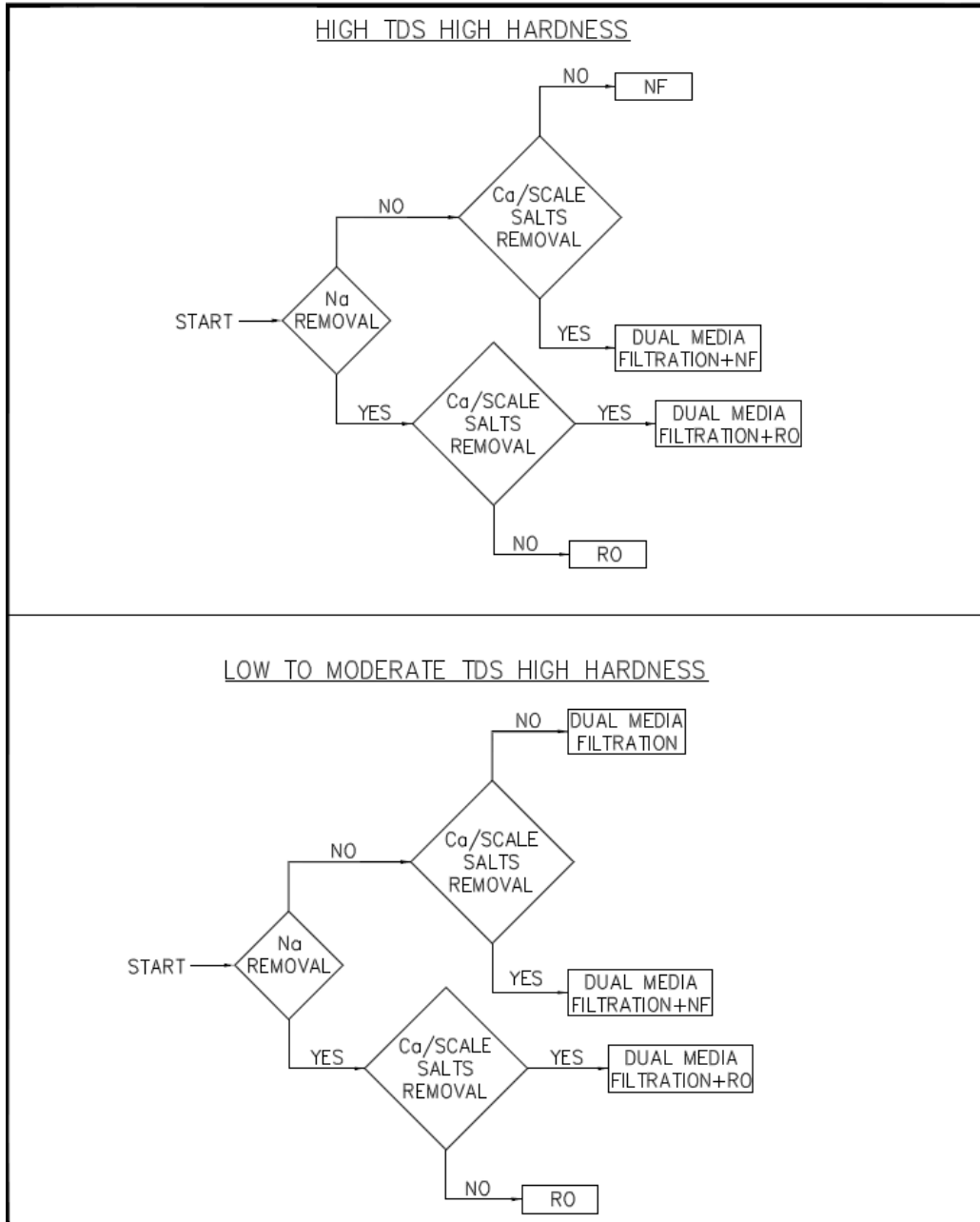

16. *Chapter 7: In the final report, please document the conceptual process trains proposed for the blending option for alternatives A, B, C, and D that are discussed in Chapter 8.*

Response: Discussion of blending for alternatives C and D is provided in Chapter 7. To minimize the initial capital expenditures and annual O & M costs, the blending of DMF discharge with NF treated water for Alternative C and blending of DMF discharge with RO treated water for Alternative D are recommended. The treated water blending ratio for alternatives C and D are generally governed by the amounts of salinity water concentrations at DMF discharge and either NF or RO treated water and the acceptable levels of TDS established for public water supplies. In general, the acceptable levels of TDS are ranged from 500 to 1,000 mg/L. Pilot testing is recommended to identify the cost-effective alternative. The report text in Chapter 7 has been updated accordingly.

17. *Chapter 8: In the final report, please document the blending requirements of the reverse osmosis treatment system for public water supplies.*

Response: Potential blending requirements of the RO treatment system is discussed in Chapter 8. To minimize the initial capital expenditures and annual O & M costs, the blending of DMF discharge with NF treated water for Alternative C and blending of DMF discharge with RO treated water for Alternative D are recommended. The treated water blending ratio for alternatives C and D are generally governed by the amounts of salinity water concentrations at DMF discharge and either NF or RO treated water and the acceptable levels of TDS established for public water supplies. In general, the acceptable levels of TDS are ranged from 500 to 1,000 mg/L. Pilot testing is recommended to identify the most cost-effective alternative. The report text in Chapter 8 has been updated accordingly.

## Level 2 Comments

1. *Please ensure that the final report is printed double-sided per Section II., Article 3, Item 4 of the contract.*

Response: The final report has been printed accordingly.

2. *Please add a listing for the Executive Summary to the Table of Contents in the final report.*

Response: The report has been updated accordingly.

3. *Page 1-1, Column 2 refers to "Figure 1". Please correct this to Figure 1-1 (page 1-4).*

Response: The report has been updated accordingly.

4. *Throughout the final report, please revise references from the "TWDB" Regional Water Plans to the appropriate version of the "Rio Grande" or "Region M" Regional Water Plan. Regional water plans are developed by each of the 16 Regional Water Planning Groups, not TWDB. Examples include pages 2-1, 2-2, and 3-2.*

Response: Comment noted. The report has been updated accordingly.

5. *Page 2-1, Column 2, paragraph 2: The status of municipal water rights are in continual process of change as irrigation water rights are purchased and converted to municipal water rights over time. In the final report please revise the sentence "The total municipal water rights in the county are currently..."; to "The total municipal water rights in the county at that time were...".*

Response: Comment noted. The report has been updated accordingly.

# Regional Water Supply Facilities Plan



prepared by



April 2011

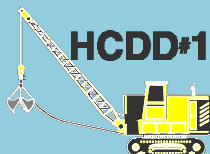

## Table of Contents



### Executive Summary

#### Chapter 1 Introduction

Background .....	1-1
Project Need .....	1-2
Purpose and Objectives .....	1-2
Study Guiding Principles .....	1-3
Public Involvement .....	1-3

#### Chapter 2 Water Rights

Texas Water Rights Regulations....	2-1
Project Water Rights .....	2-2
Legal Investigations and Coordination .....	2-2

#### Chapter 3 Water Supply And Demand Analysis

HCDD No.1 and Hidalgo County Master Drainage Systems .	3-1
Water Supply.....	3-2
Water Demand .....	3-3
Water Needs.....	3-3
Development Opportunity.....	3-3

Current Water Supply Network and Service Areas .....	3-4
---	-----

#### Chapter 4 Siting Analysis

Water Availability .....	4-1
Components of Raw Water Conveyance Systems.....	4-2
Site I .....	4-3
Site II.....	4-4
Site III .....	4-4

#### Chapter 5 Raw Water Conveyance Systems

Weir Structure .....	5-1
Intake Inlet .....	5-1
Wet Well .....	5-1
Pump Stations .....	5-1
Raw Water Storage Basin .....	5-1
Floodwater Detention Basin.....	5-2
Operating Strategy of RWSB and FWDB.....	5-2
Water Quality Monitoring System .	5-2

**Chapter 6**  
**Treatment Process Evaluation**

Source Water Quality ..... 6-1  
Finished Water Targets ..... 6-5  
Water Treatment Technologies ..... 6-9  
Alternative Treatment Processes.. 6-32

**Chapter 7**  
**Conceptual Design**

Alternative A ..... 7-1  
Alternative B ..... 7-1  
Alternative C ..... 7-2  
Alternative D ..... 7-2  
Alternative Building Layouts ..... 7-2

**Chapter 8**  
**Cost Analysis**

Methodology ..... 8-1  
Itemized Cost Estimates..... 8-2  
Annual Costs ..... 8-2  
Potential Funding Sources ..... 8-2

**Chapter 9**  
**Summary, Conclusions,**  
**And Recommendations**

Summary ..... 9-1  
Conclusions ..... 9-2  
Recommendations ..... 9-2

## List of Figures

Figure 1-1. Hidalgo County and Hidalgo County Drainage District No.1 .....	1-4
Figure 2-1. North Main Drain Drainage Basin Delineations .....	2-3
Figure 3-1. Hidalgo County Master Drainage Systems .....	3-5
Figure 3-2. Base Flow Measurement Locations .....	3-6
Figure 3-3. Stream Gauge Stations .....	3-7
Figure 3-4. Current Water Supply Network and Service Areas .....	3-8
Figure 4-1. Potential Project Sites .....	4-6
Figure 4-2. FEMA Effective 100-Year Floodplain.....	4-7
Figure 4-3. Stream Gauge Data ( Sep. 29, 2008 - Set. 30, 2009) .....	4-8
Figure 4-4. Synthetic Hydrographs .....	4-9
Figure 4-5. SITE I Facilities Plan Layout .....	4-10
Figure 4-6. SITE II Facilities Plan Layout .....	4-11
Figure 4-7. SITE III Facilities Plan Layout .....	4-12
Figure 5-1. Intake Structures and Design Data at SITE I .....	5-3
Figure 5-2. Intake Structures and Design Data at SITE II .....	5-4
Figure 5-3. Intake Structures and Design Data at SITE III .....	5-5
Figure 5-4. Raw Water Storage Basin .....	5-6
Figure 5-5. Pump Station II .....	5-7
Figure 6-1. Source Water Sampling Locations .....	6-3
Figure 6-2. ACTIFLO Process .....	6-11
Figure 6-3. Pressure-Driven Membrane Process Application Guide.....	6-15
Figure 6-4. Effective of Pressure-Driven Membrane Processes .....	6-16
Figure 6-5. Chlorine System Layout.....	6-22
Figure 6-6. UV Disinfection Unit .....	6-23
Figure 6-7. Residual Handling Process for a 10 MGD WTP .....	6-26
Figure 6-8. Chemical Feed System for a 10 MGD WTP .....	6-29
Figure 6-9. WTP Sampling Locations .....	6-31
Figure 6-10. Treatment Process Decision Making Process .....	6-34
Figure 6-11. Schematic of Alternative Treatment Processes .....	6-36
Figure 7-1-1. Conceptual WTP Process Train for Alternative A - DMF.....	7-3
Figure 7-1-2. Conceptual WTP Process Train for Alternative A - DMF.....	7-4
Figure 7-2-1. Conceptual WTP Process Train for Alternative B - NF.....	7-5
Figure 7-2-2. Conceptual WTP Process Train for Alternative B - NF.....	7-6
Figure 7-3-1. Conceptual WTP Process Train for Alternative C - DMF+NF.....	7-7
Figure 7-3-2. Conceptual WTP Process Train for Alternative C - DMF+NF.....	7-8
Figure 7-3-3. Conceptual WTP Process Train for Alternative C - DMF+NF.....	7-9

List of Figures (Cont.)

Figure 7-4-1. Conceptual WTP Process Train for Alternative D - DMF+RO ..... 7-10  
Figure 7-4-2. Conceptual WTP Process Train for Alternative D - DMF+RO ..... 7-11  
Figure 7-4-3. Conceptual WTP Process Train for Alternative D - DMF+RO ..... 7-12  
Figure 7-5. Water Treatment Plant Layout - Long Stretch..... 7-13  
Figure 7-6. Water Treatment Plant Layout - Square..... 7-14  
Figure 7-7. Water Treatment Plant Layout - Radial..... 7-15  
Figure 7-8. Water Treatment Plant Layout - Rectangular ..... 7-16



## List of Tables

Table 3-1. Hidalgo County Projected Municipal Water Surplus and Needs (AF) .....	3-9
Table 6-1. Raw Water Sampling and Water Quality Parameters .....	6-4
Table 6-2. Required TOC Removal .....	6-5
Table 6-3. Cost Comparison for Chlorine Sources .....	6-21
Table 6-4. Cost Comparison for Chlorine and UV System .....	6-21
Table 6-5. Performance of Alternative Water Treatment Processes .....	6-35
Table 8-1. Estimate of Probable Capital Costs - Alternative A	
ACTIFLO + DMF.....	8-4
Table 8-2. Estimate of Probable O&M Costs - Alternative A	
ACTIFLO + DMF .....	8-4
Table 8-3. Estimate of Probable Capital Costs - Alternative B	
ACTIFLO + NF .....	8-5
Table 8-4. Estimate of Probable O&M Costs - Alternative B	
ACTIFLO + NF .....	8-5
Table 8-5. Estimate of Probable Capital Costs - Alternative C	
ACTIFLO + DMF+NF (No Blending) .....	8-6
Table 8-6. Estimate of Probable O&M Costs - Alternative C	
ACTIFLO + DMF+NF (No Blending) .....	8-6
Table 8-7. Estimate of Probable Capital Costs - Alternative D	
ACTIFLO + DMF+RO (No Blending).....	8-7
Table 8-8. Estimate of Probable O&M Costs - Alternative D	
ACTIFLO + DMF+RO (No Blending).....	8-7
Table 8-9. Estimate of Probable Capital Costs - Alternative C	
ACTIFLO + DMF+NF (Blending).....	8-8
Table 8-10. Estimate of Probable O&M Costs - Alternative C	
ACTIFLO + DMF+NF (Blending).....	8-8
Table 8-11. Estimate of Probable Capital Costs - Alternative D	
ACTIFLO + DMF+RO (Blending).....	8-9
Table 8-12. Estimate of Probable O&M Costs - Alternative D	
ACTIFLO + DMF+RO (Blending).....	8-9
Table 8-13. Summary of Estimate of Probable Capital Costs (No Blending).....	8-10
Table 8-14. Summary of Estimate of Probable Annual O&M Costs (No Blending) ....	8-10
Table 8-15. Summary of Estimate of Probable Capital Costs (Blending) .....	8-11
Table 8-16. Summary of Estimate of Probable Annual O&M Costs (Blending) .....	8-11
Table 8-17. Annualized Estimate of Probable Total Costs (No Blending) .....	8-12

List of Tables (Cont.)

Table 8-18. Annualized Estimate of Probable Total Costs (Blending).....8-12

Table 8-19. Annualized Estimate of Probable  
Total Costs (\$/1000 gallon) (No Blending) .....8-13

Table 8-20. Annualized Estimate of Probable  
Total Costs (\$/1000 gallon) (Blending).....8-13

Appendices  
(Attached CD-ROM)

- A. Baseline Environmental Study Report
- B. Raw Water Quality Sampling and Laboratory Analysis Report
- C. National and State Drinking Water Standards
- D. Detailed Cost Estimates
- E. Responses to TWDB Comments on the July 2010 Draft Report

## **EXECUTIVE SUMMARY**

The purpose of this Regional Water Supply Facilities Plan was to identify and evaluate potential project sites, drinking water treatment processes, and facilities required to develop drainage water within the Hidalgo County Drainage District No.1 drainage systems as a potential alternative water source to supply treated water to areas within the Hidalgo County in the near future through 2060. Specific objectives included:

- § Develop a baseline raw drainage water quality conditions
- § Identify and evaluate potential project locations (sites) for diversion, storage, and treatment of the drainage water
- § Develop finished water quality targets by reviewing the current U.S. Environmental Protection Agency (EPA) and Texas Commission in Environmental Quality (TCEQ) drinking water quality standards and regulations
- § Identify and evaluate alternative drinking water treatment technologies and processes
- § Identify and evaluate facilities for raw water diversion, storage, and conveyance
- § Develop conceptual designs for each of the identified treatment processes
- § Develop probable cost estimates for each of the treatment processes and perform cost comparison analysis.

Water quality samples were collected for the raw water from the drainage ditches and water quality parameters were determined by laboratory test analysis. The raw drainage water has a high level of TDS at approximately 2000 mg/L. The water is considered very hard with a hardness of approximately 600 mg/L as CaCO<sub>3</sub>. Also the raw water is brackish with a concentration of Chloride of 400-500 mg/L.

Three potential project sites were identified and evaluated to divert and treat raw drainage water. Each site was evaluated with consideration of availability of dependable water, floodplain, topography, accessibility, land use and land cover, and environmental concerns. Two of the three sites, SITE I and SITE II, are located on the North Main Drain and one site (SITE III) is located on the Main Floodwater Channel. Based on the evaluation with consideration of all the evaluation factors, SITE II and SITE III were recommended for future further investigation. SITE III, located on the Main Floodwater Channel, was considered as the most preferred site which has the most reliable water supply and potential for future expansion. The second preferred site was SITE II which is located on the North Main Drain between SITE I and SITE III.

Facilities related to raw water diversion, storage, and conveyance were proposed. The proposed facilities include a weir structure located just downstream of the diversion intake structure on the drainage ditch to ensure a steady water level for diversion during normal base flow conditions, a diversion intake structure with screen to divert raw water from the drainage ditch to a wet well (concrete vault) via a pipeline by gravity, a pump station (Pump Station I) to lift the raw water from the wet well to a raw water storage basin with a capacity for seven (7) days water supply to reliably water supply the treatment plant, a second pump station (Pump Station II) to provide feed water to the water treatment plant, a floodwater detention basin to store floodwater during wet season and supplement normal base flow drainage water during dry season, a side weir structure

to divert floodwater to the floodwater detention basin via a open channel by gravity, and a pipeline between the floodwater detention basin and the raw water storage basin and a pipe between the floodwater detention basin and wet well to convey floodwater to the raw water storage basin by gravity.

EPA and TCEQ current drinking water standards and rules were extensively reviewed and target finished water quality targets were developed.

Four alternative water treatment processes were identified and evaluated. Both conventional and membrane treatment process units were considered. The four alternative processes are A - ACTIFLO clarification followed by dual media filtration (DMF), B - ACTIFLO clarification followed Nanofiltration (NF) membrane filtration, C - ACTIFLO followed by DMF and NF, and D - ACTIFLO followed by DMF and Reverse Osmosis (RO) membrane filtration. Blending of water from DMF and NF or RO was proposed Alternatives C and D respectively.

Conceptual designs were developed for each of the four alternative treatment processes. Process trains were developed for each alternative processes with conceptual design data, such as tank sizes and numbers required, building sizes, pipe sizes, pump sizes, etc. Also, three alternative building arrangement layouts were developed.

Probable capital costs and annual O&M costs were developed for each alternative treatment process with four (4) treatment capacities. Cost comparison analysis was performed based on annual costs. Annualized capital cost and annual O&M cost were summed to obtain the total annual cost for each alternative and treatment capacity. An interest rate of 6% was assumed for the analysis. Life cycle present value analysis was not performed for the purpose of this study. Costs are presented in 2010 dollars.

Capital costs include construction components such as excavation and site work, equipment, concrete and steel, labor, pipe and valves, power supply access and instrumentation, and housing that are expended in the construction activities of the project, and other expenses such as engineering, engineering service during construction, financial and legal services, permitting, commissioning and startup. The capital costs include a 30 percent contingency, which is appropriate for this level of project definition. The capital costs in this estimate do not include costs for land and rights-of-way.

Based on the annual cost estimates (\$/1000 gallon) and the performance of each alternative treatment process, with consideration of blending treated water from DMF and NF or RO, alternatives C (ACTIFLO+DMF+NF) and D (ACTIFLO+DMF+RO) were identified as the two preferred alternatives. Alternatives A and B were kept as two potential candidates with considering that the potential integration with existing water supply systems were not determined at this stage of the project.

# 1 Introduction

## Background

Hidalgo County is located in the Lower Rio Grande Valley of South Texas, as shown in **Figure 1-1**. It covers 1,583 square miles and is bordered by Cameron and Willacy Counties on the east, Brooks County on the North, Starr County on the west and Mexico on the South with the Rio Grande River forming its border with Mexico. Based on the Texas Water Development Board (TWDB) regional water planning area delineations, Hidalgo County is located within the Rio Grande Regional Water Planning Area (Region M). Also, the majority of the County lies within the Nueces-Rio Grande Coastal Basin.

The Rio Grande is the County's primary source of water. More than 99 percent of the total water supply for the county is associated with water rights to releases from the Amistad/Falcon Reservoir System on the Rio Grande River. Water availability to the county is decreasing from the reduced water yields on Rio Grande due to sedimentation the development and operation of reservoirs on Mexican tributaries that contribute to the Rio Grande. Increased urbanization and the conversion of irrigation water rights to domestic, municipal and industrial rights also reduce the availability of water to the county. The water rights conversion could potentially reduce return flows to be available to downstream water users. According to Section 5.2 of the 2011 Region M Regional Water Plan, it takes a minimum 2 acre-feet of irrigation water



rights to convert to 1 acre-feet of municipal water rights.

From a municipal perspective, the County has a total deficit of over 3,276 acre-feet per year in the year 2010 and this deficit is projected to increase to nearly 139,930 acre-feet per year by 2060 based on projections made by the Texas Water Development Board (TWDB).

The Hidalgo County Drainage District No.1 has jurisdiction over more than 50 percent of Hidalgo County, as shown **Figure 1-1**. It has a desire to investigate potential water supply facilities plans to utilize its existing drainage and flood control systems to capture and treat drainage water (storm water runoff, shallow groundwater discharges and irrigation runoff) within its drainage systems to provide water for beneficial uses within the County. As discussed in the Hidalgo County Water Development Project (2006), the main water sources within the drainage systems are from stormwater and shallow groundwater. HCDD No.1 drainage system does not receive floodwater from Rio Grande River under normal flood events. The primary driving force for this project is to address the severe water shortage

issues facing the County in the near future.

## **Purpose and Objectives**

The ultimate purpose of this project is to assist Hidalgo County Drainage District No.1 (HCDD No.1) to develop drainage water within the district's drainage system as an alternative water source to supply treated water to areas within Hidalgo County in the near future through 2060. Specifically, the objectives of this project include: (1) to identify alternative diversion and storage components of a Regional Water Supply Facilities Plan to capture and store drainage water (rainfall runoff and shallow groundwater) constantly flowing within the existing drainage systems, (2) to evaluate alternative water treatment facilities plans to treat the captured drainage water to drinking water standards to supply the treated water to the potential water users within the County.

The evaluation and development of the facilities plan was based on the water shortfall projections made by the TWDB as presented in the 2011 Region M Regional Water Plan, and the water availability estimates presented in the Hidalgo County Water Development Project Report, September 2006. The proposed water facilities plan will address potential water shortages in the cities of McAllen, Mission, Pharr, Edinburg, Alamo, San Juan, Hidalgo City, Weslaco, and other water user groups such as the North Alamo Water Supply Corporation.

## **Project Need**

Hidalgo County, the largest county in the Texas Rio Grande Valley, is one of the fastest growing counties in the State of Texas. It also located in one of the most economically distressed areas in the State of Texas and the United States.

According to the U.S. Census Bureau, the county's population increased 30 percent from approximately 569,463 in 2000 to 741,152 in 2009. The TWDB (2011 Region M Regional Water Plan) has projected a population of 2,048,911 by year 2060 for Hidalgo County. Municipal water needs for the county are projected to increase more than 41-fold in 50 years. Based on TWDB's projections, both municipal and agricultural water uses in Hidalgo County will face significant shortages through the year 2060.

In response to the future water shortages faced by Hidalgo County, several investigations have been conducted by federal, state, and local agencies for the county and the Rio Grande Valley as a whole. The most comprehensive studies is the 2011 Region M Regional Water Plan prepared by the TWDB. A range of water management strategies were evaluated and recommended to meet future water supply needs, primarily including water conservation, acquisition of existing Rio Grande water rights, reuse of reclaimed water, and desalination of seawater and brackish groundwater.

The opportunity for developing drainage water (rainfall runoff and shallow groundwater) within the HCDD No1 drainage system, specifically this project, was considered as a potential

water management strategy in the 2011 Region M Regional Water Plan but was not evaluated due to the preliminary status of the project and the lack of pertinent information at the time.

The constantly flowing drainage water within the HCDD No.1 drainage system network has long been observed and is believed to be an unexploited alternative water source for the county. In 2006, the district initiated a preliminary investigation on the opportunity to develop the drainage water within its existing drainage system, specifically along the North Main Drain and the Main Floodwater Channel. The conclusions are presented in a report entitled "*Hidalgo County Water Development Project*", HCDD No.1, 2006. It was estimated there is a dependable base flow of 58 cfs in the Main Floodwater Channel, which translates to approximately 42,300 ac-ft/year. Fully development of this amount of water could meet 16 percent of the total projected 2060 water supply need of Hidalgo County or approximately 100 percent of the projected water needs for the Cities of McAllen and Mission in 2060.

Developing the drainage water within the existing drainage system is consistent with the National Economic Development (NED) objective of Water Resources Council's Principles and Standards adopted by Presidential Order in 1973 and revised in 1979, by maximizing the outputs of the County's existing drainage/flood control systems. The use of the existing drainage facilities for multiple purposes (drainage/flood control and water supply) will increase benefits without a proportional increase

in costs and thus enhance the economic justification for the project.

## Study Guiding Principles

The following guiding principles have been followed for the development of this water supply facility plan:

1. Consistency with the objectives of the 2011 Region M Regional Water Plan.
2. Non-compromise of the primary functions of the existing drainage systems to provide outfalls for developments within the county and to provide flood protection.
3. Compatibility with the future mix of water supplies.
4. Cost effectiveness.
5. Minimization of potential adverse environmental impacts.
6. Compliance with federal, state, and local pertinent regulations.

## Public Involvement

Public involvement is an integral part of the project to ensure that the water facilities plan is publically supported. Public involvement activities for this project include two advisory committee meetings/public meetings (October 28, 2008 and December 15, 2009), press releases for the meetings on the local *The Monitor* news paper, broadcast of the meetings on local KMBH-TV, live online of the meetings at [www.co.hidalgo.tx.us/cclive](http://www.co.hidalgo.tx.us/cclive), coordination with TCEQ regarding water rights issues, contacts and discussions with water utility districts regarding potential water users. The project received positive responses by the public and potential stakeholders.



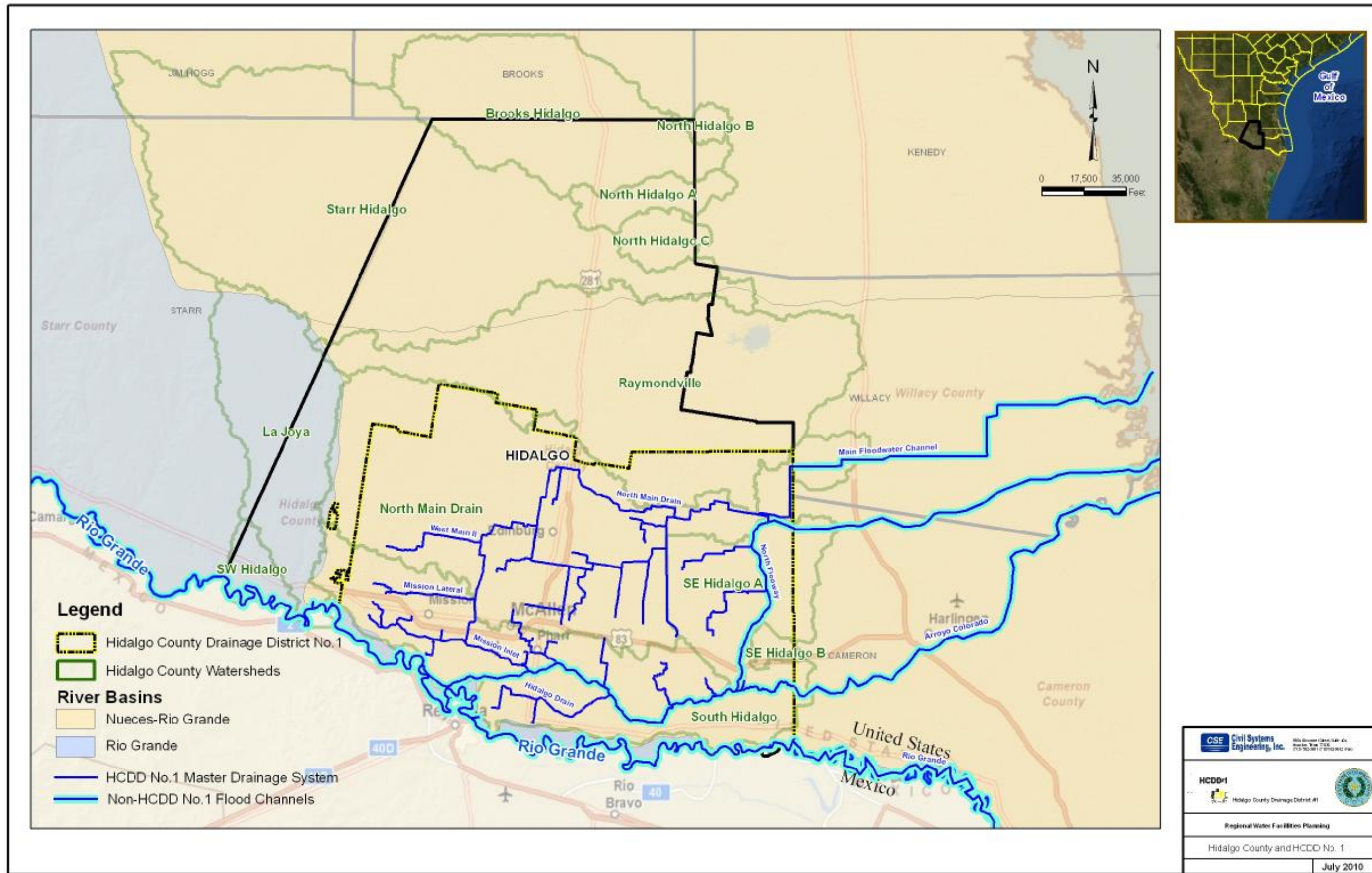

Figure 1-1. Hidalgo County and Hidalgo County Drainage District No.1

## 2 Water Rights

### Texas Water Rights Regulations

In Texas, surface water bodies are the property of the state but the right to use surface water for specific purposes such as irrigation or industrial is a private property right. Today these water rights are regulated by the Texas Commission on Environmental Quality (TCEQ) which is responsible for issuing and administering water rights in Texas. Groundwater is privately owned by the owner of the land above it and the owners may pump all the water they can from beneath their land regardless of the impact to nearby landowners unless the water is regulated.

According to the Texas Water Code, Section 11.021, water owned by the state includes water of ordinary flow, underflow, and tides of every flowing water, natural stream, and lake; and of every bay or arm of the Gulf of Mexico; and the storm water, floodwater, and rainwater of every river, natural stream, canyon, ravine, depression, and watershed in the State, and the water imported from any source outside the boundaries of the state for use in the state which is transported through the beds and banks of any navigable stream within the state or by utilizing any facilities owned or operated by the state.

In general, all users that divert or store water in Texas are required to possess a water right that authorizes, as necessary,



a specified amount of water that can be diverted from a particular stream or reservoir, the maximum rate of diversion, the maximum storage capacity of a reservoir, and in the case of irrigation, the location of the fields that are to be irrigated.

Texas law states that diffused surface water - stormwater runoff and sheet flow - is not state water. These waters do not flow in any defined water course, but rather cross the surface of the earth in variant and unregulated ways. Diffused surface water is subject to capture and use by the landowner. Once this water enters a stream, river, or other state water body, it becomes state water.

As discussed in Section 4.8.4 of 2011 Region M Regional Water Plan, captured stormwater could be made available for local use provided it has not been appropriated to any existing water rights. The 2011 Region M Regional Water Plan considers all stormwater flowing into the Rio Grande or the Arroyo Colorado as having been appropriated to existing water rights and unavailable for development.

## **Project Water Rights**

The proposed water development projects are located within the preliminary FEMA North Main Drain Watershed as delineated for the Hidalgo County Flood Map Modernization Project, with a total drainage area of 444 square miles. Depending on the locations of the proposed project sites, the percentage of watershed contributing storm runoff flows ranges from 59 percent (263 square miles) to 91 percent (403 square miles). As shown in **Figure 2-1**, there are no hydrologic connections between the HCDD No.1 drainage systems within the North Main Drain Watershed and the Rio Grande River or the Arroyo Colorado.

The proposed projects do not capture any stormwater contributing to flows into the Rio Grande and Arroyo Colorado. The proposed projects divert drainage water from the North Main Drain and Main Floodwater Channel which drain to Laguna Madre and subsequently into the Gulf of Mexico.

There are no existing water rights associated with the Rio Grande River and Arroyo Colorado to be affected by the proposed water development projects. The drainage water within the Hidalgo County Drainage District Master Drainage System is a potential water source and should be developed for future drinking water needs within Hidalgo County.

The water rights database of Texas Commission on Environmental Quality (TCEQ) has been reviewed and analyzed in the 2006 Hidalgo County Water Development Project report. All water

rights authorizing surface water diversions and use within Hidalgo County were identified. The total municipal water rights in the county at that time were 135,123 acre-ft per year with the total for all uses being 1,081,031 acre-ft per year.

## **Legal Investigation and Coordination**

For the purpose of the project, extensive research was made on the rights of Hidalgo County to utilize the water within the Hidalgo County Drainage District No.1 drainage systems. Texas Water Code and other water rights regulations related to this project were reviewed. Existing water rights data within the study area was obtained from TCEQ water rights GIS database and mapped. Coordination with TCEQ was made. At this time of the report, there is still a disagreement between TCEQ and Hidalgo County. Hidalgo County is of the opinion that the subject water is diffused water captured in a manmade drainage ditch system (not a natural water course) and Hidalgo County has the rights of developing the drainage water within the drainage system for beneficial uses. Hidalgo County believes a water rights permit will not be required to develop the drainage water and the drainage water belongs to the County.



### 3 Water Supply and Demand Analysis

#### HCDD No.1 and Hidalgo County Master Drainage Systems

In accordance with Article 16, Section 59 of the State Constitution of Texas, Hidalgo County Drainage District No.1 is charged with responsibility to provide management for conservation and development of natural resources of the State including storage, preservation, and distribution of its stormwaters. Outfall drainage in Hidalgo County is provided by a network of large drainage ditches that were constructed during the late 1970s through the middle 1980s. These drainage ditches are collectively referred as the Hidalgo County Master Drainage System (HCMDS). Outfall drainage ditches generally related to the Mission Ridge and the natural levee system which extends along the north bank of the Rio Grande from a point southwest of Mission to the mouth of the river at the Gulf of Mexico. Mission Ridge is a minor rise whose crest forms a drainage divide extending generally along U.S. Highway 83 from a short distance west of Mission to a point about midway between Weslaco and Mercedes. The ditches south of U.S. 83 outfall into the IBWC Main Floodway which then splits into the Arroyo Colorado and North Floodway, which carries flows into the Laguna Madre. The ditches in the northern portion of U.S. 83 outfall into either the HCMDS Main Floodwater channel or IBWC



North Floodway, which carries flow through Willacy County to the Laguna Madre.

The HCMDS was initiated in the summer of 1981 by constructing the Main Floodwater channel which outfalls into the Laguna Madre extending 36 miles from Panchita. Other constructed drainage channels include: South Main Drain, North Main Drain, East Lateral Drain, Southwest Lateral, Pharr-McAllen Lateral, Mission Lateral, Edinburg Lateral, Mission Inlet and Rado Drain, Weslaco Drain, West Mercedes Drain, and East Donna Drain. The HCMDS has been expanded in recent years by the construction of South Floodwater Channel, Hidalgo Drain, South Pharr Drain, West Main Drain, Edcouch-Elsa Lateral, and others. The District is responsible for the continued development and maintenance of the HCMDS.

These drainage outfall ditches collect and convey runoff from various storm events. Also, many sections of the drainage ditches provide linear detention to attenuate flood peak discharges.

HCMDS has a depth varying from 12 to 15 feet. Since the shallow groundwater

within the district limit has an average depth of 10 feet, HCMDS drainage ditches have year-round shallow groundwater discharges.

**Figure 3-1** shows the Hidalgo County Master Drainage System network.

## Water Supply

Availability of existing water supplies in Hidalgo County and in the Lower Rio Grande Basin as a whole were analyzed in several studies including the 2011 Region M Regional Water Plan and the 2006 Hidalgo County Water Development Project. Practically all of the dependable surface water supply that is available to Hidalgo County is from the yield of the Amistad and Falcon International Reservoirs on the Rio Grande River. These reservoirs are operated as a system by the International Boundary and Water Commission (IBWC) for flood control and water supply purposes. Groundwater from the Gulf Coast Aquifer is used to supplement surface water sources under severe drought conditions.

The dependable firm water supply available from the Amistad/Falcon Reservoir System during drought-of-record conditions is projected to decrease significantly as a consequence of reduced conservation storage capacity due to sedimentation of the reservoir system. It was projected that the firm yield of the Amistad/Falcon Reservoir System will decrease by nearly 115,000 acre-feet or by nearly 10 percent by 2060.

Also the dependable yield of the reservoir system is projected to reduce due to the failure of Mexico to maintain

its minimum inflow requirement to the Rio Grande as stipulated in a 1944 treaty between Mexico and the United States. Based on records published annually by the IBWC, there was a deficit of inflows of 1,024,000 acre-feet allotted to the United States from the Mexico tributaries during the five-year accounting cycle ending October 2, 1997.

The Arroyo Colorado is located in the Nueces-Rio Grande River Basin. It drains eastward into the Gulf of Mexico via the Laguna Madre. It is partly used as a navigational body for commercial shipping to the Port of Harlingen and its flows are critical to sustaining the ecology of the Laguna Madre. The Arroyo Colorado as a water supply source for domestic, municipal, and industrial uses has been limited due to economic, environmental, and water quality issues.

Groundwater has been used as a secondary source of water supply in the county. The Gulf Coast Aquifer is the main source of groundwater in Hidalgo County.

Based on the 2011 Region M Regional Water Plan, total water supply of Hidalgo County is projected to decrease from approximately 548,932 acre-feet per year in 2010 to approximately 533,826 acre-feet per year in 2060. Municipal water is expected to increase slightly during the 50-year period from 144,029 to 145,215 acre-feet per year.

## Water Demand

According to the 2011 Region M Regional Water Plan, Hidalgo County's population is expected to increase by more than 164 percent between 2010 and 2060 to approximately 2,048,911.

The combined demand for municipal, manufacturing, steam electricity, mining, and livestock water uses in the county is expected to increase by 139 percent from 131,124 acre-feet in 2010 to 313,577 acre-feet in 2060. Due to urbanization, irrigation demand is expected to reduce by 22 percent from 583,030 acre-feet in 2010 to 453,772 acre-feet in 2060. During the same period, municipal water demand is expected to increase by 142 percent from 115,410 acre-feet to 278,964 acre-feet. The projected 2060 water demand for all uses is 767,349 acre-feet.

## Water Needs

Water needs (shortage of water) were determined in the 2011 Region M Regional Water Plan by comparing the projected water demands with projected water supplies. The comparison was made with consideration of each water user group. Projected municipal water shortages for Hidalgo County for each water user group and decade of the planning period (2010 - 2060) are summarized in **Table 3-1**. As shown in the table, the City of McAllen will face a water supply shortage of approximately 29,457 acre-feet in 2060. The City of Mission will have a water shortage of approximately 19,674 acre-feet in 2060. For the same planning year, The City of Pharr, the City of Edinburg, and the City of San Juan will all face water shortages. The sum of all municipal deficit

projections for the county in the year 2060 is approximately 139,930 acre-feet. Hidalgo County is anticipated to face significant water supply shortages in the future.

## Development Opportunity

To address the projected future water shortages facing the county, significant study efforts have been made. A range of water management strategies were identified, evaluated, and recommended in the 2011 Region M Regional Water Plan. The following is a list of the recommended alternative strategies:

1. Water conservation.
2. Reuse of wastewater flow.
3. Acquire additional Rio Grande water through water right purchase and contract.
4. Purchase additional Rio Grande water through irrigation water rights conversion.
5. On-farm conservation with conveyance improvement.
6. Conveyance efficiency improvement.

As discussed in the 2011 Region M Regional Water Plan, the utilization of the existing HCMDS facilities (large manmade drainage channels and detention basins) and additional new facilities to capture, convey, and treat constantly flowing water within the drainage system of Hidalgo County Drainage District No.1, as an optional drinking water source was not recommended as an alternative water management strategy due to lack of technical information at the time. For any funding to be available from the TWDB, the proposed project will need to be added as a viable water

management strategy in the 2011 Region M Regional Water Plan or will require support from the Region M Regional Water Planning Group for a consistency waiver.

The use of the existing drainage facilities for both drainage/flood control and water supply will be more cost effective without a proportional increase in costs and thus enhance the economic justification for the project. Additional storage and diversion facilities will provide flood control benefits in conjunction with water supply. Based on the 2006 Hidalgo County Water Development Project, there is a dependable base flow rate of 58.5 cfs in the Main Floodwater Channel, which translates to 42,300 acre-feet per year. **Figure 3--2** shows the field measurement locations performed for the 2006 Hidalgo County Water Development Project.

With consideration of potential rainfall runoff from the contributing drainage basin, the available water to be developed could be significantly increased. Conservatively estimated, there is an approximate annual runoff of 160 acre-feet per square mile per year within the study area. **Figure 3-3** shows the existing gauge locations located within the study area.

### **Current Water Supply Network and Service Areas**

A study entitled “The Municipal Water Supply Network of The Lower Rio Grande Valley” was conducted in 2004 by the Irrigation District Team (IDEA) of the Irrigation Technology Center of the Texas Water Resources Institute at Texas A&M University. The study

report showed that the existing municipal water supply network in the region consists mainly of lined and unlined canals, pipelines, resacas, and reservoirs that belong to irrigation districts but also carry water for municipal uses.

There are several municipal water providers in the area to provide treated water to end users. Each water utility has its service area delineated by its Certificate of Convenience and Necessity (CCN) as regulated by the Texas Commission on Environmental Quality (TCEQ). The CCN service areas from the TCEQ Water Utility Database (WUD) for Texas Water Districts and Public Drinking Water Systems are shown in **Figure 3-4**.

Three alternative project locations were selected. Two locations are along the North Main Drain and one location is further downstream at the transition to the Main Floodwater Channel. Although all three proposed locations are within the CCN service area boundaries of the North Alamo WSC, potential service areas also include the Cities of Alamo, Edcouch, Edinburg, Hidalgo, La Joya, McAllen, Mission, Pharr, San Juan, Sharyland WSC, Weslaco, and other Hidalgo County areas which have a combined projected near-term water deficit of 38,126 acre-feet in year 2030. These cities and surrounding non-incorporated areas can potentially be served from any of these three locations via the North Alamo WSC or any of the other water utility districts. As shown in **Table 3-1**, the North Alamo WSC service to Hidalgo County is also projected to experience water shortages of up to 2,345 acre-feet in 2040.



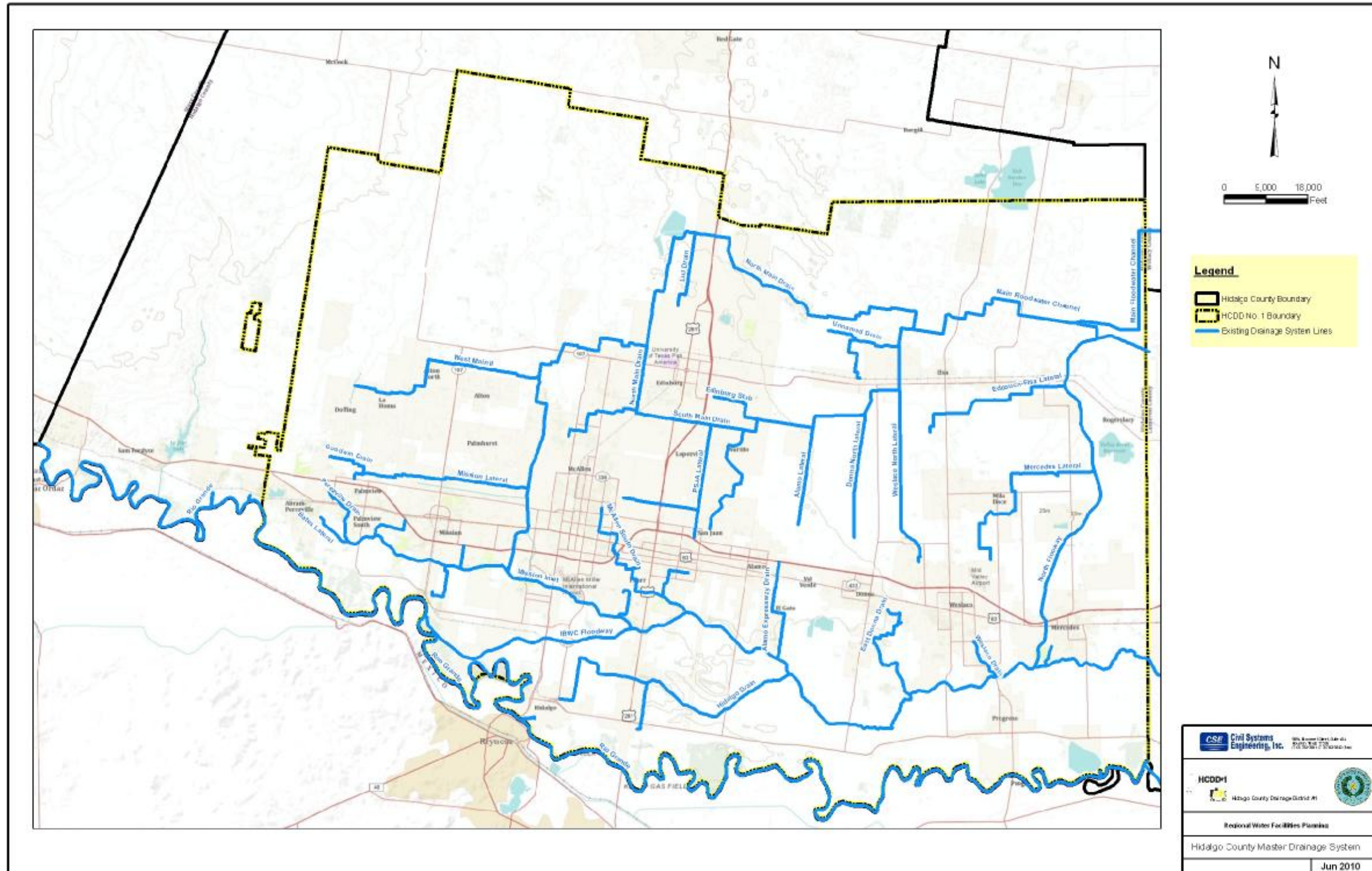

Figure 3-1. Hidalgo County Master Drainage Systems

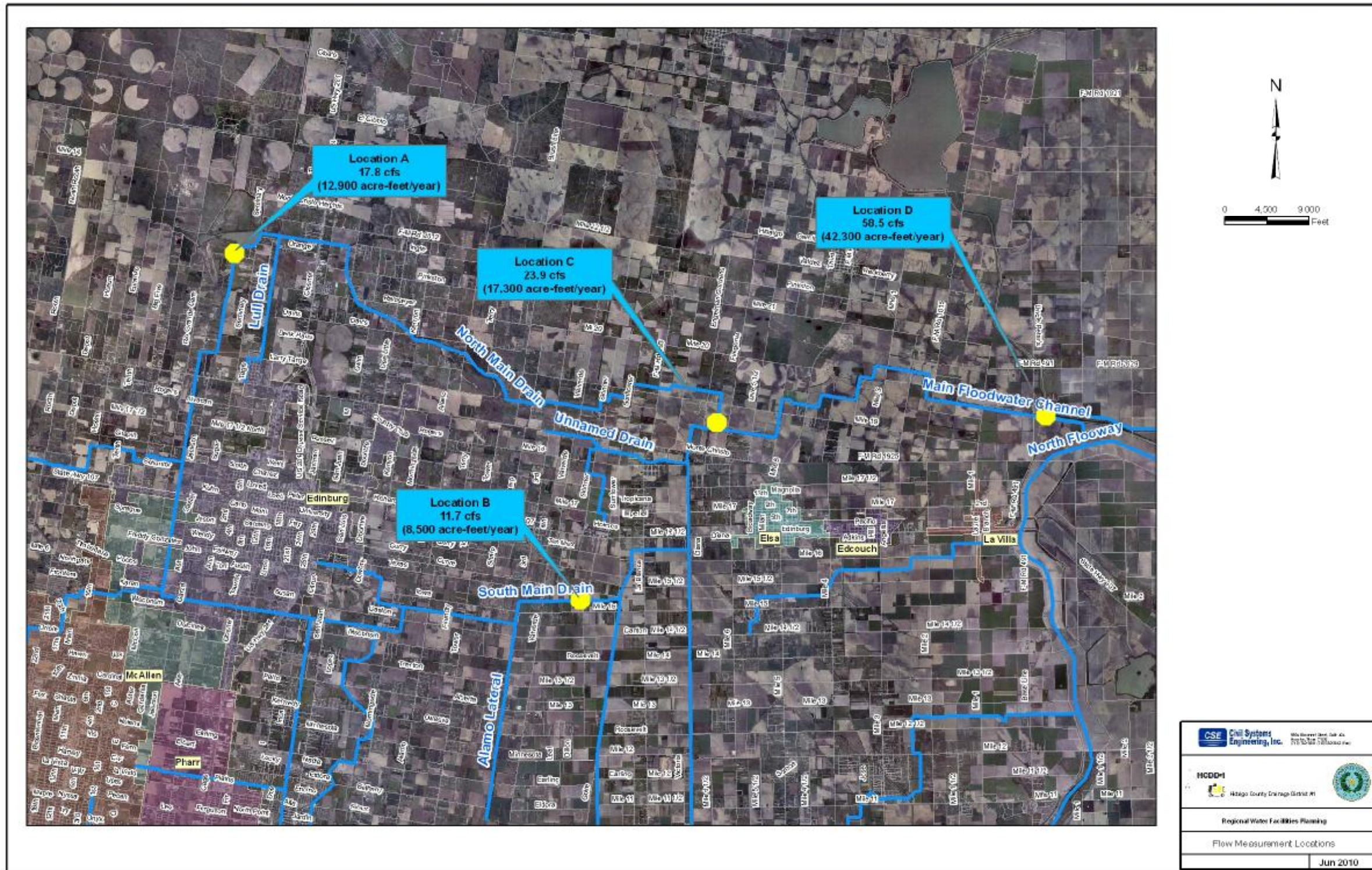

Figure 3-2. Base Flow Measurement Locations

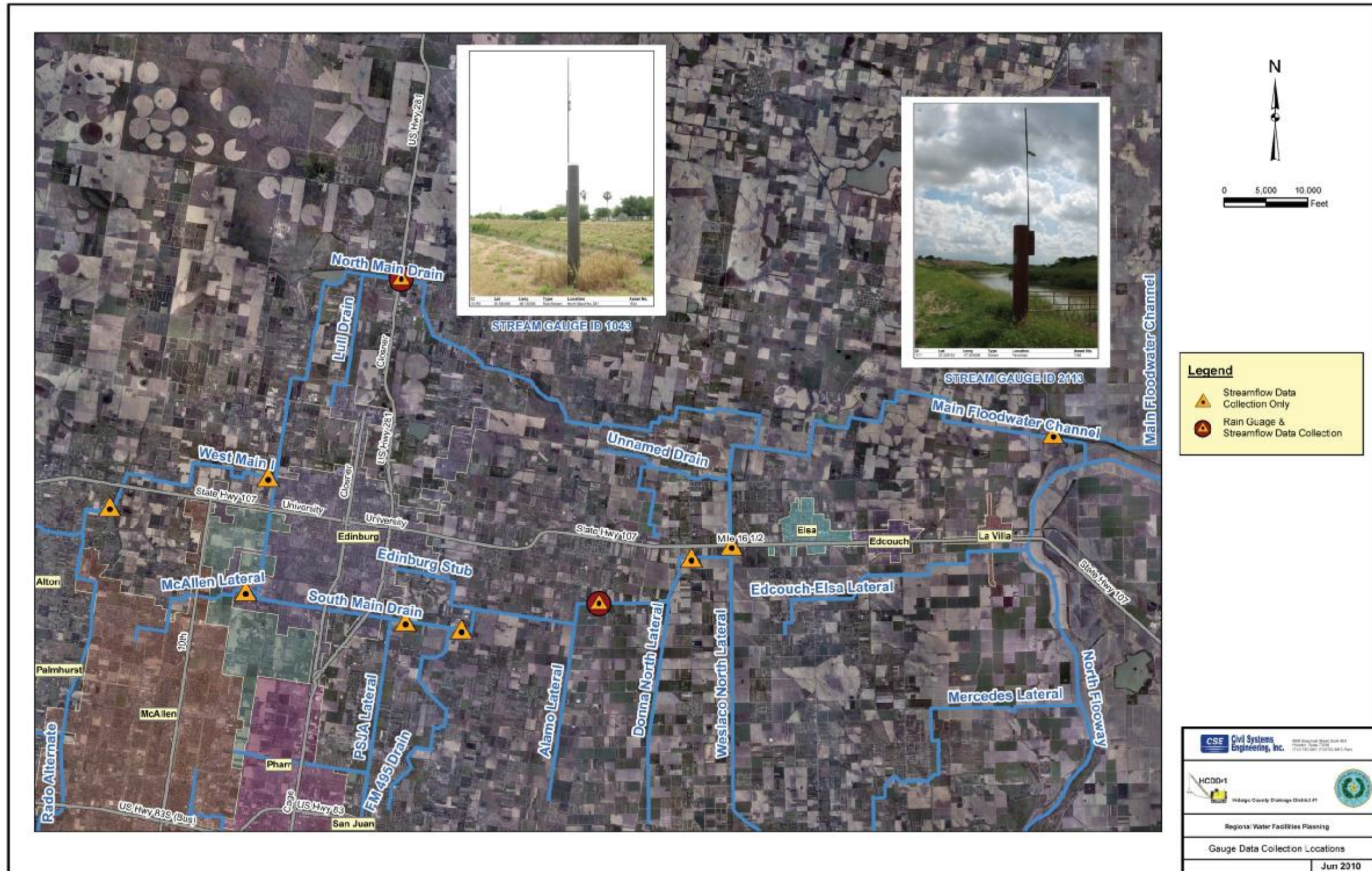

Figure 3-3. Stream Gauge Stations

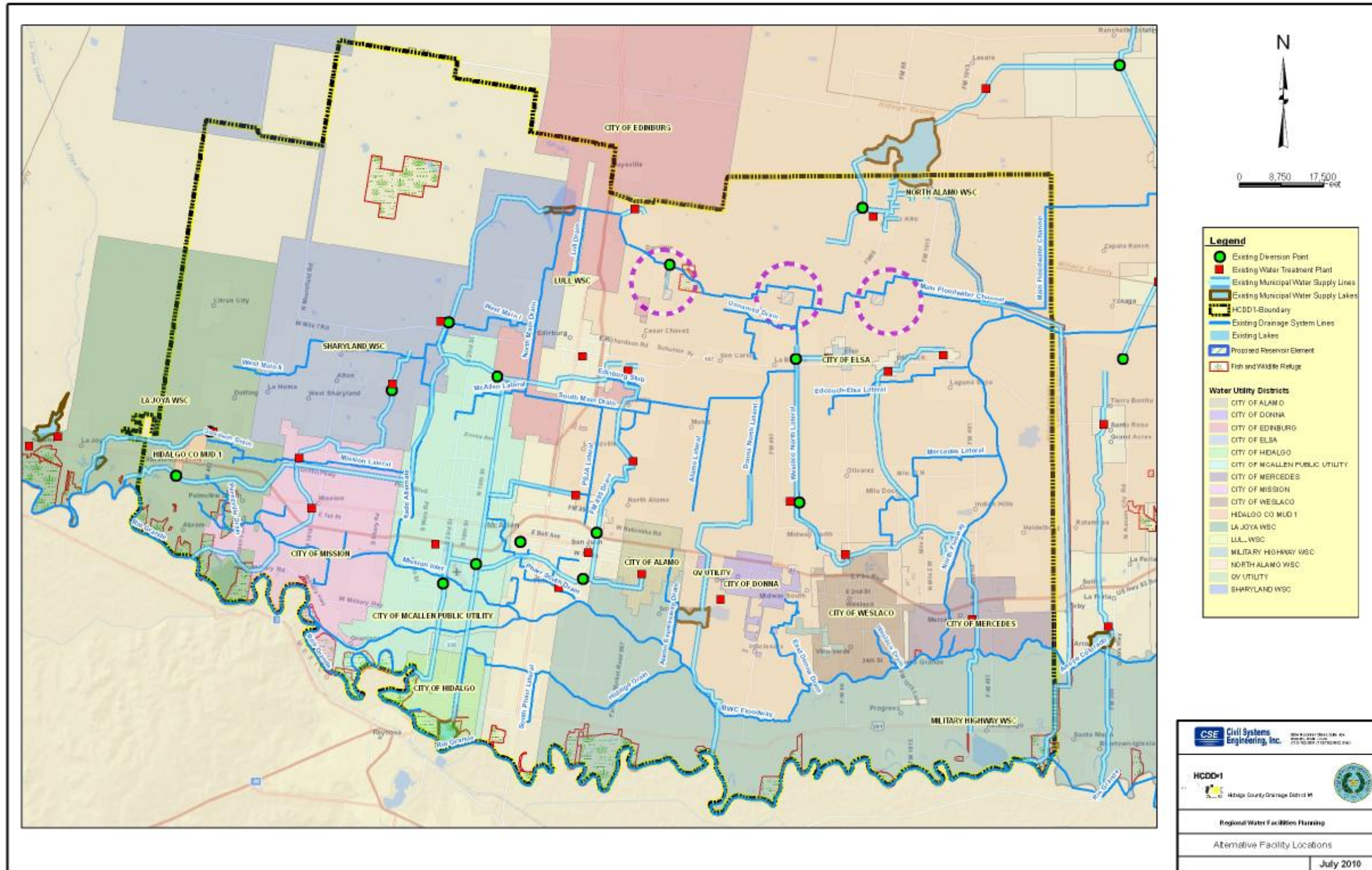

Figure 3-4. Current Water Supply Network and Service Areas

**Table 3-1. Hidalgo County Projected Municipal Water Surplus and Needs (AF)**

Water User Group	River Basin	Surplus/Deficit (ac-ft/yr)					
		2010	2020	2030	2040	2050	2060
Alamo	Nueces-Rio Grande	-59	-762	-1,548	-2,415	-3,407	-4,424
Alton	Nueces-Rio Grande	0	0	-2,446	-3,419	-4,482	-5,602
Donna	Nueces-Rio Grande	1,729	1,435	1,117	759	347	-103
Edcouch	Nueces-Rio Grande	-129	-188	-255	-332	-420	-516
Edinburg	Nueces-Rio Grande	6,216	3,826	1029	-1,805	-5,151	-8,580
Elsa	Nueces-Rio Grande	659	603	534	460	364	258
Hidalgo	Nueces-Rio Grande	594	209	-219	-685	-1,206	-1,740
Hidalgo	Rio Grande	-2	-18	-20	-27	-49	-71
Hidalgo City MUD	Nueces-Rio Grande	-1,130	-1,814	-2,588	-3,421	-4,342	-5,287
La Joya	Nueces-Rio Grande	46	-5	-59	-120	-189	-265
La Joya	Rio Grande	19	-2	-25	-51	-80	-113
La Villa	Nueces-Rio Grande	256	258	259	261	261	258
McAllen	Nueces-Rio Grande	2,627	-2,501	-8,474	-14,830	-21,932	-29,453
McAllen	Rio Grande	0	-1	-1	-2	-3	-4
Mercedes	Nueces-Rio Grande	3,231	3,123	2,988	2,846	2,652	2,434
Military Hwy WSC	Nueces-Rio Grande	-8	-143	-422	-780	-1120	-1479
Military Hwy WSC	Rio Grande	0	0	0	0	-4	-9
Mission	Nueces-Rio Grande	-1,470	-4,468	-7,824	-11,365	-15,469	-19,674
North Alamo WSC	Nueces-Rio Grande	8,983	5,627	1,853	-2,345	-7,180	-12,150
Palmhurst	Nueces-Rio Grande	0	0	209	-296	-929	-1,633
Palmview	Nueces-Rio Grande	0	0	0	0	-447	-906
Pen itas	Nueces-Rio Grande	5	3	2	-1	-7	-16
Pharr	Nueces-Rio Grande	376	-1,754	-4,152	-6,799	-9,649	-12,695
Progreso	Nueces-Rio Grande	0	0	0	0	0	0
San Juan	Nueces-Rio Grande	-478	-1,642	-2,933	-4,361	-6,008	-7,697
Sharyland WSC	Nueces-Rio Grande	1,624	-391	-397	-1,331	-2,296	-3,335
Sullivan City	Rio Grande	159	186	184	13	-197	-411
Weslaco	Nueces-Rio Grande	1,043	286	-579	-1537	-2,622	-3,787
County-Other	Nueces-Rio Grande	1,028	-2,179	-5,775	-9,722	-14,197	-18,779
County-Other	Rio Grande	60	-187	-409	-652	-927	-1,210
<b>SUM OF DEFICITS</b>		<b>-3,276</b>	<b>-16,055</b>	<b>-38,126</b>	<b>-66,296</b>	<b>-102,313</b>	<b>-139,930</b>
<b>SUM OF EXCESS SUPPLIES</b>		<b>28,655</b>	<b>15,556</b>	<b>8,175</b>	<b>4,339</b>	<b>3,624</b>	<b>2,950</b>

## 4 Siting Analysis

This section presents the potential intake and water treatment plant sites (Project Sites) identified and evaluated for the project. The purpose of siting analysis is to assess feasibility and suitability of the proposed project sites. The following considerations were given in identifying and evaluating the potential project sites:

- § Dependable water source
- § Proximity to source water and service areas
- § Site topography and accessibility
- § Land use/land cover
- § Environmental
- § Floodplain

Three (3) alternative project sites (SITE I, II, and III) were first identified based on available information on aerial photography, water availability, floodplain maps, topographic data, land use/land cover, oil and gas pipeline map, roadway map, and local knowledge of the study area. The three potential project sites are named as SITE I, SITE II, and SITE III, as shown in **Figure 4-1**. SITE I and II are located on the North Main Drain, and SITE III is located on the Main Floodwater Channel. Following the desktop analysis, a baseline environmental investigation was performed for each site.

To assist the project development, ArcGIS 9.3 was used consistently throughout the entire project for analysis and presentation. Digital data were obtained from various sources for this siting analysis. Recent aerial photography was obtained from the Hidalgo County Drainage District No.1

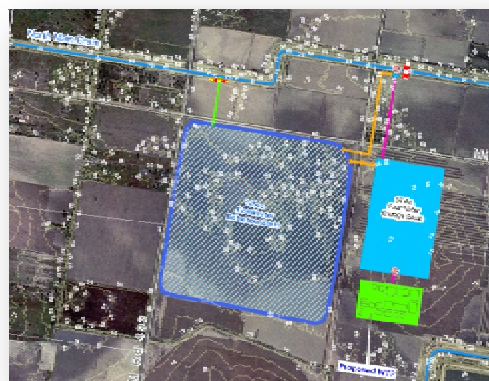

and was used as the primary base map data. The aerial photo map has a ground resolution of 1.5 feet, which provides the necessary information on land use and land cover for the study area. LiDAR DEM dataset (15-foot resolution) developed for the Hidalgo County Flood Map Modernization Project was obtained, which provided the precision topographic data needed for the siting analysis. FEMA effective floodplain map data was obtained from FEMA and Hidalgo County Drainage District No.1. Roadway map, land use/land cover map, and soil map were downloaded from the Texas Natural Resources Information System (TNRIS) website. Oil and gas pipeline data was also obtained Texas Railroad Commission.

**Figure 4-2** illustrates the FEMA effective 100-year floodplain and the proposed project sites.

### Water Availability

Based on the 2006 Hidalgo County Water Development Project, historical observations, and local knowledge, the North Main Drain and Main Floodwater Channel have constantly flowing drainage water. During the 2006 study, flow measurements were made at four

(4) locations within the HCDD No.1 Mater Drainage System to determine base flow conditions within the drainage network, as shown in **Figure 3-2**. The measured base flow rates along the North Main Drain and Main Floodwater Channel are 17.3, 23.9, and 53.8 cfs, respectively at location A, C, and D from upstream to downstream. These flow rates translate to 12,900, 17,300, and 42,300 acre-feet/year, respectively at each location.

To further demonstrate the availability of drainage water within the North Main Drain and the Main Floodwater Channel. Stream gauge data was obtained from Hidalgo County Drainage District No.1. There is one stream gage station on the North Main Drain at US 281 (ID 1043) and one on the Main Floodwater Channel at Panchitas (ID 2113), as shown in **Figure 3-3**. A plot of water surface elevations at the Panchitas stream gage station for the period of September 29, 2008 to September 30, 2009 is shown in **Figure 4-3**. As illustrated, there is water constantly flowing within the Main Floodwater Channel. The average water depth at Panchitas stream gauge station location was 4 feet varying from 1.5 feet to 18.5 feet during the water year.

To quantify the storm water runoff within the drainage system (specifically along the North Main Drain and the Main Floodwater Channel), which can be potentially captured for water supply, the HEC-HMS hydrologic model developed for the Hidalgo County Flood Map Modernization Project was obtained to estimate runoff at the potential project sites. **Figure 4-4** shows the resulting runoff variations within the North Main Drain at Brush Line Road

for the driest year of 1950 on record. As shown, even for the driest year on record, there were still significant runoff flows within the North Main Drain drainage ditch. During a storm event, rainfall runoff or floodwater can be diverted to a storage basin (floodwater detention basin) which can later be used to supplement the base flow to augment the available water supply and reliability. The floodwater detention basin also provides flood control benefit by reducing flood risk along the drainage channel.

## **Components of Raw Water Conveyance System**

Same components for water diversion, conveyance, storage, treatment and operation strategy were proposed at all potential project sites. The facility components include:

- § Diversion weir structure on the drainage channel to regulate water level with the drainage ditch
- § Inlet structure with screens to withdraw base flow water to the raw water storage basin
- § Wet well for the diversion transfer pump station
- § Diversion transfer pump station to pump drainage ditch water to the raw water storage basin
- § Force main I from the diversion transfer pump station to the raw water storage basin
- § Raw water storage basin to regulate and provide water to the water treatment plant
- § Floodwater side weir structure to divert floodwater to the floodwater detention basin
- § Diversion channel to convey floodwater from the side weir

structure to floodwater detention basin

- § Conveyance channel I to convey floodwater within the floodwater storage basin to the raw water storage basin by gravity when water level in the floodwater detention basin is higher than the raw water storage basin for water supply to the water treatment plant.
- § Conveyance channel II to convey floodwater within the detention basin to the wet well and to be pumped to the raw water storage base for water supply to the water treatment plant.
- § Water treatment plant intake pump station to supply water to the water treatment plant.
- § Force main II from raw water storage basin to water treatment plant

**SITE I**

**Figure 4-5** shows the diversion and water treatment plant location of SITE I. The proposed diversion is located on the North Main Drain approximately 2,700 feet east of Kenyon Road. The raw water storage basin, floodwater detention basin, and water treatment plant as a whole are located north of Monte Cristo Road west of Alamo Road.

All components except the diversion structures are located outside the FEMA effective 100-year floodplain, except the diversion intake structures, as illustrated in **Figure 4-2**.

The topography at this site is very flat with an elevation (NAVD 88) varying from 78 to 82 feet from the diversion to the water treatment plant. Due to the flat topography nature, pumping is required to transfer water from the drainage ditch to the raw water storage basin. Pumping

is also required from the raw water storage basin to the water treatment plant.

There is a total contributing drainage area of 263 square miles to this location. Based on the flow measurements performed for the 2006 Hidalgo County Water Development Project, the approximate base flow is 17.3 cfs at this diversion location.

A Baseline Environmental Study was performed for each project site with the following environmental considerations:

- § Land Use and Socioeconomic Issues
- § Coastal Zone Management Act
- § Farmland Protection Policy
- § Floodplains
- § Air and Water Quality Issues
- § Wild and Scenic Rivers Act
- § Natural Resources Issues
- § Endangered Species
- § Archeological and Historical Resources
- § Hazardous Material Issues
- § Environmental Justice

As concluded in the baseline environmental study in **Appendix A** (attached CD-ROM), there are no major environmental concerns at project SITE I.

This project site is relative proximity to the major Cities of Edinburg, McAllen, Mission, and Pharr. It is located very close to Monte Cristo Road, a major east-west thoroughfare in Hidalgo County. There are other alternative roads to access to the site. The proposed floodwater detention basin has a higher flood control benefit since it is located relatively upstream of the channel.



The water treatment plant capacity is limited to approximately 10 MGD with consideration of the availability of dependable base flows at the location.

## SITE II

**Figure 4-5** shows the diversion and water treatment plant location of SITE II. The proposed diversion is located on the North Main Drain approximately 2,500 feet east of FM Rd 493. The raw water storage basin, floodwater detention basin, and water treatment plant as a whole are located just south of Mile 19 between FM Rd 493 and Engerman Gardens Road.

The proposed water treatment plant is located outside of the FEMA effective 100-year floodplain. Portion of the proposed raw water storage basin is located in the 100-year floodplain and the entire floodwater detention basin is located within the 100-year floodplain. The potential impact of the raw water storage basin on floodplain storage will be mitigated by the construction of the floodwater detention basin.

Like SITE I, the topography at this site is very flat with an elevation (NAVD 88) varying from 66 to 68 feet from the diversion to the water treatment plant. Pumping is required to transfer water from the drainage ditch to the raw water storage basin. Pumping is also required from the raw water storage basin to the water treatment plant.

There is a total contributing drainage area of 290 square miles to this location. Based on the flow measurements performed for the 2006 Hidalgo County Water Development Project, the approximate base flow is 23.9 cfs at this

diversion location. There is a contributing drainage area of 283 square miles to this location.

As concluded in the baseline environmental study in **Appendix A** (attached CD-ROM), there are no major environmental concerns at project SITE II.

This project site is also relative proximity to the major Cities of Edinburg, McAllen, Mission, and Pharr, compared with SITE III, and small Cities of Elsa, Edcouch, and La Villa. It is located approximately 3,000 feet north of Monte Cristo Road. There are other alternative roads to access to the site. .

The water treatment plant capacity at this location is limited to approximately 15 MGD with consideration of the availability of dependable base flows.

## SITE III

**Figure 4-6** shows the diversion and water treatment plant location of SITE III. The proposed diversion is located on the Main Floodwater Channel, 6,200 feet downstream of FM Rd 88. The raw water storage basin, floodwater detention basin, and water treatment plant as a whole are located just south of Mile 19 between FM Rd 88 and Mile 3.

All components except the diversion structures are located outside FEMA effective 100-year floodplain, except the diversion intake structures.

Like SITE I and II, the topography at this site is very flat with an elevation (NAVD 88) varying from 62 to 72 feet from the diversion to the water treatment plant. Pumping is required to transfer

water from the drainage ditch to the raw water storage basin. Pumping is also required from the raw water storage basin to the water treatment plant.

favorable site. However, the final selection will also depend on the potential service areas, land values, and legal and political considerations.

There is a total contributing drainage area of 403 square miles to this location. As discussed earlier, there is an approximate base flow of 58.5 cfs at this diversion location.

As concluded in the baseline environmental study in **Appendix A** (attached CD-ROM), there are no major environmental concerns at project SITE III.

This project site is proximity to Cities of Elsa, Edcouch, and La Villa. It is located approximately 5,000 feet north of Monte Cristo Road. There are other alternative roads to access to the site.

There is a more reliable water source at this site. The potential capacity of the proposed treatment plant can be much larger than the 15 MGD with consideration of the availability of dependable base flows at the location.

There is an approximate distance of 9 miles between SITE I and SITE III. The elevation difference between these two sites is approximate of 16 feet. The overland slope is very flat, approximately 1.7 feet per mile.

Comparing the three potential project sites, SITE III has the most reliable water supply of the three sites. To provide treated water to the cities such as Edinburg, McAllen, Pharr, and Mission, longer transmission lines are required. With consideration of the primary purpose of this project for water supply, SITE III is probably the most

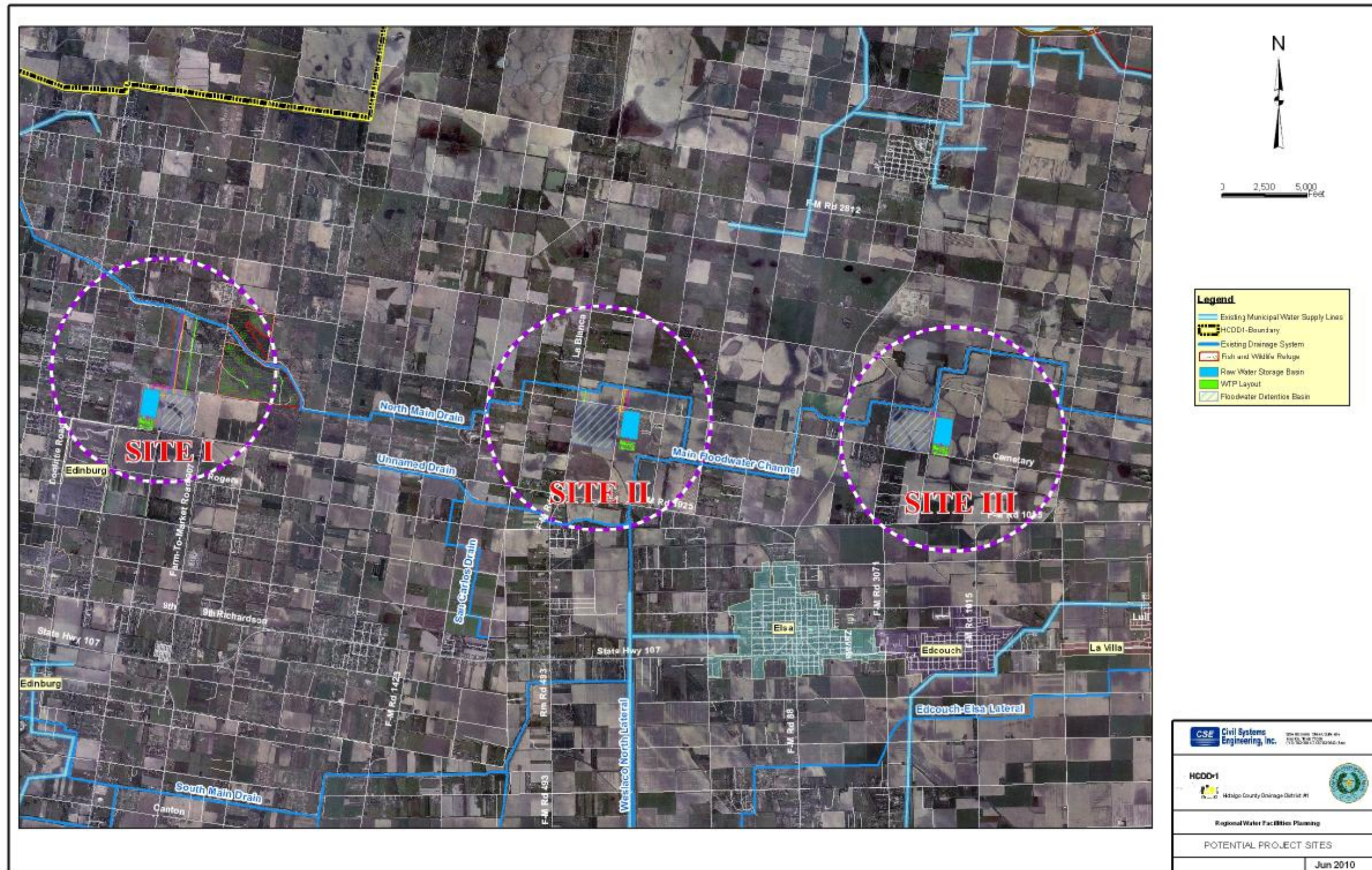

Figure 4-1. Potential Project Sites



Figure 4-2. FEMA Effective 100-Year Floodplain Map

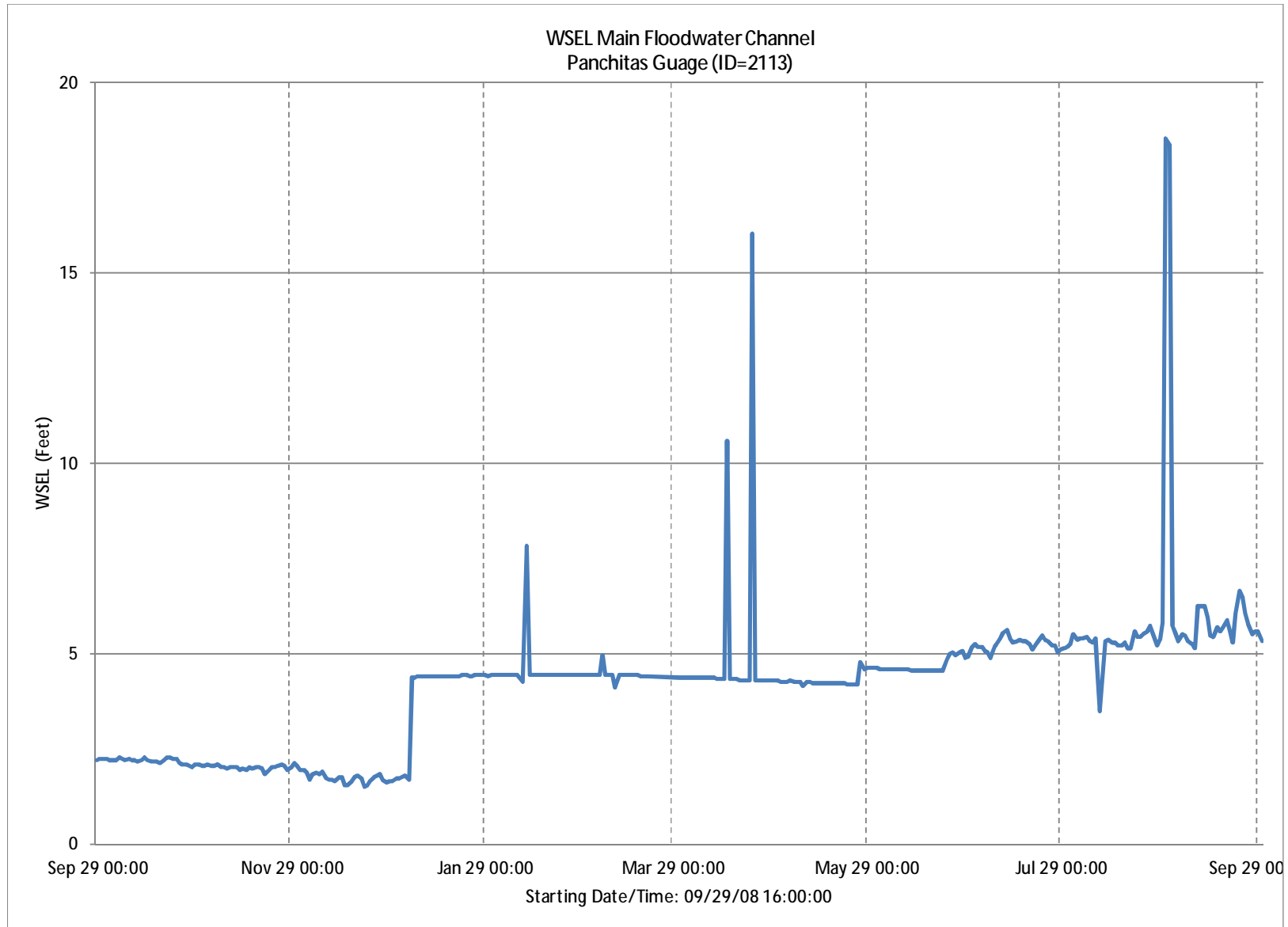

Figure 4-3. Stream Gauge Data (Sep. 29, 2008 – Sep. 30, 2009)

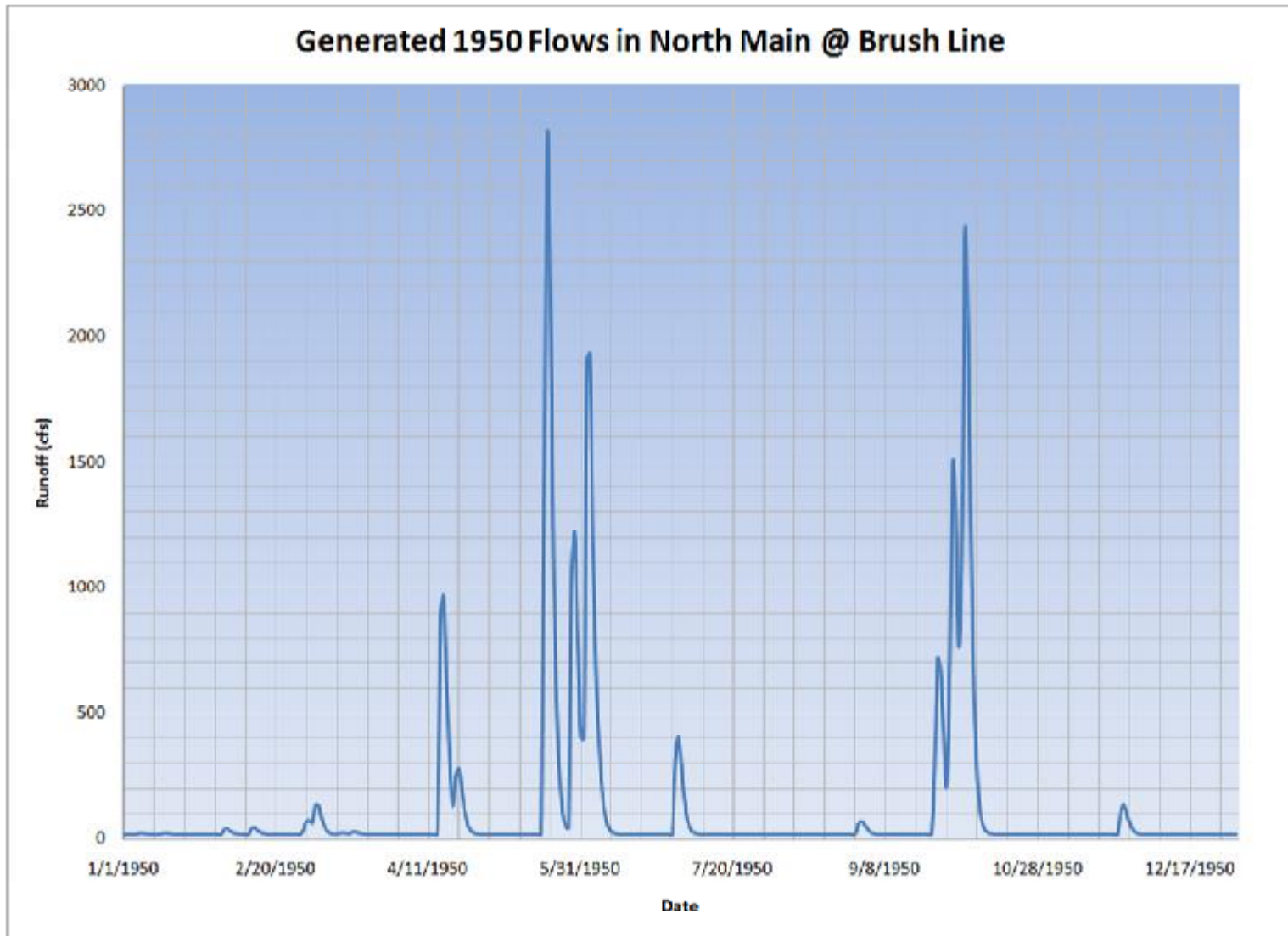

Figure 4-4. Synthetic Hydrograph (Combined Shallow Ground Water and Rainfall Runoff)



Figure 4-5. SITE I Facilities Plan Layout

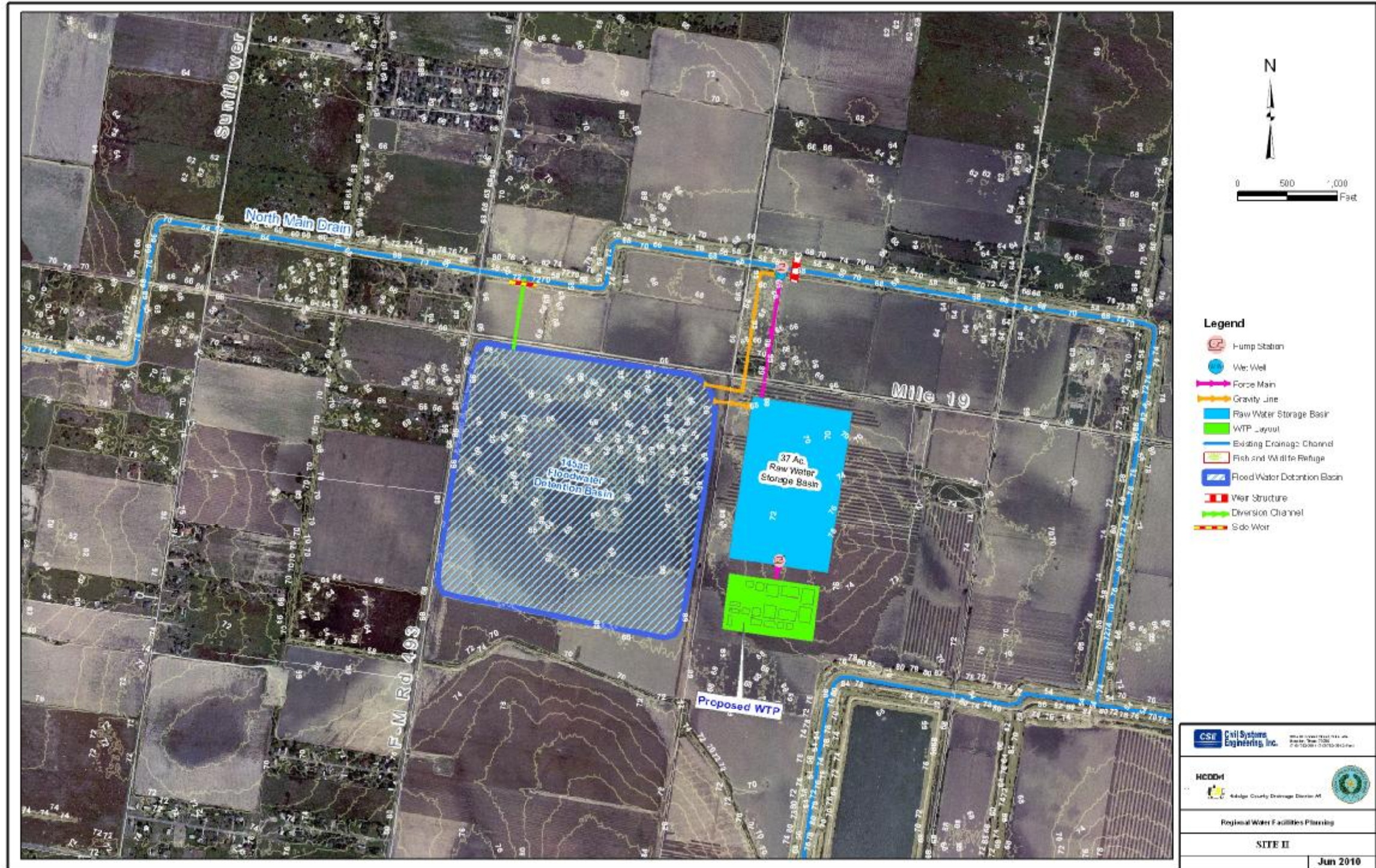

Figure 4-6. SITE II Facilities Plan Layout



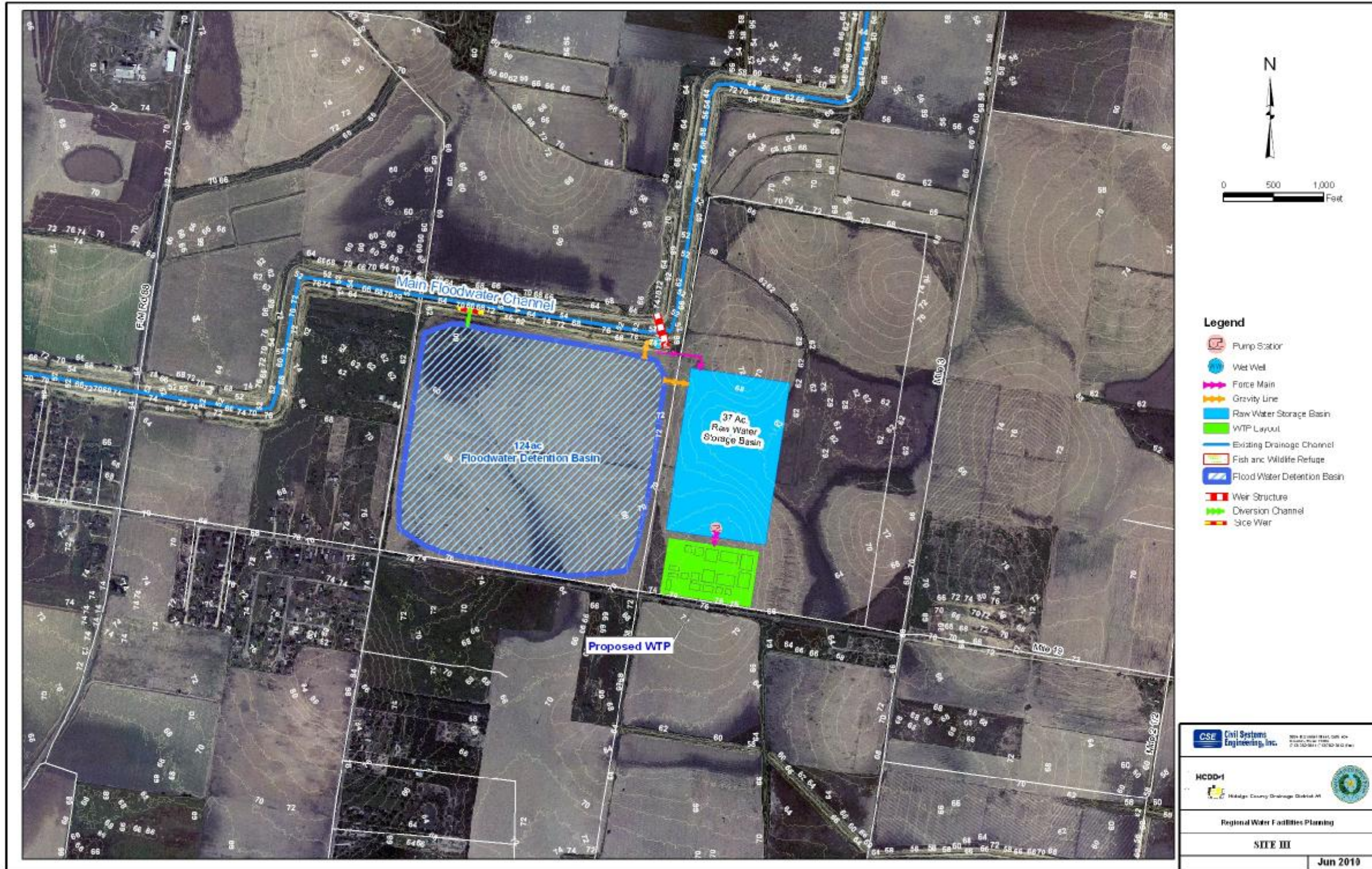

Figure 4-7. SITE III Facilities Plan Layout

## 5 Raw Water Conveyance Systems

The proposed raw water conveyance system at each diversion location is a combination of a weir structure on the ditch, intake inlet structure, intake pipes, a wet well, pump stations, raw water storage basin (RWSB), a side weir structure, and floodwater detention basin (FWDB).

### Weir Structure

A weir structure on the drainage ditch was proposed just downstream of each potential diversion point. The weir structure regulates the water level within the ditch to provide a more steady condition for raw water diversion under normal operating conditions.

### Intake Inlet

An intake inlet structure with screens was proposed to divert raw water by gravity via a intake pipe with diameter of 36 inches to a concrete vault (wet well). The diverted water first flows through the intake screens that remove large objects such as plants and logs. The proposed inlet structure has a capacity of 15 MGD.

### Wet Well

A concrete vault (wet well) was proposed for a intake pump station to lift the raw water to a raw water storage basin. The wet well has 35 feet in diameter and 25 feet in depth.



### Pump Stations

Two pump stations were proposed. The first pump station lift the raw water from the proposed wet well to the proposed RWSB. The second pump station deliver the raw water within the RWSB to the proposed water treatment plant (WTP).

The first pump station (Pump Station I) consists of two pumps (1 duty and 1 standby). Each has a capacity of 15 mgd.

The second pump station (Pump Station II) consists of four (3 duty and 1 standby). Each pump has a flow capacity of 5.5 mgd. Two of the pumps should be operated with variable drives (VFD). The proposed discharge pipe has a diameter of 36 inches.

### Raw Water Storage Basin

At project site, a RWDB was proposed to store raw water (diverted base flows) from the drainage ditch under normal operation conditions. The basin was sized with a 7-day storage at 15 MGD, which equates to approximately 244 acre-feet of volume. The RWSB will

provide protection and reliability against interruption in the raw water supply to the WTP which could result from planned or unplanned outages of the raw water diversion and conveyance facilities; reduce fluctuations in the raw water quality entering the WTP caused by rapid changes in raw water turbidity that can occur during rainfall events, and provide flow equalization.

### **Floodwater Detention Basin**

As part of the overall project, a FWDB was proposed at each location to store floodwater. Floodwater within the FWDB can be used to supplement the base flow water for water supply purpose during drought season. Also, the FWDB provides flood protection downstream along the ditch by reducing flood water flow rates.

At SITE I, the proposed FWDB has a total capacity of 616 acre-feet with a surface area of 88 acres. A diversion channel of 4,800 feet was proposed to convey floodwater to the basin. .

At SITE II, an FWDB of 797 acre-feet was proposed with a surface area of 145 acres. A diversion channel of 200 feet was proposed to convey floodwater to the basin by gravity. The function and operation of the proposed at this site are the same as the SITE I.

At SITE III, a FWDB of 625 acre-feet with a surface area of 124 acres was proposed. The function and operation of the proposed at this site are the same as the SITE I and SITE II.

Flow diagrams and design data for the intake facilities are illustrated in **Figures 5-1, 5-2, and 5-3** respectively for SITE I,

SITE II, and SITE III. Figure 5-4 shows the dimensions of the RWSB, and Figure 5-4 shows the layout for pump station II.

### **Operating Strategy of RWSB and FWDB**

The proposed RWSB can selectively withdraw raw water from the drainage ditch or from the proposed FWDB when floodwater is available in the basin. Water within the FWDB can be regulated to flow to the RWSB by gravity when the water level in the detention basin is higher than the water level in the RWSB, or flow to the wet well by gravity and pumped to the RWSB when the water level in the FWDB is lower than the water level in the RWSB. Screening will be required at the discharge to the wet well and RWSB from FWDB.

### **Water Quality Monitoring System**

A water quality monitoring system should be installed at the diversion site on the ditch to monitor the water quality conditions within the ditch in order to optimize treatment operations.

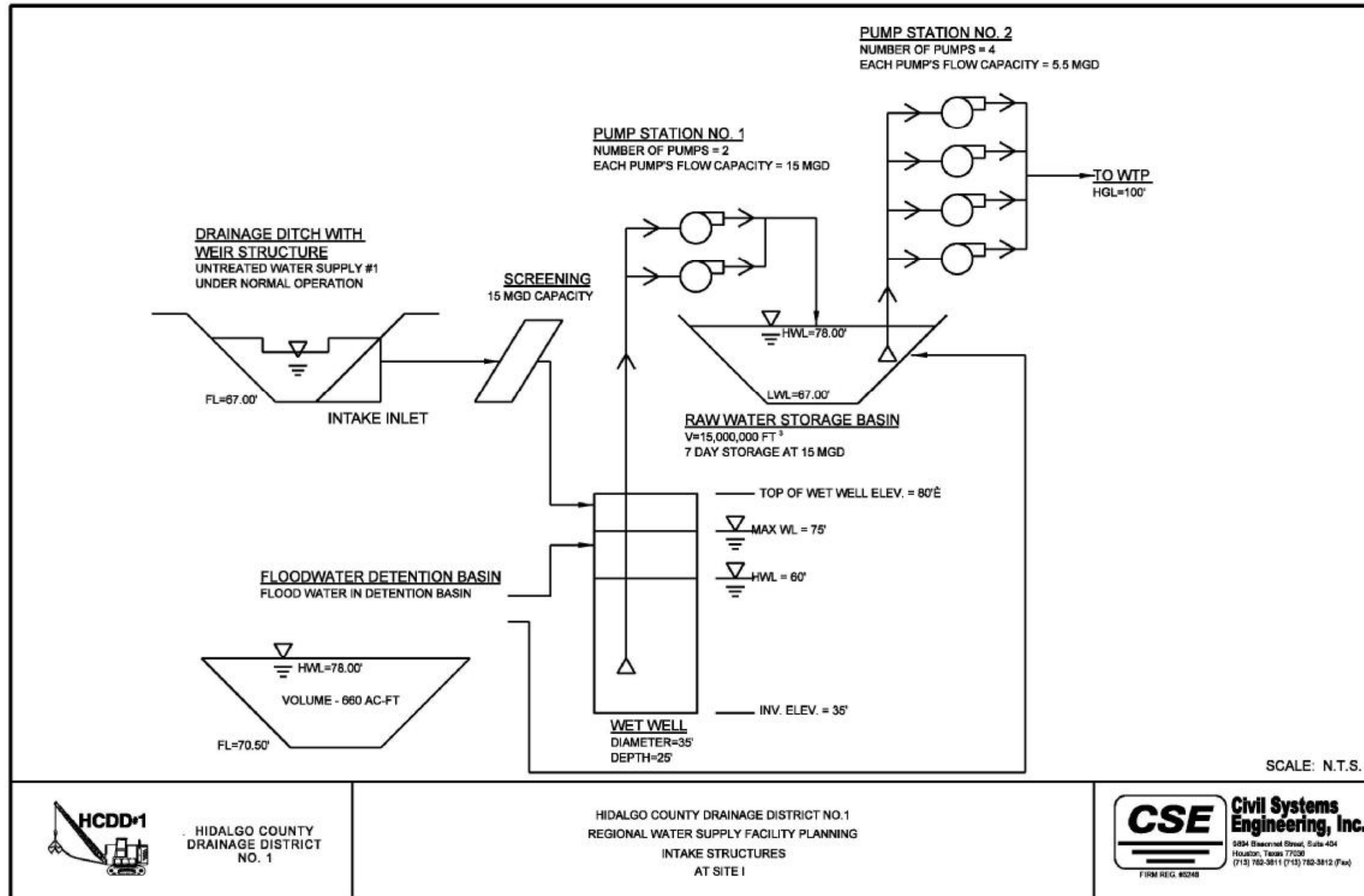

HIDALGO COUNTY  
DRAINAGE DISTRICT  
NO. 1

HIDALGO COUNTY DRAINAGE DISTRICT NO.1  
REGIONAL WATER SUPPLY FACILITY PLANNING  
INTAKE STRUCTURES  
AT SITE I



**Civil Systems  
Engineering, Inc.**  
8834 Elmwood Street, Suite 404  
Houston, Texas 77050  
(713) 762-3811 (713) 762-3812 (Fax)  
FIRM REG. #0248

Figure 5-1. Intake Structures and Design Data at SITE I

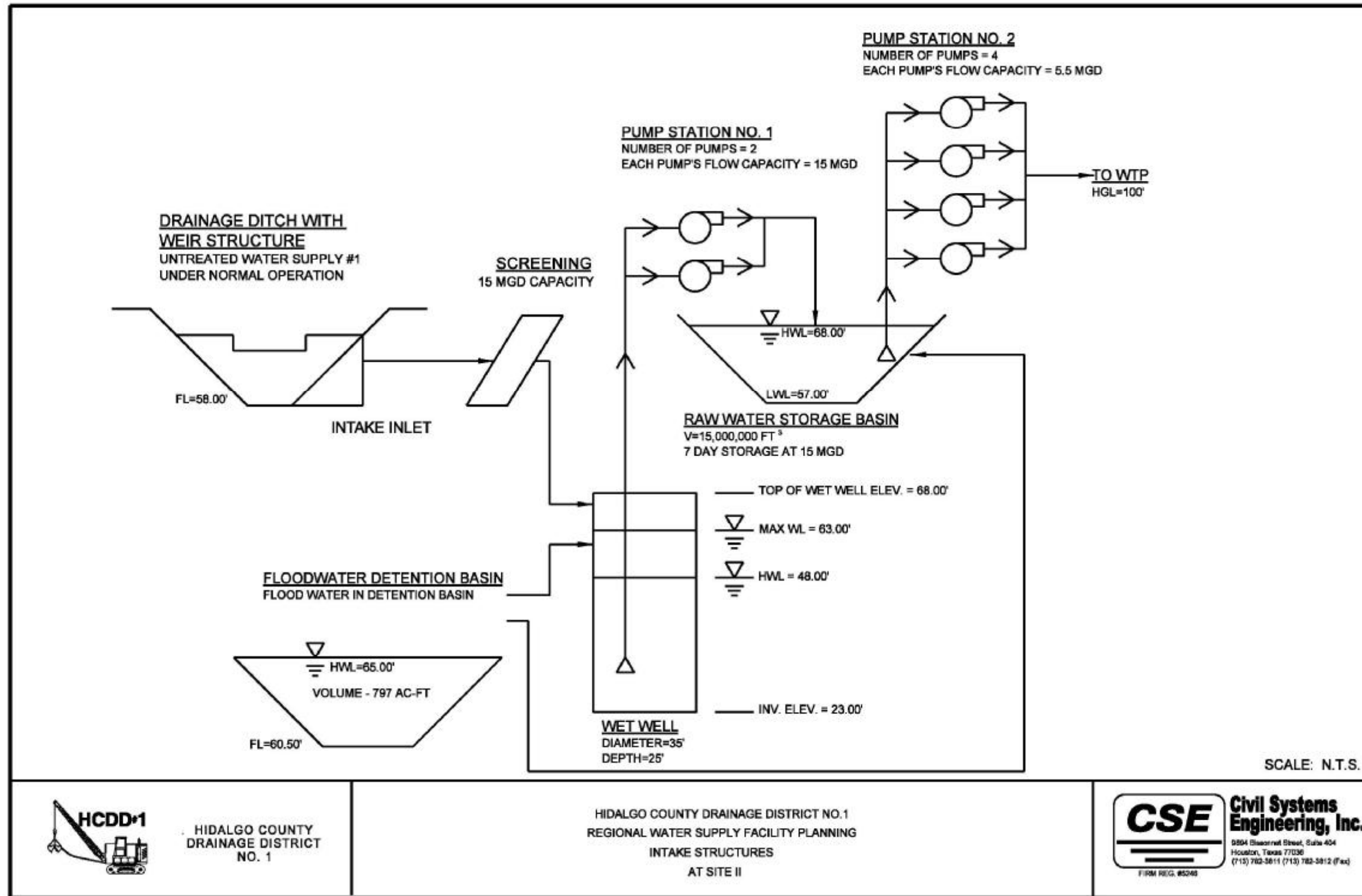

Figure 5-2. Intake Structures and Design Data at SITE II

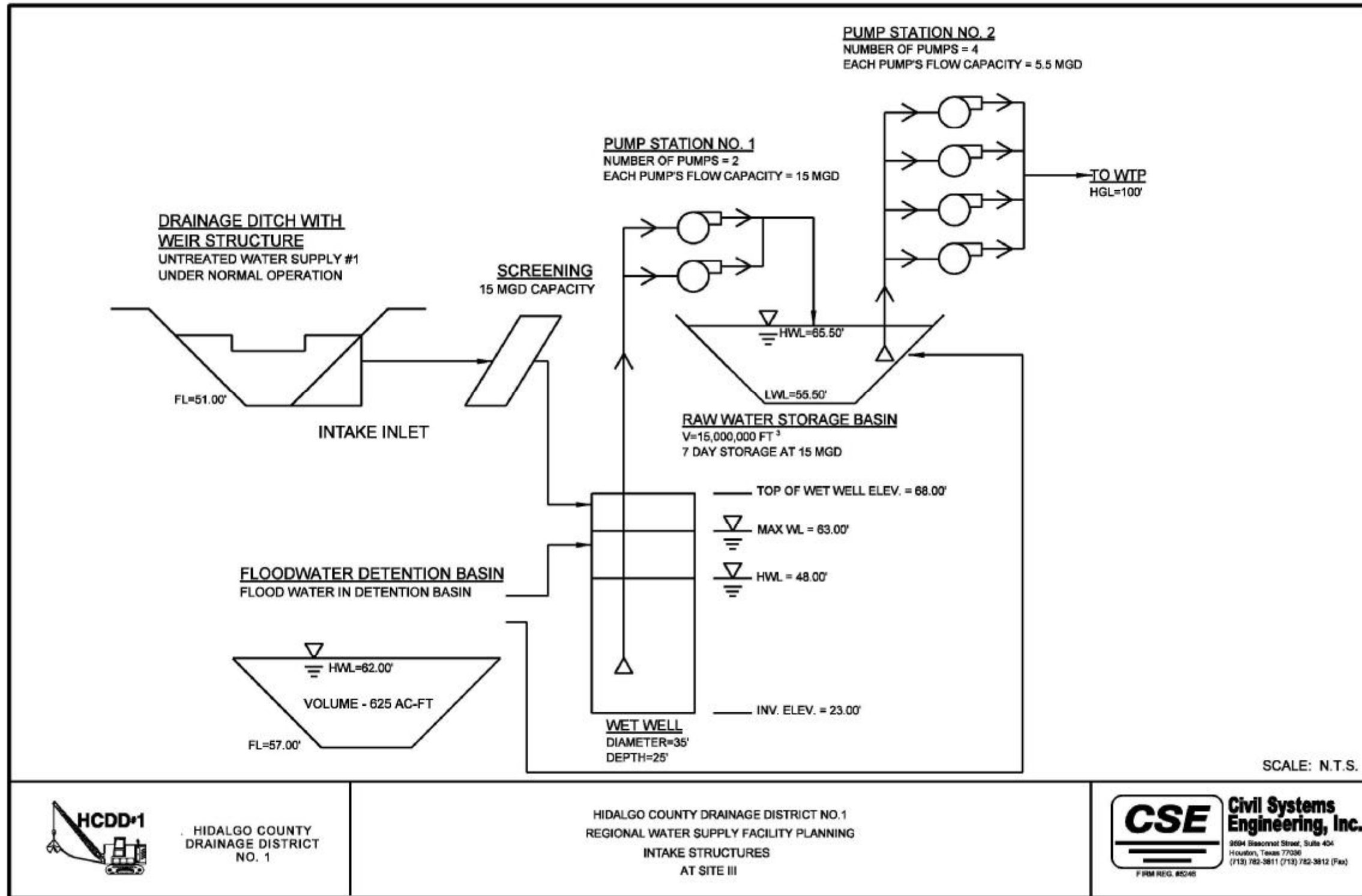

Figure 5-3. Intake Structures and Design Data at SITE III

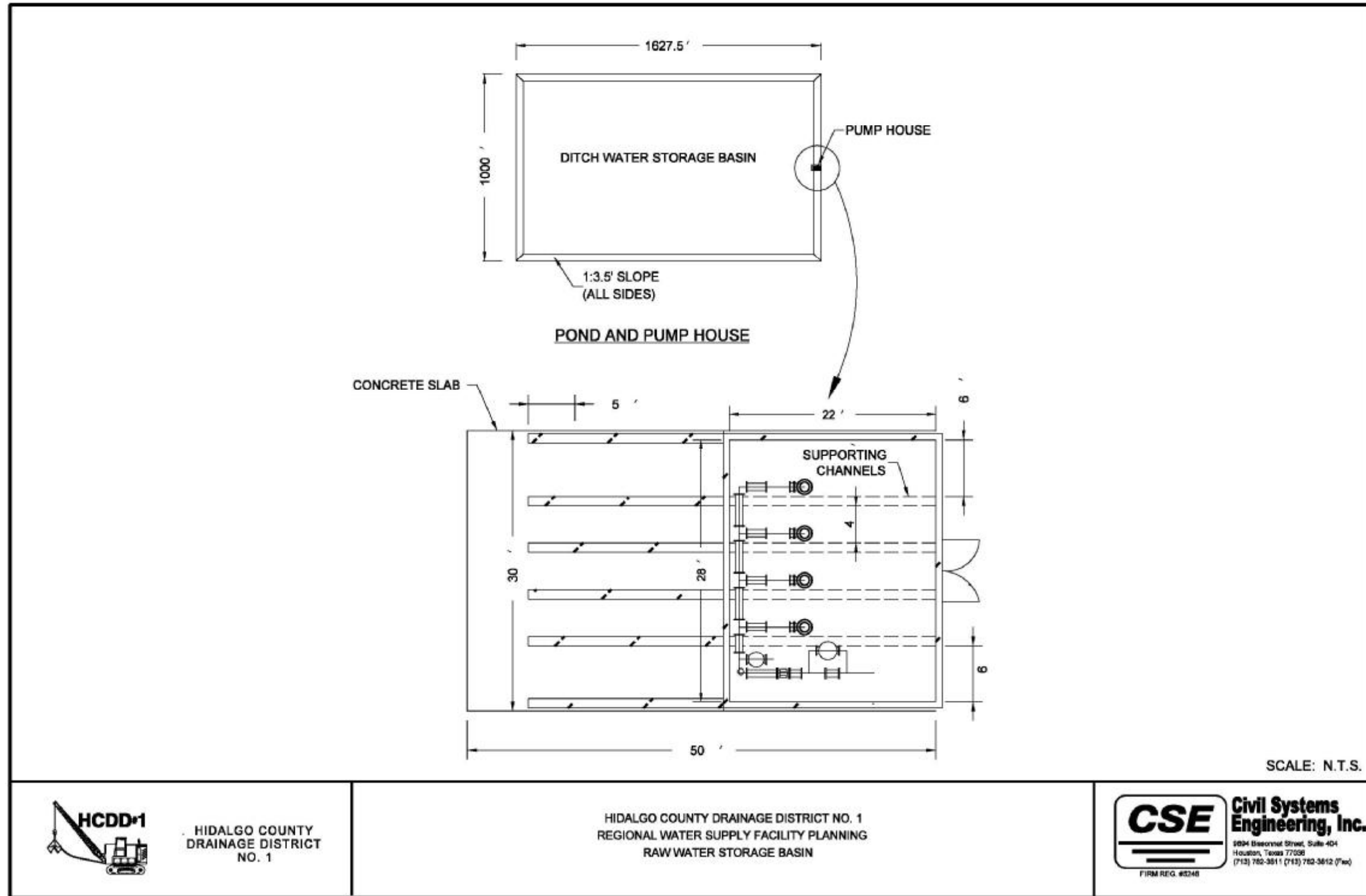

Figure 5-4. Raw Water Storage Basin

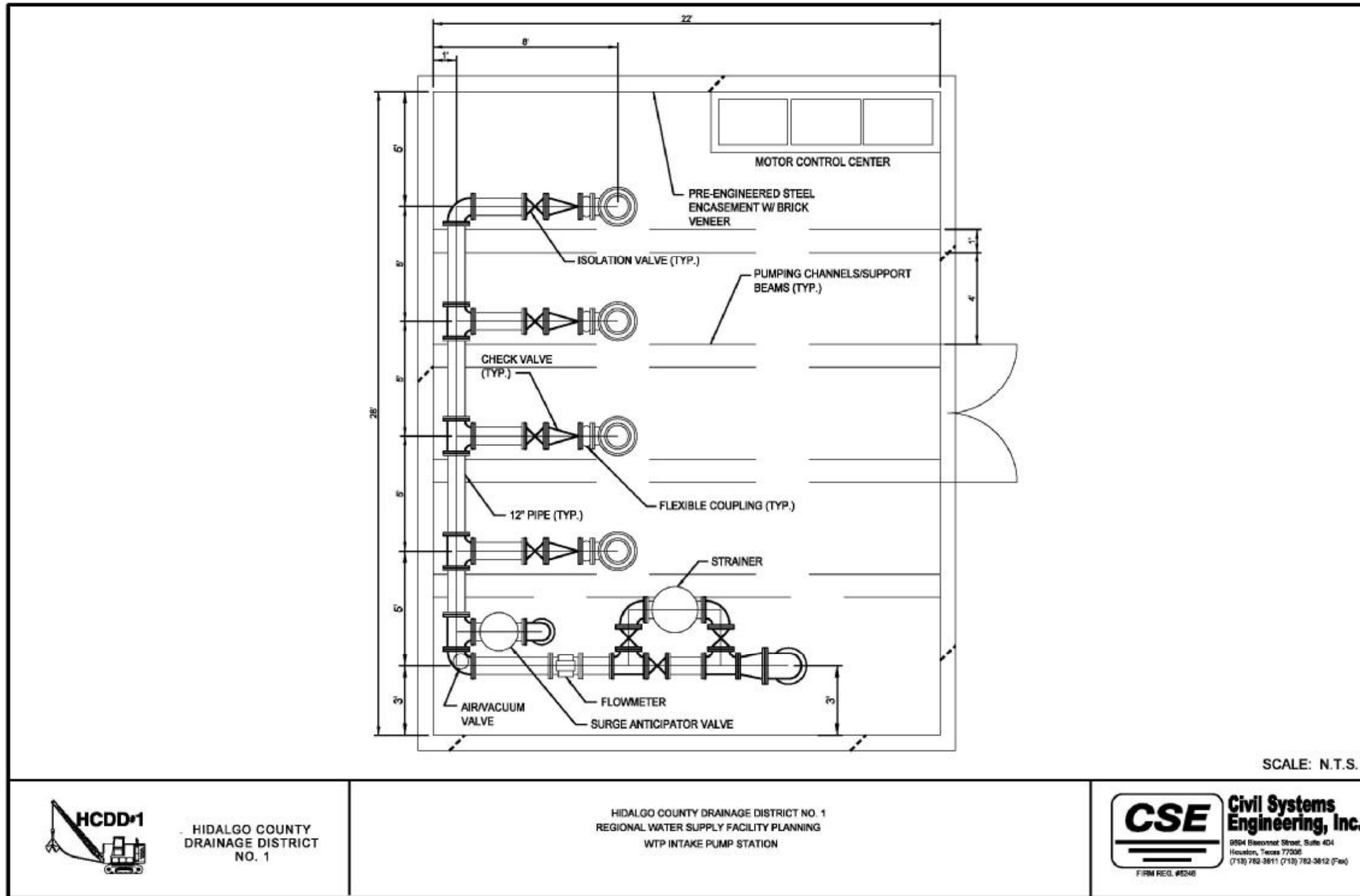

Figure 5-5. Pump Station II



## 6 Treatment Process Evaluation

There are a number of factors that must be considered in evaluating and selecting a drinking water treatment process, including untreated water quality (contaminants in the water), drinking water standards, size of treatment system, strengths and weakness of each process unit, and long-term costs.

### Source Water Quality

The water treatment process to be chosen greatly depends on the number and type of contaminants or aesthetic problems of the source water. For the purpose of this project, water quality samplings were performed at four (4) locations along the drainage ditches where proposed project sites were located to acquire untreated raw base flow water quality information. The four sampling locations are illustrated in **Figure 6-1**.

The collected water samples were tested at each project site to determine the levels of various contaminants in the untreated source water. **Table 6-1** summarizes the results of water sampling and analysis results are five (5) water quality parameters were identified to be key in evaluating and selecting the water treatment processes, including TDS, Hardness, Sodium, Sulfate, and TOC.

A brief description to each of the five parameters is given below.

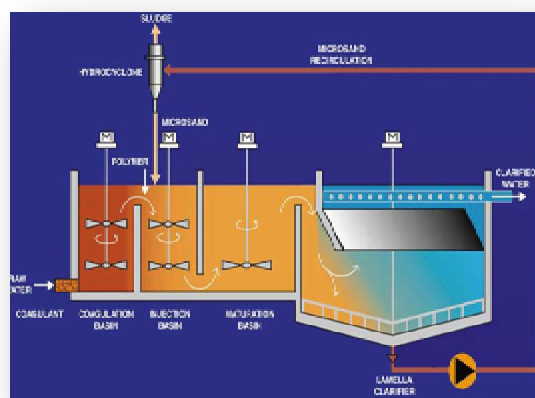

### Total Dissolved Solids (TDS)

The TDS concentrations, varying among the four sampling locations, are 2000 mg/L, 1700 mg/L, 1600 mg/L, and 1900 mg/L respectively at Location 1, Location 2, Location 3, and Location 4.

TDS does not have a set Maximum Contaminant Level (MCL) and is therefore not regulated by the Environmental Protection Agency (EPA). A Secondary MCL of 500 mg/L is set for TDS, but it is not an enforceable limit.

The raw water from the drainage ditch is considered moderately brackish. Brackish water generally has a TDS concentration of 1,000-10,000 mg/L. Water is considered fresh when its TDS concentration is below 500 mg/L.

### Hardness

The hardness concentrations are 600 mg/L as CaCO<sub>3</sub>, 520 mg/L as CaCO<sub>3</sub>, 610 mg/L as CaCO<sub>3</sub>, and 570 mg/L as CaCO<sub>3</sub> respectively at Location 1, Location 2, Location 3, and Location 4. The raw water is considered very hard based on classification by the U.S.

Department of Interior and the Water Association (>180 mg/L).

Detailed water sampling data and laboratory analysis report are included in **Appendix B** (attached CD-ROM).

Both US and the current American Water Works Association (AWWA) drinking water standards do not require hardness removal. Since the raw water is very hard. It is reasonable to provide some degree of acceptable hardness to the consumers. A total hardness of 80 to 100 mg/L as CaCO<sub>3</sub> was recommended.

A softening process is required to lower the hardness of the raw water. The benefits of the softening process include (1) reducing TDS and scale-formation tendencies, (2) reducing consumption of household cleaning agent, and (3) removing TOC.

#### Sodium

Sodium concentrations were determined as 460 mg/L, 410 mg/L, 420 mg/L, and 550 mg/L for respectively at Location 1, Location 2, Location 3, and Location 4. Sodium concentration is high in the untreated water.

#### Sulfate

Sulfate concentrations were determined as 510 mg/L, 430 mg/L, 380 mg/L, and 360 mg/L respectively at Location 1, Location 2, Location 3, and Location 4.

#### Total Organic Carbon (TOC)

TOC concentrations vary among the four sampling locations. They are 40 mg/L, 25 mg/L, 36 mg/L, and 78 mg/L respectively at Location 1, Location 2, Location 3, and Location 4.



Figure 6-1. Source Water Quality Sampling Locations

Table 6-1: Raw Water Sampling and Water Quality Parameters

Parameter	Unit	Untreated Water Quality			
		Site 1	Site 2	Site 3	Site 4
Color	Pt-Co units	30	30	40	30
Alkalinity (mg/L)	mg/L	120	140	230	180
Silica	mg/L as CaCO <sub>3</sub>	32	27	25	31
Hardness Total	mg/L as CaCO <sub>3</sub>	600	520	610	570
Sodium, Na	mg/L	460	410	420	500
Magnesium, Mg	mg/L	55	48	50	54
Calcium, Ca	mg/L	150	130	160	140
Potassium, K	mg/L	13	12	12	15
Chloride, Cl	mg/L	510	450	410	370
Aluminum, Al	mg/L	1.98	1.35	<0.1	1.68
Iron, Fe (Total and Dissolve)	mg/L	0.662(T), <0.05 (D)	0.630(T), <0.05(D)	4.49(T), <0.05(D)	0.952(T), <0.05(D)
Manganese, Mn (Total and Dissolved)	mg/L	<0.005 (T), <0.005(D)	<0.005(T), <0.005(D)	0.354 (T), <0.005(D)	<0.005(T), <0.005(D)
Total NO <sub>2</sub> <sup>-</sup> N, NO <sub>3</sub> <sup>-</sup> N	mg/L	6.3	5.467	4.382	6.45
Sulfate, SO <sub>4</sub>	mg/L	510	430	380	360
Total Organic Carbon (TOC)	mg/L	40	25	36	78
Bacterial Analysis	total plate count	55,000	25,000	51,000	40,000
Carbonate, CO <sub>3</sub>	mg/L	<1	<1	<1	<1
Bicarbonate, HCO <sub>3</sub> <sup>-</sup>	mg/L	120	140	230	180
Pesticides	mg/L				
Ammonium, NH <sub>3</sub> <sup>-</sup>	mg/L	0.16	0.116	0.177	0.151
Turbidity	NTU	13	11	60	17
Total Dissolved Solids (TDS)	mg/L	2000	1700	1600	1900
pH		7.62	7.8	7.81	7.73
Key Parameters					

## Finished Water Targets

The Safe Drinking Water Act (SDWA) is the main federal law that ensures the quality of drinking water. Under SDWA, set standards for drinking water quality and oversees the states, localities, and water suppliers who implement those standards.

### EPA and TCEQ Primary and Secondary Contaminant Levels

The Primary Drinking Water regulations of EPA and TCEQ are the same as summarized in **Appendix C** (attached CD-ROM), except that EPA has more primary minimum contaminant levels listed than TCEQ standard table. The Secondary Drinking Water regulations differ on four contaminant levels: Chloride, pH, Sulfate, and total Dissolved Solids.

Although the primary and secondary contaminant level regulations are quite comprehensive, to meet the minimum regulations and standards set by EPA and TCEQ, emphasis will be placed on the following key contaminants and standards for this project:

- § TTHM: Less than 0.08 mg/L per Stage 2 D/DBP Rule
- § HAA5: Less than 0.06 mg/L per Stage 2 D/DBP Rule
- § Iron: Less than 0.3 mg/L (State and National Secondary Drinking Water Standards)
- § Manganese: Less than 0.05 mg/L (State and National Secondary Drinking Water Standards)
- § Turbidity: 0.3 NTU
- § TDS: Less than 500 mg/L (State and National Secondary Drinking Water Standards)

### § TOT Removal (see Table 6-2) Major Treated Water Rules for Water Treatment Plant

Enhanced Coagulation Requirements (ECR) - The purpose is to add excess coagulant to remove total organic carbons (TOC) and reduce the formation of disinfection by-products. The guided criteria for ECR are the required TOC removal as shown in table below.

**Table 6-2. Required TOC Removal**

Source Water TOC, mg/L	Source Water Alkalinity (%)		
	0-60 mg/L	>60-120 mg/L	>120 mg/L
2 - 4	35	25	15
> 4 - 8	45	35	25
> 8	50	40	30

Long Term 2 Enhanced Surface Water Treatment Rule (LT2ESWTR) - The purpose of this rule is to reduce illness linked with the contaminant *Cryptosporidium* and other pathogenic microorganisms in drinking water. The LT2ESWTR will supplement existing regulations by targeting additional *Cryptosporidium* treatment requirements for higher risk systems. This rule also contains provisions to reduce risks from uncovered finished water reservoirs and provisions to ensure that systems maintain microbial protection when steps are taken to decrease the formation of disinfection byproducts that result from chemical water treatment. Rule requirements for water treatment include:

- (1) Monitoring: Under the LT2ESWTR, systems will monitor their water sources to determine treatment requirements. This monitoring includes an initial two years of monthly sampling for

***Cryptosporidium***. To reduce monitoring costs, small filtered water systems will first monitor for *E. coli*—bacterium which is less expensive to analyze than ***Cryptosporidium***—and will monitor for *Cryptosporidium* only if their *E. coli* results exceed specified concentration levels.

(2) ***Cryptosporidium*** treatment: Filtered water systems will be classified in one of four treatment categories (bins) based on their monitoring results. The majority of systems will be classified in the lowest treatment bin, which carries no additional treatment requirements. Systems classified in higher treatment bins must provide 90 to 99.7 percent (1.0 to 2.5-log) additional treatment for ***Cryptosporidium***. Systems will select from a wide range of treatment and management strategies in the "microbial toolbox" to meet their additional treatment requirements. All unfiltered water systems must provide at least 99 or 99.9 percent (2 or 3-log) inactivation of *Cryptosporidium*, depending on the results of their monitoring. These ***Cryptosporidium*** treatment requirements reflect consensus recommendations of the Stage 2 Microbial and Disinfection Byproducts Federal Advisory Committee.

(3) Other requirements: Systems that store treated water in open reservoirs must either cover the reservoir or treat the reservoir discharge to inactivate 4-log virus, 3-log *Giardia lamblia*, and 2-log ***Cryptosporidium***. These requirements are necessary to protect

against the contamination of water that occurs in open reservoirs. In addition, systems must review their current level of microbial treatment before making a significant change in their disinfection practice. This review will assist systems in maintaining protection against microbial pathogens as they take steps to reduce the formation of disinfection byproducts under the Stage 2 Disinfection Byproducts Rule, which the EPA is finalizing along with the LT2ESWTR.

*Ground Water Rule* - The purpose of this rule is to reduce the risk of exposure to fecal contamination that may be present in public water systems that use ground water sources. Rule requirements include:

(1) Periodic sanitary surveys of ground water systems that require the evaluation of eight critical elements and the identification of significant deficiencies (e.g., a well located near a leaking septic system). States must complete the initial survey by December 31, 2012 for most community water systems (CWSs) and by December 31, 2014 for CWSs with outstanding performance and for all non-community water systems.

(2) Source water monitoring is required to test for the presence of *E. coli*, enterococci, or coliphage in the sample. There are two monitoring provisions: (a) Triggered monitoring for systems that do not already provide treatment that achieves at least 99.99 percent (4-log) inactivation or removal of viruses and that have a total coliform-positive

routine sample under Total Coliform Rule sampling in the distribution system.

(3) Assessment monitoring - As a complement to triggered monitoring, a State has the option to require systems, at any time, to conduct source water assessment monitoring to help identify high risk systems.

(4) Corrective actions are required for any system with a significant deficiency or source water fecal contamination. The system must implement one or more of the following correction action options: (a) Correct all significant deficiencies, (b) Eliminate the source of contamination, (c) Provide an alternate source of water, or (d) Provide treatment which reliably achieves 99.99 percent (4-log) inactivation or removal of viruses.

(5) Compliance monitoring to ensure that treatment technology installed to treat drinking water reliably achieves at least 99.99 percent (4-log) inactivation or removal of viruses.

Stage 2 Disinfectants and Disinfection Byproduct Rule - The purpose of this rule is to reduce potential cancer and reproductive and developmental health risks from disinfection byproducts (DBPs) in drinking water, which form when disinfectants are used to control microbial pathogens. Over 260 million individuals are exposed to DBPs. Rule requirements include:

(1) Systems need to have an evaluation of their distribution systems, known as

an Initial Distribution System Evaluation (IDSE), to identify the locations with high disinfection byproduct concentrations. These locations will then be used by the systems as the sampling sites for Stage 2 DBP rule compliance monitoring.

(2) Compliance with the maximum contaminant levels for two groups of disinfection byproducts (TTHM and HAA5) need to be calculated for each monitoring location in the distribution system. This approach, referred to as the locational running annual average (LRAA), differs from current requirements which determine compliance by calculating the running annual average of samples from all monitoring locations across the system.

(3) Each system is required to determine if it has exceeded an operational evaluation level, which is identified using the compliance monitoring results. The operational evaluation level provides an early warning of future MCL violations, which allows the system to take proactive steps to remain in compliance. A system that exceeds an operational evaluation level is required to review their operational practices and submit a report to the state that identifies actions that may be taken to mitigate future high DBP levels, particularly those that may jeopardize its compliance with the DBP MCLs.

Total Coliform Rule - The purpose of this rule is to improve public health protection by reducing fecal pathogens

to minimal levels through control of total coliform bacteria, including fecal coliforms and *Escherichia coli* (E. Coli). Rule requirements include routine sample requirements, repeat sampling requirements, and additional routine sample requirements:

*Filter Backwash Recycling Rule (FBRR)*

- The purpose of this rule is to improve public health protection by assessing and changing, where needed, recycle practices for improved contaminate control, particularly microbial contaminants. Rule requirements include reporting, recycle return location, and recordkeeping.

*Lead and Copper Rule (LCR)*

- The purpose of this rule is to protect public water system consumers from exposure to lead and copper in drinking water. The revisions to the LCR will: Enhance the implementation of the LCR in the areas of monitoring, treatment, customer awareness and lead service line replacement. Improve compliance with the public education requirements of the LCR and ensure drinking water consumers receive meaningful, timely, and useful information needed to help them limit their exposure to lead in drinking water.

A summary of applicable rules and regulations are as follows:

- § Long Term 1 Enhanced Surface Water Treatment Rule (LT1 Rule)
  - § Long term 2 Enhanced Surface Water Treatment Rule (LT2 Rule)
  - § Enhanced Coagulation Requirements (ECR)
  - § Stage 1 Disinfectants and Disinfection Byproducts Rule (Stage 1 D/DBPR)
  - § Stage 2 Disinfectants and Disinfection Byproducts Rule (Stage 2 D/DBPR)
  - § Arsenic Rule
  - § Lead and Copper Rule
  - § Radionuclide Rule
  - § Total Coliform Rule
- § Safe Drinking Water Act (SDWA) – Principal Federal Law
  - § EPA Primary Drinking Water Regulations
  - § EPA Secondary Drinking Water Standards
  - § Title 30 Texas Administrative Code, Chapter 290



## Water Treatment Technologies

Drinking water treatment requires a multi-barrier approach to ensure treated water meets federal and state drinking water quality regulations. Each treatment barrier provides an additional step to add safety to the drinking water. The effectiveness is cumulative. Each unit process helps the subsequent unit process work more effectively than if operated alone. The primary multiple drinking water treatment barriers include coagulation/flocculation, sedimentation, filtration, and disinfection.

### Coagulation/Flocculation

The first step in water treatment is coagulation. The coagulation is a necessary step to reduce the organics and turbidity in the water consists of a rapid mixing with coagulant addition. Particles and organics in natural water systems are negatively charged. The purpose of the rapid mixer is to achieve the initial contact between the water and coagulant added to the water to form the positively charged coagulant complexes that neutralize (destabilize) the negatively charged particles.

Flocculation is the process of producing interparticle contacts, which is defined as the bonding of coagulated particles following the removal of forces that kept them apart, i.e. coagulation. Once the negatively charged particles in the water have been destabilized, these particles begin to stick together and form floc. As more particles stick together, the floc grows and becomes dense enough to settle from the water as sludge in the clarification (or sedimentation) step. In most cases, a flocculent is used after the

addition of a coagulant to enhance floc formation and to increase the strength of the floc structure. Sometimes, the flocculent is also called a coagulant aid.

As discussed earlier, the raw water supply source for this project is from drainage water in the existing drainage ditches of Hidalgo County Drainage District No.1. The suspended solids could be very high during flood events. Also, the particles in the raw water contain colloids, dissolved solids, bacteria, and other organisms. The characteristics of the raw water supply require more efficient formation of large particles in the coagulation and flocculation process.

### Sedimentation

Sedimentation (or clarification) is a physical water treatment process used to settle out the floc formed in the coagulation/flocculation process by gravity. Clarification has been used at water treatment plants (WTPs) for many years as an effective means to treatment to produce a clarified effluent for further treatment by filtration. The primary parameter for conventional sedimentation basin design is the acceptable surface loading rate (hydraulic overflow rate). Surface loading rates are normally very low to achieve proper operation and an acceptable effluent. Typical hydraulic overflow rate for conventional sedimentation ranges from 800 to 1,200 gpd per ft<sup>2</sup>. Conventional sedimentation usually utilizes very large basins and has long detention times (3 to 4 hours for gravity settling).

Several high-rate clarification processes were investigated for primary clarification, including:

- § Tube settlers
- § Plate settlers
- § Sludge blanket clarifier
- § ACTIFLO

The hydraulic overflow rates for the four high-rate clarification processes are 2,880, 2,880-8,640, 2,880-7,200, and 21,600-28,800 gpd/ft<sup>2</sup>, respectively. ACTIFLO has the highest hydraulic overflow rate, which is more than 30 times of the conventional sedimentation hydraulic overflow rate. Using ACTIFLO technology will significantly reduce the construction costs of the sedimentation basin.

ACTIFLO is a proven, compact, clarification system that utilizes microsand enhanced flocculation and lamellar settling to produce high quality, filterable effluent. The microsand improves both the flocculation through its large specific surface and the sedimentation through its high specific density.

ACTIFLO process consists of a rapid mix in which a coagulant is added, followed by an injection tank, where micro-sand and a polymer are added in a high energy mixing environment. Following this is a maturation zone. The detention time for all these steps is about 6 minutes. The water then enters the settling tank where the micro-sand flocs settle out quickly.

Advantages of ACTIFLO process include very high loading rates (up to 30 gpm/ft<sup>2</sup>) that can significantly reduce surface area requirements. The system is very flexible in handling extreme flow variations with a wide range of turbidity and organics levels. The process is quick to respond to changing conditions

and have a range of "forgiveness" if chemical dosages are not precisely known. The process consistently displays efficient removals of turbidity, color, TOC, algae, particle counts, cryptosporidium, iron, manganese, arsenic and other typical undesirable water contaminants from raw waters.

In summary, the benefits of using ACTIFLO include small footprint, high performance, stability and ability to treat variations in influent quality, flexibility, reliability, rapid start up, reduced chemical consumption, and reduced costs. **Figure 6-2** illustrates the ACTIFLO settling process.

The EPA's Disinfectants and Disinfection By-Products Rule requires enhanced coagulation to remove a specified percentage of organic material from the source water measured by TOC as shown in **Table 6-2**. The use of ACTIFLO process will meet or exceed the EPA TOC removal requirement. ACTIFLO process has a 95-99% removal rate of turbidity in raw water influent with a turbidity of 0-2000 NTU. ACTIFLO process was recommended as a pretreatment process for this project.

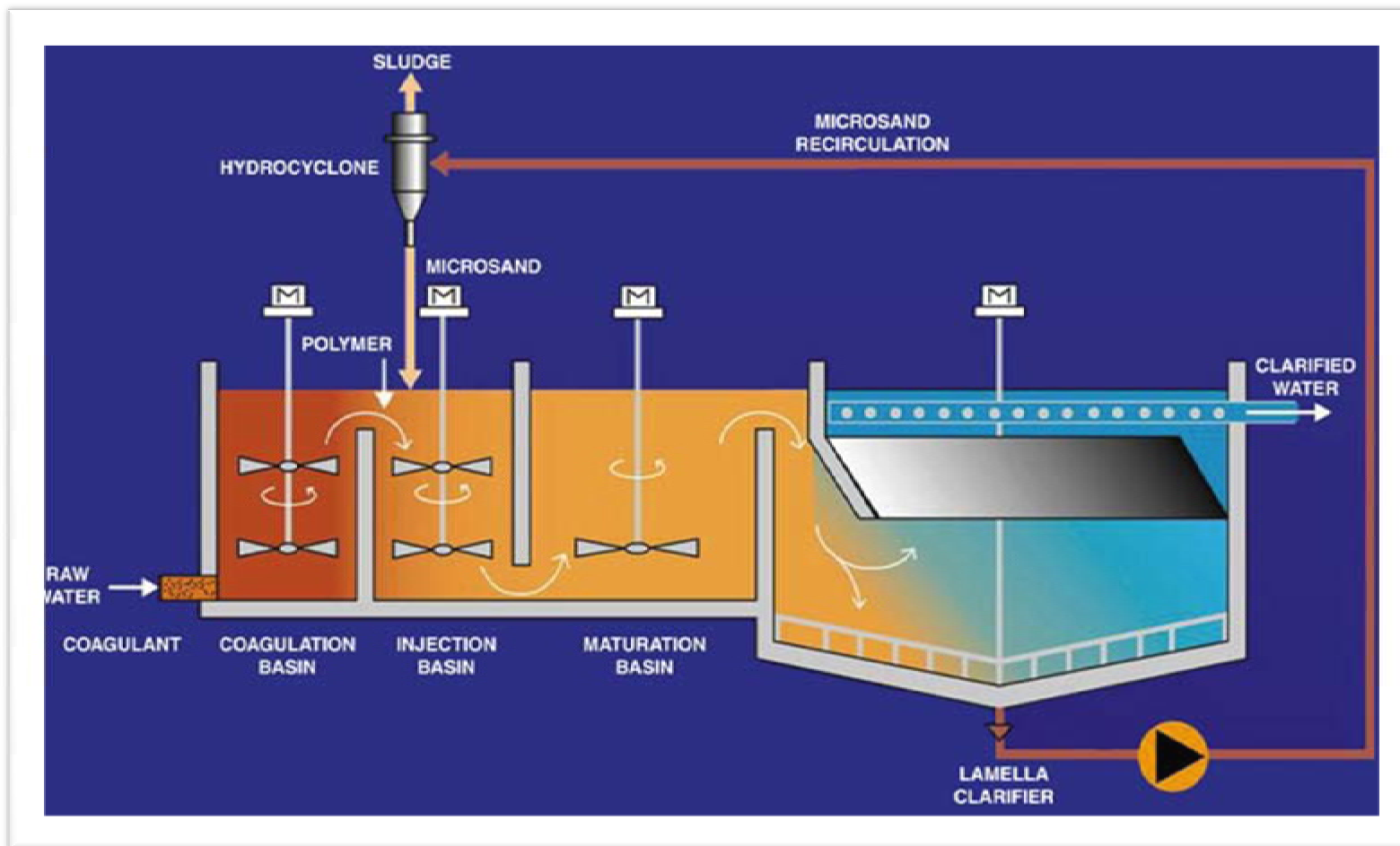

Figure 6-2. ACTIFLO® Process

### Filtration Technologies

Filtration is a required process after coagulation/flocculation. Coagulation, flocculation, and sedimentation processes are not sufficient to remove all particles and flocs from water. Filtration process is required to remove additional suspended solids and associated contaminants from water. The filtration technologies considered in this project are granular media filters or membranes.

*Granular Media Filters* - The most common filtration is granular media filtration and dual media filters (DMF) are the most common filters found at water treatment plants today. With consideration of the untreated water quality and objectives of this project, the dual-media filter was considered and evaluated for this project.

DMF, like other conventional granular media filtration, is a simple mechanical process, actually involves the mechanisms of adsorption (physical and chemical), straining, sedimentation, interception, diffusion, and inertial compaction. It uses two layers, a top one of anthracite and a bottom one of sand, to remove turbidity and suspended solids. DMF does not remove dissolved solids.

With consideration of the high level of contaminant contents in the raw water in terms of high levels of TDS, hardness, and TOC, DMF alone could not meet all the finished water requirements. However, DMF can be applied in conjunction with membrane technologies such as RO or Nanofiltration (NF), which function as a pretreatment process.

*Membrane Filtration* - The membrane filtration is a technique which uses a semipermeable membrane for removing suspended and dissolved solids from water. The principle is quite simple: the membrane acts as a very specific filter that will let water flow through, while it catches suspended solids and other substances. Most membrane filtration processes currently used in the water treatment are pressure driven technology with pore sizes ranging from 100 molecular weight to 5 microns. Membrane processes have become more attractive for drinking water treatment in recent years due to the increased stringency of drinking water regulations. Microfiltration (MF), ultrafiltration (UF), nanofiltration (NF), and reverse osmosis (RO) are all membrane filtration techniques having applications in drinking water treatment.

Microfiltration (MF) is a low pressure means of separating large molecular weight suspended or colloidal compounds from dissolved solids. It is the most popular type of membrane filter and removes particle size of approximately 0.1  $\mu\text{m}$  and larger in diameter. MF usually employs a pore size of 0.2  $\mu\text{m}$  for water treatment and generally requires a driving pressure of 30 to 40 psi. MF does not have small enough pores to remove TDS or salts as chloride, viruses and disinfection byproducts, and is typically used as a pretreatment process for water treatment.

Ultrafiltration (UF) is also a low pressure driven membrane separation process that separates particulate matter from soluble components in the water. UF membranes typically have pore sizes in the range of 0.01 - 0.10  $\mu\text{m}$  and have a high removal capability for colloids,

bacteria, virus, and high-molecular-weight organic compounds. UF generally requires a driving pressure ranging from 10 to 40 psi for drinking water treatment. Like MF, UF does not effectively remove TDS or salts, disinfection byproducts and is typically used as a pretreatment process for water treatment.

Nanofiltration (NF) membranes have a nominal pore size of approximately 0.001 microns. A frequent application of NF membrane is to produce drinking water from water sources where TDS is too high to meet drinking water standards. NF membrane can be used to replace lime softening process because selected NF membranes can reduce hardness (calcium and magnesium). NF can more efficiently remove divalent versus monovalent ions, which are sometimes called "softening membranes." NF membranes can also remove TOC without generating undesirable chemical compounds such as chlorinated hydrocarbons produced by chlorine oxidation processes. NF membranes also have certain desalting capability to remove some dissolved salts.

NF generally requires a driving pressure ranging from 70- to 150 psi for drinking water treatment. More energy is required for NF than MF or UF. Due to the high levels of particles and TOC in the raw water, in order to operate NF on surface water, the feed water must be pretreated with conventional filtration treatment such as DMF or equivalent such as MF or UF.

Reverse Osmosis (RO) is a high pressure means for water treatment. RO can reduce the same constituents that NF

can, as well as salinity. It can effectively remove nearly all inorganic contaminants from water. The process is relatively insensitive to flow and TDS level. RO System capacity depends on the water temperature, TDS in feed water, operating pressure and the overall recovery of the system. The required pressure requirement for RO is greater than 300 psi. The system requires high capital and operating costs. Like NF, to apply RO system on surface water, the feed water must be pretreated with conventional treatment or equivalent.

**Figure 6-3** shows the pressure-driven membrane application guide, and **Figure 6-4** illustrates the effectiveness of membrane filtration techniques.

#### Integrated Membrane Systems (IMS)

To meet the water quality requirements, membranes are often employed within a multi-process water treatment system, which are referred to as integrated membrane systems. There are many integrated membrane systems with various combination of treatment processes. For the purpose of this project, the following two IMS were considered and evaluated:

- A. Dual Media Filtration followed by Nanofiltration (NF)
- B. Dual Media Filtration followed by Reverse Osmosis (RO).

*Dual Media Filtration and Nanofiltration:* This integrated membrane system (DMF+NF) would be a cost-effective solution to this project based on the untreated water quality conditions. This process involves treating the raw water to a high level of purity with the NF process, enabling blending of the permeate with treated

water from the DMF to reduce the quantity of water that must be treated by the NF system. The DMF functions as a pretreatment process for the NF process. Following the DMF, some of the water is applied to the NF membranes with some bypassing the NF system to be blended. The bypass is used since 100 percent will not be required to meet the finished water requirements. The proposed blending will significantly reduce chemical usage, and operating and capital costs, and provide a better finished water quality than the DMF alone. With this IMS operating at a blending ratio of 70% NF and 30% DMF., it is expected to have a TDS level of 500 mg/L to 1,000 mg/L of the finished water.

*Dual Media Filtration and Reverse Osmosis:* This integrated membrane system would be another cost-effective solution. With consideration of the high cost of RO system, a Low-Pressure Reverse Osmosis (LPRO) was recommended. LPRO system is different from traditional RO system by its requirement of low driving force. The driving pressure can be as low as 125 to 300 psi.

Like the DMF+NF option,. this process involves treating the raw water to a high level of purity with the RO system, enabling blending of the permeate with treated water from the DMF to reduce the quantity of water that must be treated by the RO system. It is expected to have a TDS level of 500 mg/L to 600 mg/L of the finished water with this integrated process at a blending ratio of 50% NF and 50% DMF

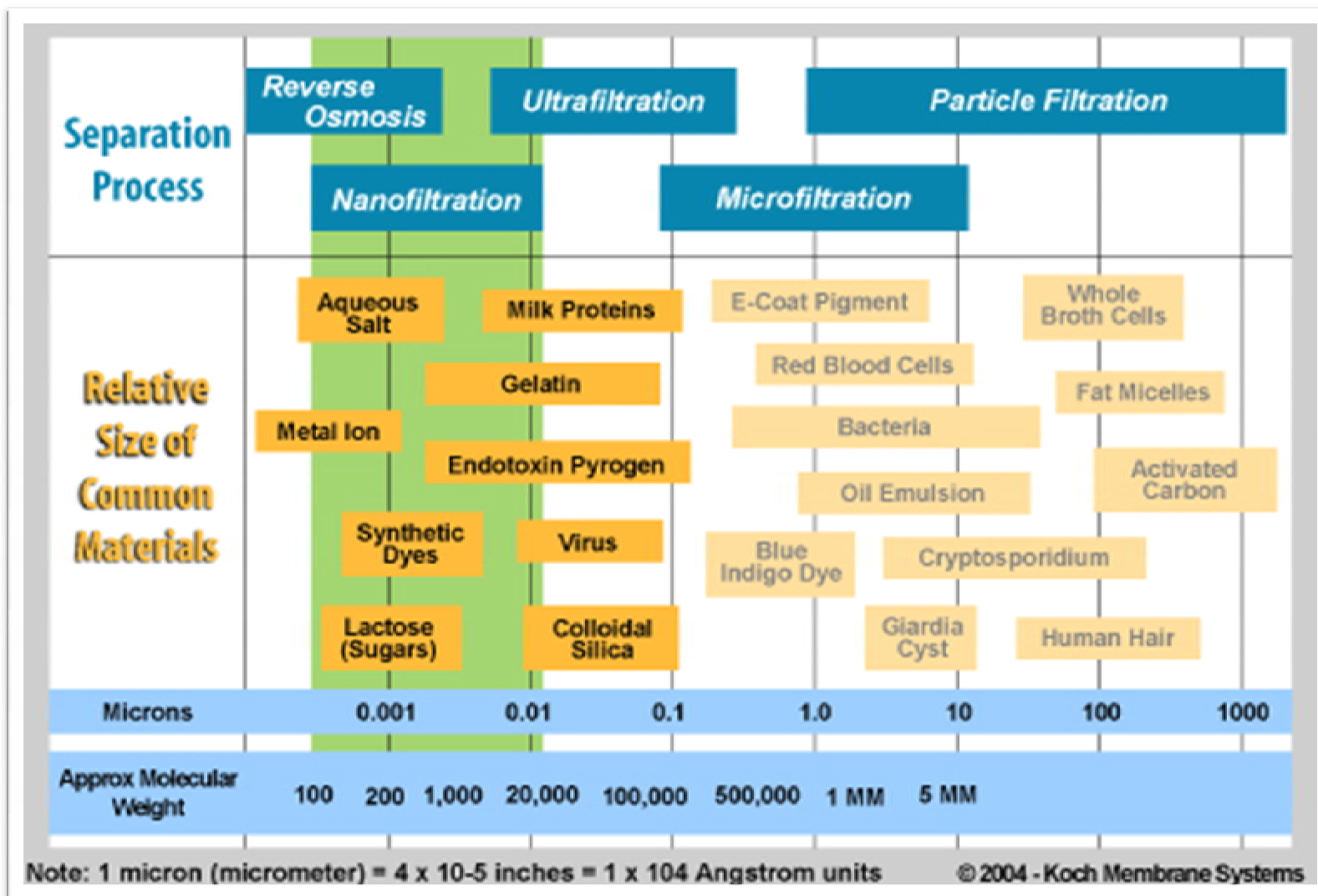

Figure 6-3. Pressure-Driven Membrane Process Application Guide

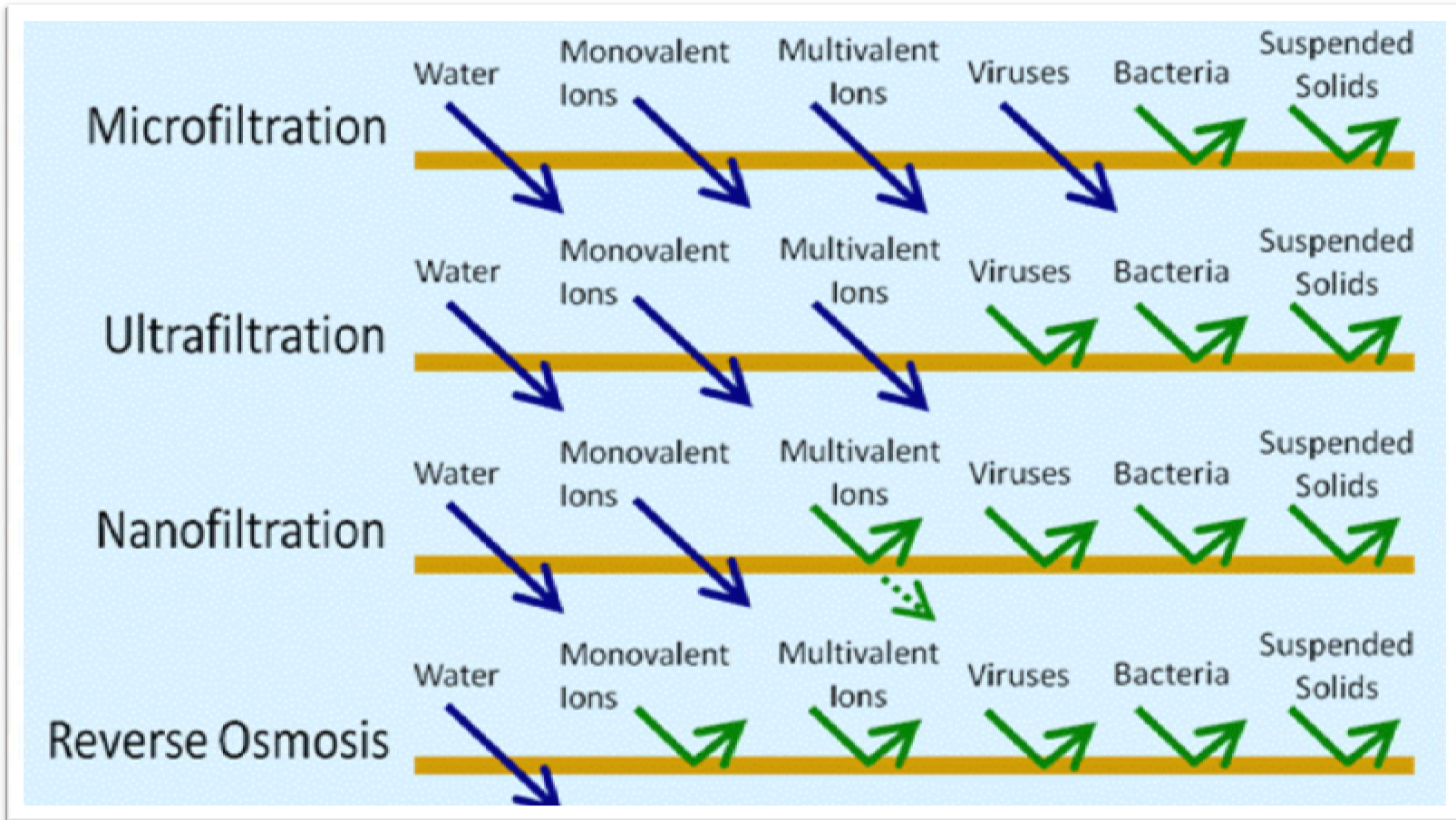

Figure 6-4. Effectiveness of Pressure-Driven Membrane Processes



## Disinfection

The final water treatment process is the disinfection process. A disinfection system is required in a drinking water treatment process in order to prevent waterborne diseases and microbial contamination. Disinfection is the process by which pathogens in the water are inactivated or rendered harmless by the use of chemicals, such as chlorine or physical processes such as UV.

Under the regulation of the Surface Water Treatment Rule (SWTR), the disinfection system must be designed to meet minimum requirements of residual concentration  $C$  of a disinfectant in mg/L, multiplied by the contact time  $T$  in minutes, which is termed as  $CT$ . The level of  $CT$  required for disinfection varies as a function of the type of disinfectant. Inactivation within a treatment system is often termed primary disinfection. Secondary or residual disinfection is the process of maintaining a disinfectant residual within the water distribution system to provide disinfecting environment and to compact accidental contamination with pathogens.

In drinking water treatment, disinfectants commonly used disinfection materials used as primary disinfectants include chlorine (gas & liquid), chloramines (liquid), ozone, and ultraviolet light (UV)

Chlorine and UV systems were evaluated for this project with consideration of construction costs, ease of operation, and location of the construction site.

### *Chlorine*

Chlorination has been practiced in water treatment since the early 1900s as an effective disinfectant for the protection of public health against waterborne diseases. It is relatively inexpensive and provides a residual concentration in a distribution system. Today it is the most commonly used disinfectant in water treatment. Chlorine was considered as the first choice of disinfection for this project. There are three sources of chlorine supplies, commercial grade hypochlorite, on-site hypochlorite generation, and gas chlorine.

*A commercial sodium hypochlorite system* is a chemical feed system with tanks and metering pumps. It is relatively easy to operate and maintain and does not require substantial operator attendance. Sodium hypochlorite is typically supplied as 12 to 15 percent solution. The solution degrades over time, losing some of its disinfection strength and forming chlorate ions in the solution. The following factors could cause a more rapid degradation of the solution: (1) high hypochlorite concentrations, (2) high temperatures, (3) presence of iron, copper, nickel, and cobalt, and (4) exposure to light. Sodium hypochlorite solutions are most stable at a pH of 11, stored in the dark at temperatures less than 70°F, and with iron, copper, nickel and cobalt concentrations less than 0.5 mg/L.

Storage systems are typically sized for a 30-day supply to safeguard against excess chemical degradation. The need for frequent deliveries and limited storage capabilities increase the risk of interrupted supply. In addition, the delivered chemical will be stored and transported under unknown conditions

and the degree of degradation that occurs prior to arrival is unknown. Thus, receiving a product from week to week with consistent quality is not guaranteed when using commercially available hypochlorite. Maintaining the solution at 70° F requires a climate controlled building for the storage tanks.

Commercial sodium hypochlorite is produced from caustic soda, water, and chlorine. The pH is generally greater than 11 and can be as high as 13. Scaling of equipment can be a problem due to the presence of caustic and appropriate maintenance and cleaning is required. In particular, feed points require frequent cleaning to ensure delivery of the chemical. Although commercial hypochlorite is safer than chlorine gas, it is highly corrosive, posing a threat to equipment and safety. The EPA requires that secondary containment be provided for hypochlorite concentrations greater than one percent.

In addition to operational and maintenance problems due to scaling, commercial sodium hypochlorite also yields off-gases oxygen. These gases can cause binding in the chemical feed lines and metering pumps. Special design features are necessary to avoid these problems, including the use of peristaltic hose pumps rather than diaphragm pumps for chemical metering.

*On-site generation of sodium hypochlorite* has been widely used in the United States and Europe for more than 20 years. On-site generation of sodium hypochlorite requires relatively large capital expenditures to purchase the electrolytic cells and rectifiers. On-site

generated sodium hypochlorite is produced on an as-needed basis by electrolysis systems utilizing salt, electricity, and softened water. One equivalent pound of chlorine is produced from 15 gallons of softened water, 1.9 pounds of salt, and 1.8 kilowatt-hours of electricity. Because of the low concentration (approximately 0.8% by weight) of sodium hypochlorite produced by on-site generated systems coupled with minimal storage times, the degradation problems of commercial sodium hypochlorite are significantly reduced. In addition, the recent technological advances in the generation of sodium hypochlorite allow for easier operation and maintenance. Typical maintenance would include cleaning the electrodes with a muriatic acid solution twice per year to remove minerals that have “plated-out” onto the cells.

On-site generation produces 0.8 percent sodium hypochlorite that is substantially less corrosive than commercial hypochlorite, thereby posing less threat to workers and equipment and negating the need for secondary containment. Sodium hypochlorite generation produces a by-product of hydrogen gas that is potentially explosive. The quantity produced, however, is not great and the hydrogen gas is easily vented from the equipment, buildings and storage tanks. Because hydrogen gas is lighter than air, conditions where the hydrogen gas could collect in pockets should be avoided. Standard design of on-site generation systems includes venting the hydrogen from the storage tanks and equipment building to the atmosphere where it quickly disperses.

*Chlorine gas disinfection systems* have demonstrated reliability in thousands of

installations across the United States and abroad for almost 100 years. However, the cost advantage of chlorine gas systems over other forms of chlorine for disinfection has decreased substantially in recent years due primarily to increased costs resulting from the adoption of new regulations i.e., Uniform Fire Code and Risk Management Program (RMP) and increased material costs.

Because of safety concerns related to potential accidental releases of chlorine gas during transport and storage, new and stricter federal regulations have been adopted. These regulations have resulted in a substantial increase in the cost of chlorine gas systems. The same quality that makes chlorine gas a good disinfectant also makes it extremely toxic to humans. Although new safety measures are currently in effect, there are still risks associated with the use and transportation of chlorine gas. It is also important to note that the transportation of chlorine gas is highly regulated, and requires special transportation permits and licensing. The trend toward more regulations regarding the transportation and storage of chlorine gas may continue, resulting in increased cost and difficulties associated with its use.

Based on previous similar project experience, for comparison purpose, probable cost estimates were developed and compared for the three chlorine disinfection systems as shown in **Table 6-3**. An on-site hypochlorite generator has the lowest cost for a chlorine disinfection feed system. The on-site hypochlorite generation system was recommended for this project.

**Figure 6-5** shows a typical chlorine system plan layout for a 10 MGD water treatment plant.

#### *UV Light*

Ultraviolet (UV) disinfection is a physical disinfection process, as opposed to a chemical disinfection process. It uses electromagnetic energy in the 200 to 300 nanometers (nm) wavelength range to inactivate microorganisms. The inactivation of microorganisms is based on the UV dose ( $\text{mWs/cm}^2$ ), which is a product of the light intensity ( $\text{mWs/cm}^2$ ), and the exposure time (seconds). The UV dose is analogous to the CT term used for inactivation credit for chemical oxidants. Since the UV dose is primarily based on the light intensity, water quality parameters that have the most effect on UV dose are turbidity and suspended solids that can shield microorganisms from the UV light, and some organic and inorganic compounds that can absorb UV light. **Figure 6-6** illustrates a typical UV disinfection unit.

UV disinfection has a major advantage of little or no production of DBPs. Studies have shown that there is no appreciable increase in TTHM or HAA concentrations as a result of UV disinfection at doses that would be applicable in water treatment. UV does not depend upon typical water quality parameters (pH, temperature) as chemical disinfectants. The disadvantages of UV include: (1) little full-scale experience in surface water treatment, (2) does not hold a residual and must be followed by a residual disinfectant for the distribution

system, (3) technology is still evolving.

The SWTR requires that the disinfectant residual of water entering the distribution system be continuously monitored by water systems serving a population of more than 3,300 people. For this project, in order to meet the minimum requirement of free chlorine of less than 0.2 mg/L for no more than four (4) hours, at least 0.5 mg/L of free chlorine residual is required to be added at the high service pump station (HSPS). This requirement, however, contributes a merit of chlorine disinfection system, which confirms the preliminary selection of on-site hypochlorite generation system.

A preliminary cost estimates was developed to compare an on-site hypochlorite system with a UV + on-site hypochlorite combined system, as shown in **Table 6-4**. As shown in the table, the cost of using on-site hypochlorite generator is lower. With consideration of cost and reliability, on-site hypochlorite generation system was recommended for this project. The final selection may vary depending on the actual water quality and TOC removal.

**Table 6-3. Cost Comparison for Chlorine Sources<sup>1</sup>**

Chlorine Source	Capital Cost			O & M Cost		Total <sup>3</sup>
	Civil, Electrical etc.	Chlorine Equipment	Total <sup>2</sup>	Annual	Total	
Commercial Grade Hypochlorite <sup>4</sup>	\$103,000	\$28,000	\$221,000	\$18,000	\$203,000	\$424,000
On-Site Hypochlorite Generation <sup>5</sup>	\$55,000	\$85,000	\$235,000	\$14,000	\$164,000	\$399,000
Gas Chlorine	\$103,000	\$1,135,000	\$2,080,000	\$14,000	\$159,000	\$2,238,000

## Notes:

1. Based on 10-mgd plant capacity and 100-lb of dry chlorine weight per day
2. Adding 40% for construction contingency and 20% for engineering
3. Total cost (present value) equals to total capital cost (present value) + total O & M cost (present value)
4. Commercial grade at 12.5%
5. 100-lb system at 0.8%

**Table 6-4. Cost Comparison for Chlorine and UV Systems<sup>1</sup>**

Chlorine Source	Capital Cost			O & M Cost		Total <sup>3</sup>
	Civil, Electrical etc.	Chlorine Equipment	Total <sup>2</sup>	Annual	Total	
On-Site Hypochlorite Generation <sup>4</sup>	\$55,000	\$85,000	\$235,000	\$14,000	\$164,000	\$399,000
UV + Chlorine feed	\$33,000	\$340,000	\$627,000	\$12,000	\$139,000	\$766,000

## Notes:

1. Based on 10-mgd plant capacity for both systems and 100-lb of dry chlorine weight per day, and dry chlorine weight for chlorine feed system and UV system respectively.
2. Adding 40% for construction contingency and 20% for engineering
3. Total cost (present value) equals to total capital cost (present value) + total O & M cost (present value)
4. 100-lb system at 0.8%

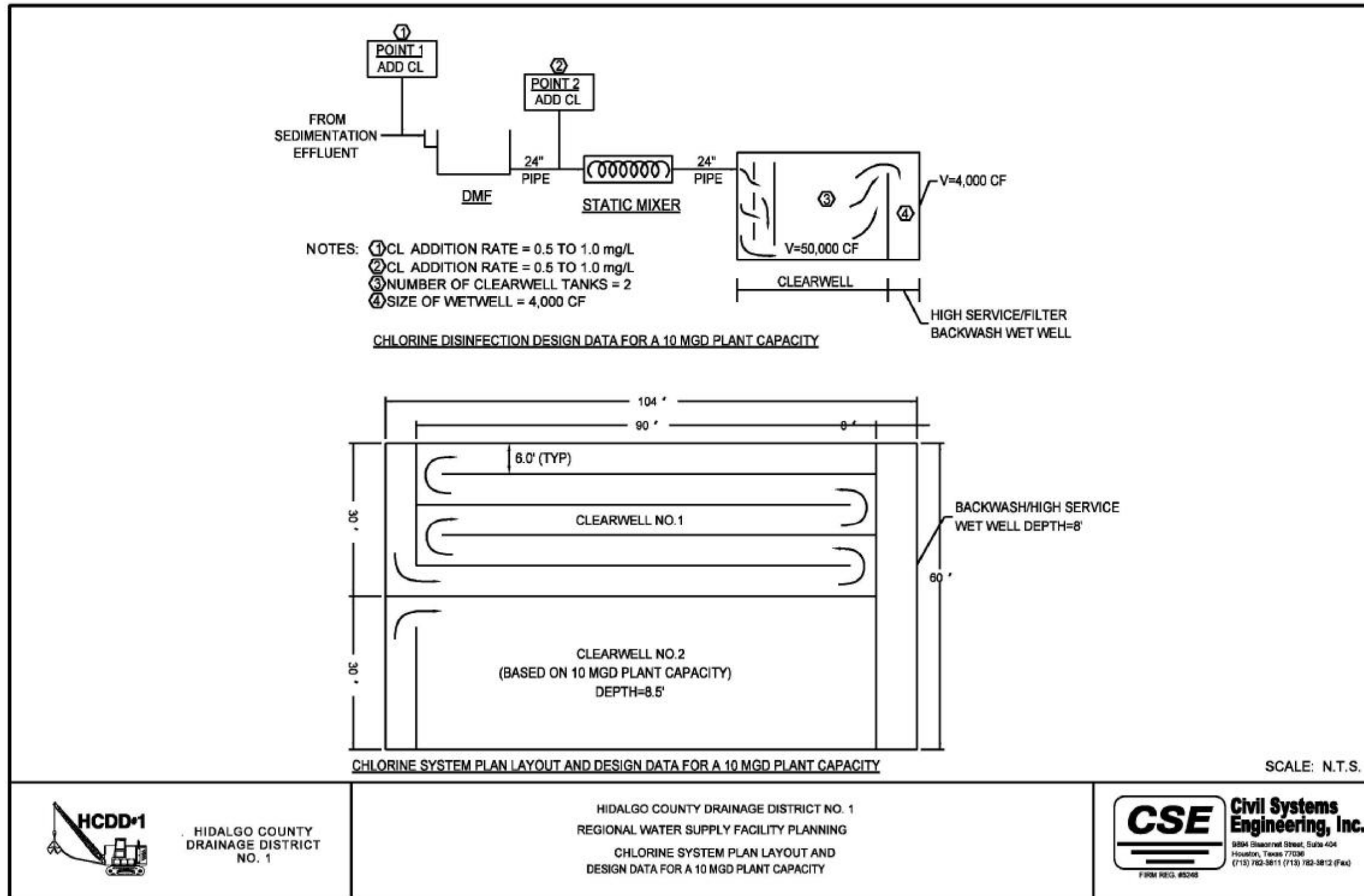
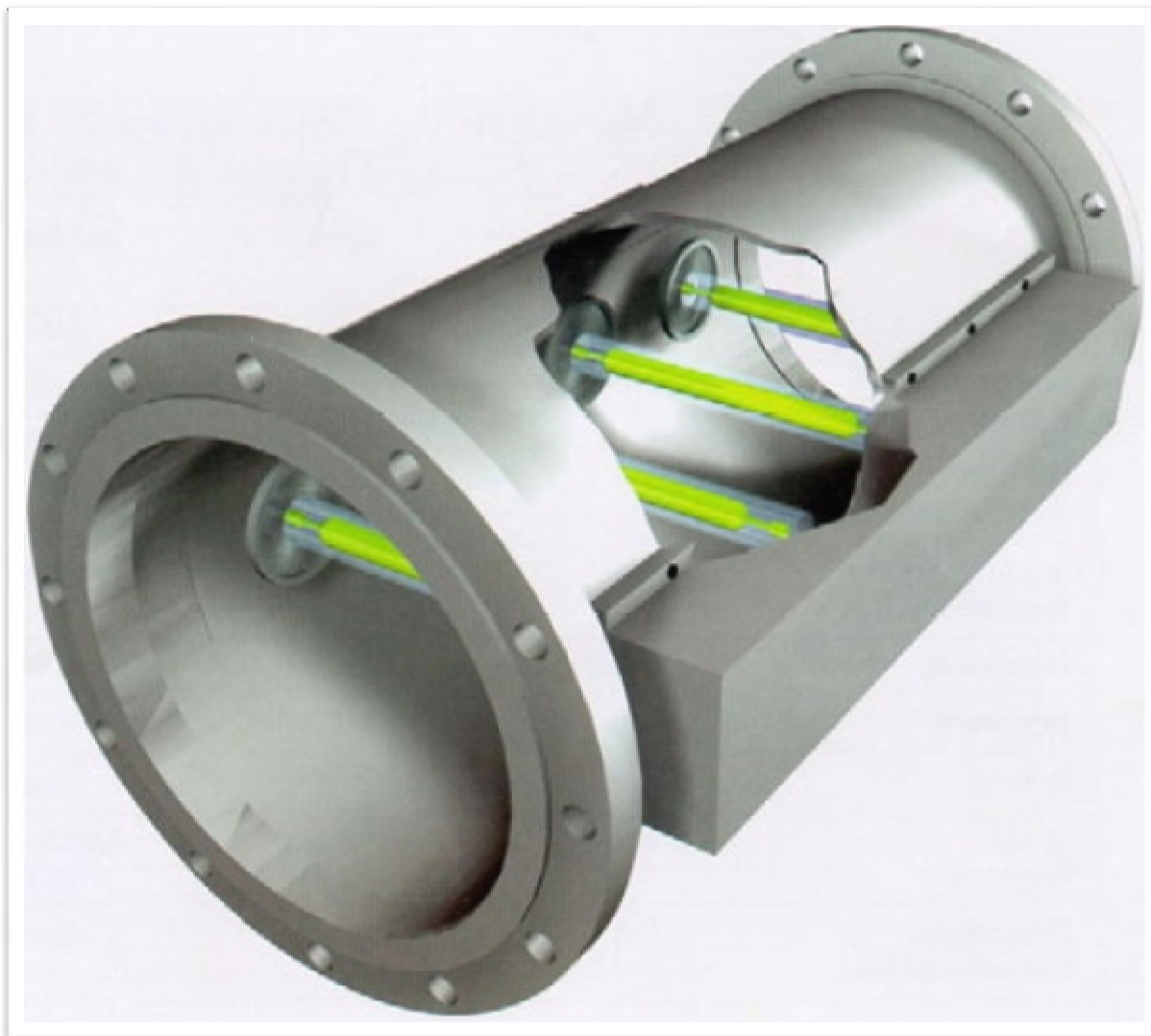

Figure 6-5. Chlorine System Layout



**Figure 6-6. UV Disinfection Unit**

### Softening

Hardness in water is caused by the presence of polyvalent metal ions (cations). Majority of the polyvalent metal ions found in source water are those of calcium and magnesium. Corresponding major anions associated with the calcium and magnesium ions are carbonates ( $\text{Ca}_3^{-2}$ ) and sulfates ( $\text{SO}_4^{-2}$ ).

The untreated water from the drainage ditch for this project has a hardness of approximately 600 mg/L  $\text{CaCO}_3$ . It is considered very hard based on classification by the U.S. Department of Interior and the Water Association (>180 mg/L). Although there are no mandatory removal requirements by both EPA and the current American Water Works Association (AWWA) drinking water standards. Softening is usually employed for waters with hardness greater than 150 mg/L as  $\text{CaCO}_3$ .

Water with high TDS is normally considered hard, because hardness-contributing cations, such as calcium and magnesium, and their counter anions (e.g., carbonate and sulfate) comprise the majority of TDS. The National Secondary Drinking Water Regulations recommend a value of 500 mg/L for TDS in finished water. The untreated water from the ditch has a TDS level of 2,000 mg/L.

Water softening process is required. Water softening is a process used to remove the minerals in the water.

Lime softening is the traditional chemical way to remove hardness ions from water. The process is well

understood and relative easy to operate. Although lime is moderately inexpensive, lime and lime-waste solids, which must be recycled or disposed of, could present a safety hazard to operators unless they are properly stored and handled. Also, the lime treatment needs to be followed by other treatments to remove residual particulates, pathogens, and/or organic material.

Membrane filtration process (NF or RO) for softening water has become a viable alternative. In addition to their ability to remove ions that contribute to hardness, high-pressure membranes are capable of removing other contaminants and microorganisms (e.g. Giardia and Cryptosporidium) as well. With consideration of the raw water quality conditions, softening

### Residuals Management

Residuals management includes managing the wide variety of waste produces generated from the treatment of drinking water using screening, pre-sedimentation, coagulation/flocculation, sedimentation, filtration, disinfection, and softening processes. These residuals may be organic and inorganic compounds in liquid, solid, and gaseous forms depending on the source of raw water and the type of treatment processes.

### *Sedimentation Sludge*

Aluminum and iron coagulants generate inorganic sludge containing compounds such as clay, silts, and organic and inorganic matters precipitated by the coagulant. The solids content for the sludge discharged from ACTIFLO unit ranges between 0.1% and 2%.



### *DMF Filter Backwash Waste*

Filter backwash waste typically represents 2% to 5% of the total water processed. The quantity of solids depends on filter efficiency and the amount of solids applied to the filter. The concentration generally varies from 50 to 400 mg/L.

### *Membrane Backwash Waste and Membrane Clean-in-Place (CIP) Waste*

Membrane backwash waste generally represents 95% to 99% of the residual waste generated from the low-pressure membrane waste. CIP waste requires unique handling due to the use of chemical cleaning constituents such as sodium hypochlorite, citric acid, and caustic soda. It is assumed that both wastes can be handled through the dewatering facility, and then be disposed to a landfill. Further investigation is required during the design phase.

### *Membrane Brine Waste*

Membrane brine waste is generated from NF or RO. The quantity of the rejected water is highly dependent on the type of membrane and source water quality.

**Figure 6-7** shows a typical residual handling process layout for a 10 MGD WTP.

### *Dewatering Process Evaluation*

Dewatering process can be typically divided into two groups: natural and mechanical. The natural dewatering process removes water by gravity, or induced drainage. It requires a large

amount of land area with dry climatic conditions.

**Sand Drying Beds** - A sand drying bed is the first choice with consideration of the dry weather condition in Hidalgo County and land availability at the three potential treatment sites.

To ensure easy handling, the sand drying bed and concrete slabs with concrete walls need to be installed. This will allow the operator to use a bobcat to remove the dried sludge and haul it to the landfill easily. The solids contents from the sand drying bed can be as high as 20%.

**Mechanical Dewatering** - There are three types of equipment commonly used in the dewatering process: filter press, belt press, and a centrifuge. All three require power consumption, chemical addition, and odor control. These processes were not recommended for this project.

### *Brine Disposal Issues*

Using membrane separation process (NF or RO), a considerable volume of brine could be generated on a daily basis. It is of particular importance to properly dispose of the large volume of brine.

It is assumed that any brine waste generated by the water treatment plant will be discharged and managed through disposal back to the Hidalgo County drainage systems with the authorization of Hidalgo County Drainage District No. 1.

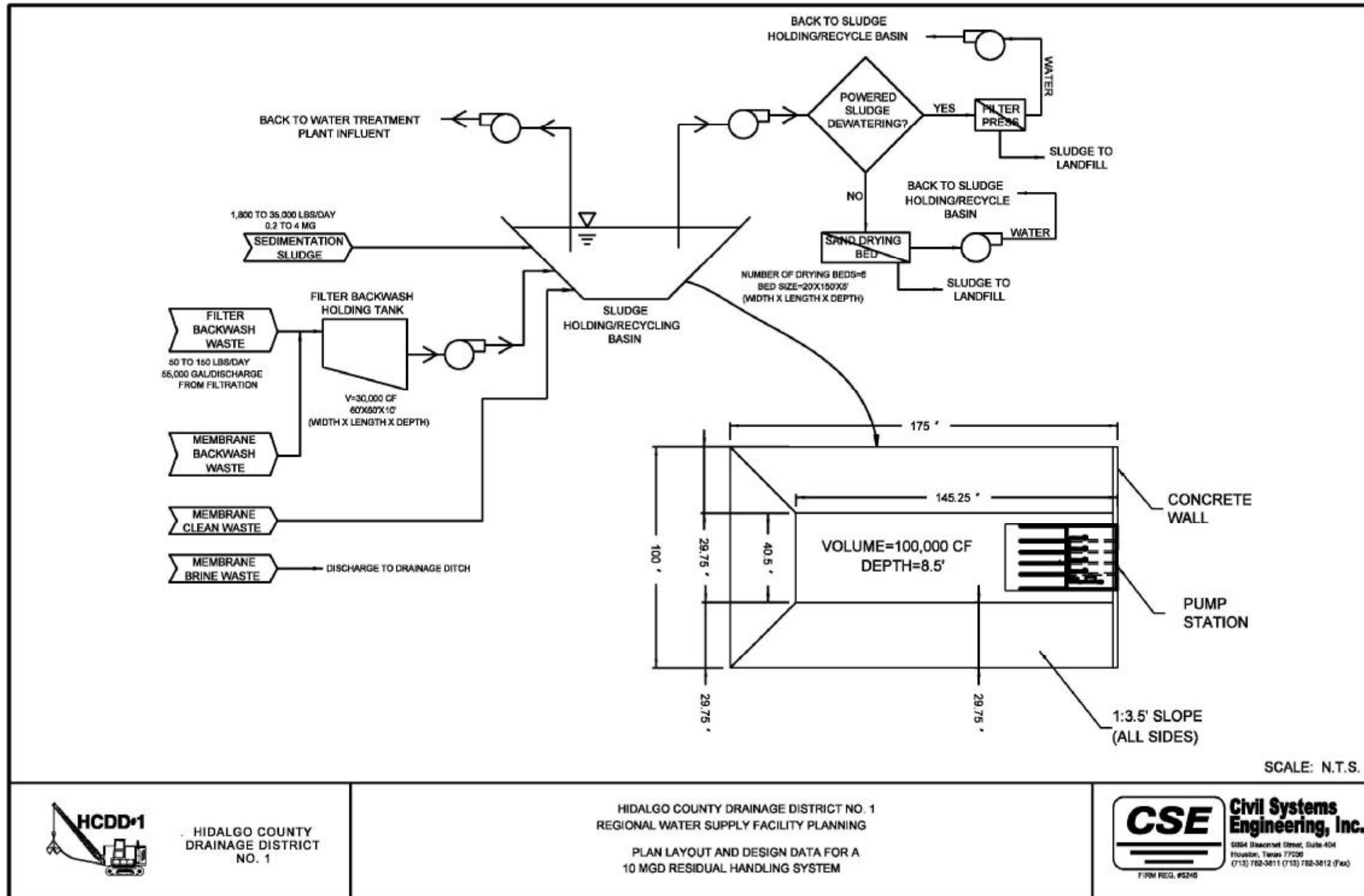

Figure 6-7. Residual Handling Process for a 10 MGD WTP

## Chemicals

Special considerations must be considered in selecting and handling chemicals used for the proposed water treatment process.

The most commonly used coagulant chemicals include:

- § Alum (aluminum sulfate,  $\text{Al}_2(\text{SO}_4)_3 \cdot 14\text{H}_2\text{O}$ ) - the most common coagulant and often used in conjunction with cationic polymers. pH 5.5-7.7 with a typical value of 7.0.
- § Polyaluminum chloride,  $\text{Al}(\text{OH})_x(\text{Cl})_y$  - effective in some cases, requiring less pH adjustment and producing less sludge
- § Ferric chloride,  $\text{FeCl}_3$ , and Ferric sulfate,  $\text{Fe}_2(\text{SO}_4)_3$  - more effective than Alum in some applications. pH 5.0-8.5 with a typical value of 7.5.
- § Cationic polymers can be used alone as the primary coagulant or in conjunction with aluminum or iron coagulants.

Flocculants (Flocculation Aids) are needed to form a floc that is more efficiently removed by settling and filtration. Polymers and other additives can often help for flocculation. Typical additives used in flocculants are:

- § High molecular weight anionic or nonionic polymers
- § Activated silica
- § Bentonite.

Additional chemicals are required based on the turbidity and alkalinity of the

untreated water quality. The selection of the chemicals is based primarily on the following water conditions:

- § High turbidity (> 100 NTU) with high alkalinity (>250 mg/L as  $\text{CaCO}_3$ ): Jar test is required for better coagulation/flocculation operation and optimization.
- § High turbidity with low alkalinity (< 50 mg/L as  $\text{CaCO}_3$ ): The evaluation of cost-effective application of polymers with alum or ferric salts is required through jar test or even bench-scale study.
- § Low turbidity (< 10 NTU) with high alkalinity: Polymers cannot work alone for this condition. Additional particles must be added, usually before the polymer. Clays are a suitable target. Alum and ferric salts are effective in relatively large doses. Clay or activated silica added before the alum can reduce the alum dose, and should produce a more settable and dewaterable floc. Polymers (often anionic) or activated silica added after the alum may produce a more settable floc. This condition does not apply to this project.
- § Low turbidity and low alkalinity: Polymers will not work alone due to the low turbidity condition, and alum or iron salts are usually ineffective, since pH can be below the neutral range. The flocculation rate is too low to permit aggregation if metal polymers are formed to achieve charge neutralization. This condition does not apply to this project.

pH Adjustment Chemicals - Additional chemicals may be required to adjust either the pH or the alkalinity. The

chemicals added are either an acid or a base. In addition, pH adjustment may be required prior to and subsequent to the membrane treatment system. The purpose of pH adjustment is to minimize scaling, to preserve and recover alkalinity, and/or to achieve an optimized pH level for coagulation.

Other chemicals may be needed - filter aid can be selected as for flocculation aid.  $\text{KMnO}_4$  may also be needed due to high concentrations of iron and manganese. Chemical softening can be used to remove calcium and magnesium and would be a cost-effective solution for hardness reduction. The type and amount of chemicals added should be established by the characteristics of the untreated water. Straight Lime-Soda Ash process for this type of water may be required. Straight Lime-Soda ash is typically a single stage softening process by adding lime ( $\text{CaO}$ ) to remove calcium carbonate hardness, and soda ash ( $\text{Na}_2\text{CO}_3$ ) is added to remove noncarbonate calcium hardness. Minor TDS reduction can be achieved since mostly noncarbonate calcium hardness will be ultimately replaced by sodium. The chemical softening process alone cannot remove sodium, potassium and other anions that contribute to the overall TDS level of the raw water.

Storage location, sizing, and feeding points for the chemical feeding system are illustrated in **Figure 6-8** for a 10-mgd WTP.

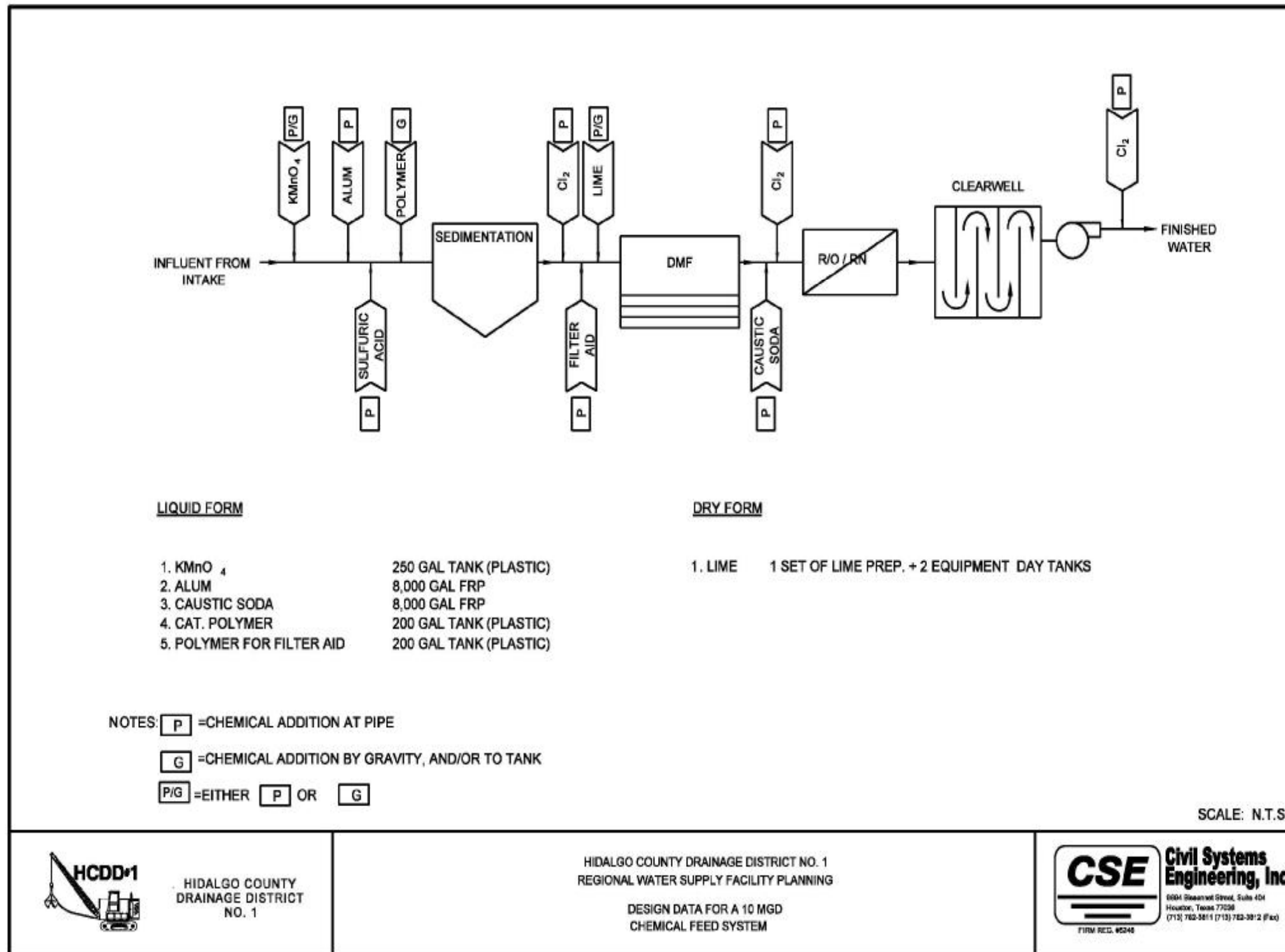

Figure 6-8. Chemical Feed System for a 10 MGD WTP

### Laboratory Operations

Water treatment plant cannot be operated properly without a well-installed lab with clear lab procedures to check and evaluate the quality of water being treated and produced to ensure safe treated water for all water users. Laboratory procedures must comply with the approved methods and meet SWDA monitoring requirements.

To meet the water quality control goals, a set of labware and equipments are required, including glassware (beakers, cylinders, pipets, burets, flasks, funnels, tubers, condensers etc), ovens, hot plates, muffle furnace, clamps, test papers, dissolved oxygen meter, pH meter, turbidimeter, color comparator, spectrophotometer, and chlorine residual test kits.

Other than water quality concerns, proper lab quality test can also provide the necessary data to run the treatment processes more cost-effectively. Minimum jar test equipment is required.

Water supply facilities are responsible for operating the laboratory safely. To prevent laboratory accidents, chemicals should be stored in a properly ventilated and well lit room. All bottles and reagents should be clearly labeled and dated. Volatile liquids which may escape as a gas, such as ether, must be kept away from heat sources, sunlight, and electrical switches. Cylinders of gas in storage should also be capped and secured to prevent rolling or tipping.

**Figure 6-9** illustrates the recommended water sampling locations.

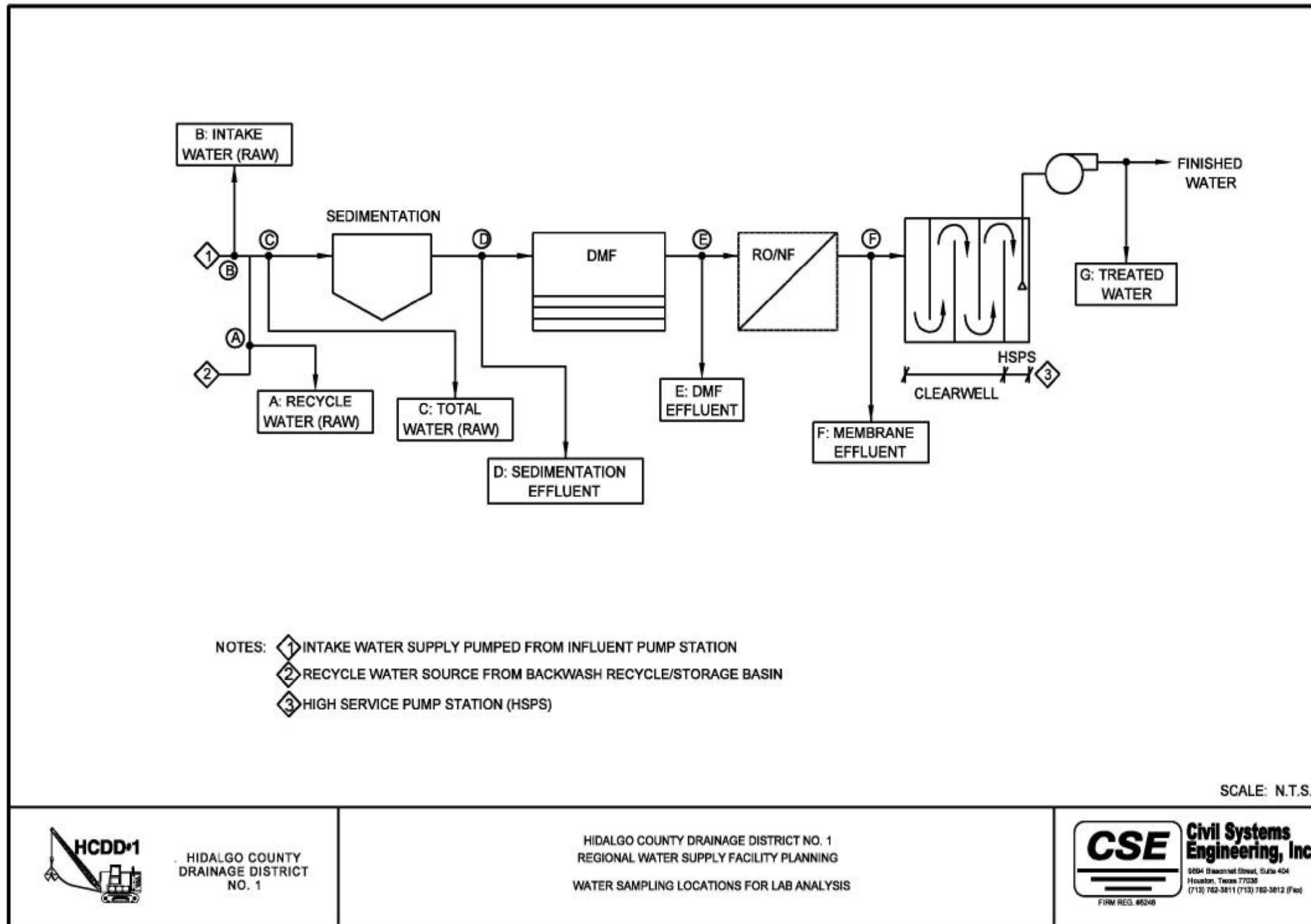

Figure 6-9. WTP Water Sampling Locations

## Alternative Water Treatment Processes

Alternative treatment processes were evaluated based on the raw water quality conditions and finished water quality targets.

As discussed earlier, ACTIFLO is required to remove the suspended solids for this project. DMF can cost-effectively remove contaminants. However, to remove the dissolved solids (TDS) or salinity requires the application of membrane process (RO or NF). A decision making process diagram was developed to assist in the overall unit process evaluation, as shown in **Figure 6-10**. As shown, a combination of ACTIFLO with the filtration treatment processes is necessary. Four (4) alternative water treatment processes were considered and evaluated:

- A. ACTIFLO + DMF
- B. ACTIFLO + NF
- C. ACTIFLO + DMF + NF
- D. ACTIFLO + DMF + RO

The performances of the four alternatives are compared as shown in **Table 6-5**.

Alternative A (ACTIFLO+DMF) - This alternative is able to meet the turbidity requirement. It also remove certain percentage of hardness and TOC. As discussed earlier, ACTIFLO has proven performance to remove turbidity, total organic carbon (TOC), and color. ACTIFLO is able to remove 30-60 percent of TOC from raw water with TOC of 0-500 mg/L. The raw water from the drainage ditch for this project is about 60 mg/L. For raw water with turbidity of 0-2000 NTU, the NTU level

can be reduced to 0.2-2.0 from ACTIFLO and < 0.5 if combined with DMF. This alternative cannot meet the Secondary Drinking Water Standard of 500 mg/L for TDS and cannot remove the high salinity level in the raw water. With considering the conceptual level planning effort of this project and the undecided scheme of how the treated water from this project to be used with the existing water supply systems, this alternative was determined still viable for further consideration.

Alternative B (ACTIFLO+NF) is able to meet the turbidity requirement. It also is able to reduce the hardness level of the raw water from the drainage ditch system. In addition, this system can remove certain percentage of TOC. With consideration of the brackish water quality in the raw water, this alternative cannot remove the salt in the water and probably will not be able to reduce the TDS level below the 1,000 mg/L level. Again, with considering the conceptual level planning effort of this project and the undecided scheme of how the treated water from this project to be used with the existing water supply systems, this alternative was determined still viable for further consideration.

Alternative C (ACTIFLO+DMF+NF) - This alternative is able to meet all finished water requirements as listed in **Table 6-5**. By blending water from DMF and NF processes at a percentage of 30 to 70, a TDS level of 1000 mg/L level can be reached. This alternative is a very promising candidate.

Alternative D (ACTIFLO+DMF+RO) - This alternative is able to meet all finished water requirements as listed in **Table 6-5**. By blending water from



DMF and RO processes at percentage of 50 and 50, a TDS level of 500 mg/L level can be reached. This alternative is also a very promising candidate.

**Figure 6-11** illustrates the schematic of the four alternative treatment processes.

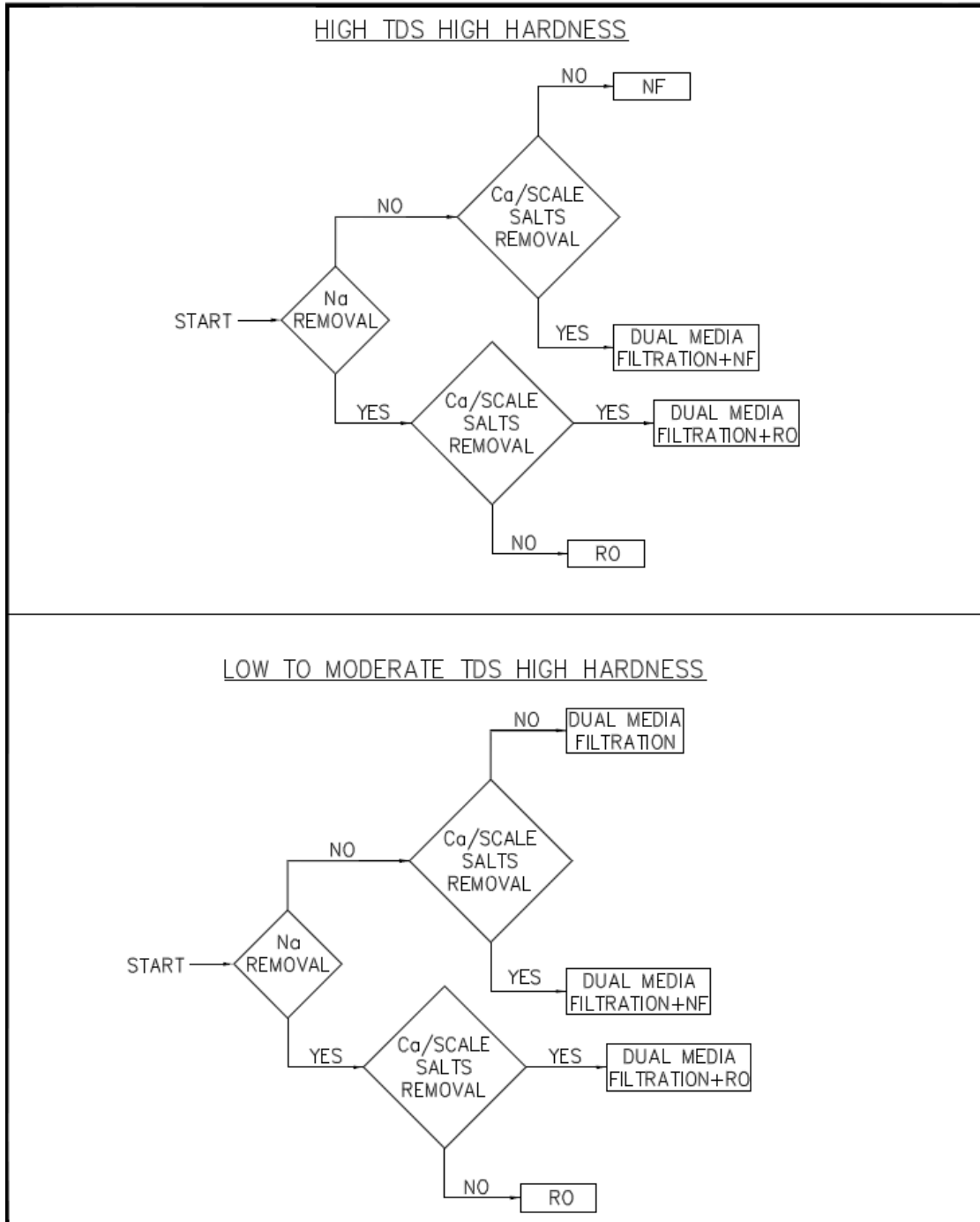

Figure 6-10. Treatment Process Decision Making Process

**Table 6-5. Performance of Alternative Water Treatment Processes**

Alternative	Description	Turbidity (NTU)	Hardness (mg/L as CaCO <sub>3</sub> )	TOC (mg/L)	TDS		Salinity
				% removal	<1000 mg/L	<500 mg/L	
A	ACTIFLO+DMF	ü	ü	ü			
B	ACTIFLO+NF	ü	ü	ü			ü
C	ACTIFLO+DMF+NF	ü	ü	ü	ü		ü
D	ACTIFLO+DMF+RO	ü	ü	ü	ü	ü	ü

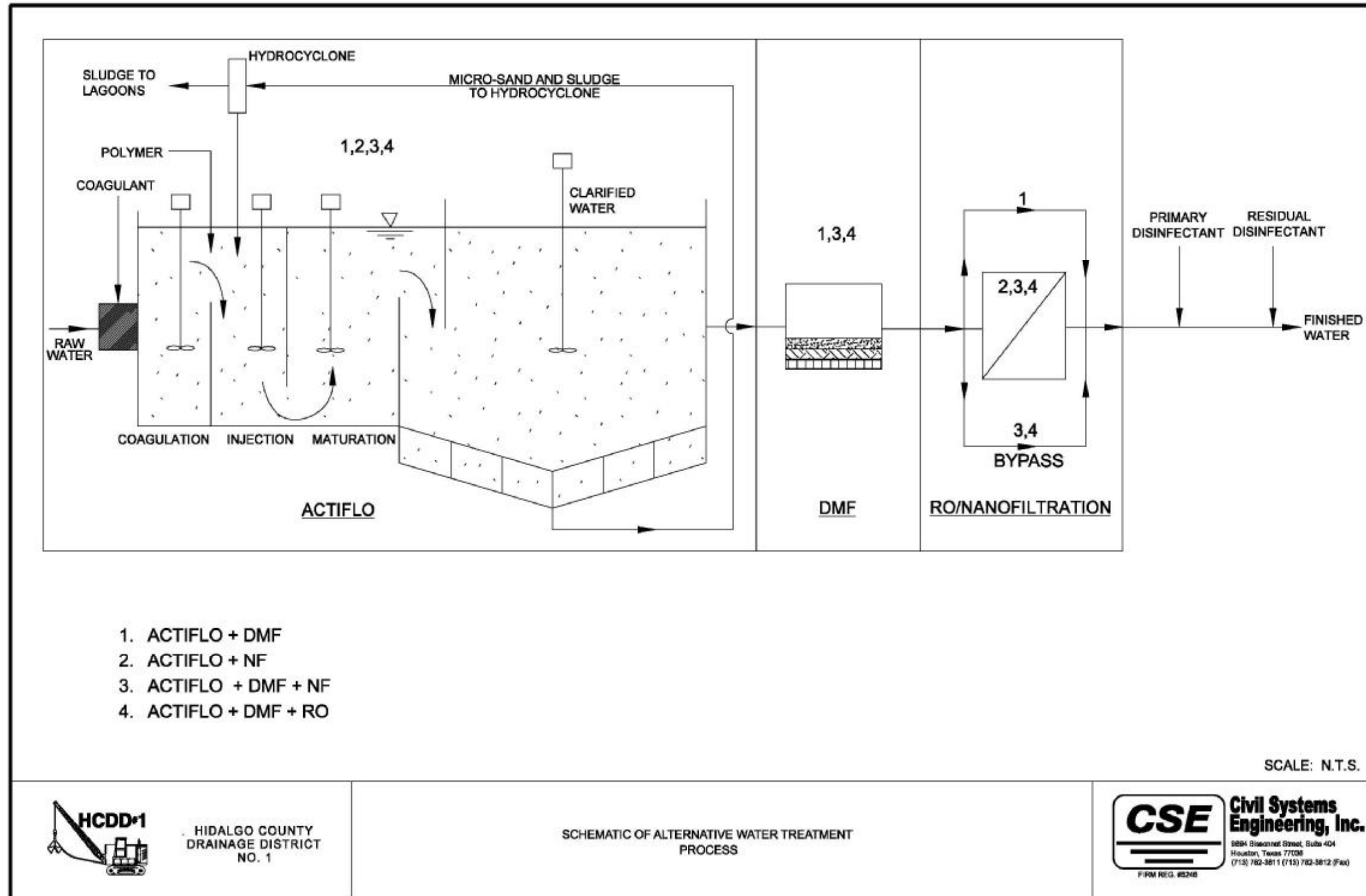

Figure 6-11. Schematic of Alternative Treatment Processes

## 7 Conceptual Designs

Conceptual designs were developed for each of the four (4) alternative treatment processes. The conceptual designs provided the necessary information for cost estimates. Process train was developed for each alternative with conceptual level design data. For each alternative process, four treatment capacities were considered (3MGD, 5MGD, 10MGD, and 13MGD). Also four (4) different building layouts were developed. To minimize initial capital and O&M costs, blending of treated water from DMF and NF is recommended for Alternative C and DMF and RO for Alternative D. The blending rates are governed by the salinity concentrations in the treated water from the DMF process and NF (Alternative C) or RO (Alternative D) process, as well the acceptable levels of TDS established for the public water supplies. In general, the acceptable level of TDS ranges from 500 to 1,000 mg/l. Pilot testing is recommended to determine the most cost effective alternative for this project.

### Alternative A ACTIFLO+DMF

Alternative A is a conventional treatment process with ACTIFLO clarification process followed by DMF (dual media filtration). As discussed earlier, this process could not meet all finished water quality requirements. With consideration of the unknown potential integration with the existing

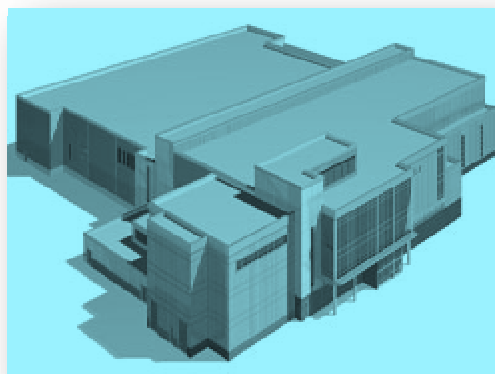

water supply systems, this alternative was still considered as a candidate for the project. Under Alternative A, since there is no membrane process (NF or RO) used, no blending is required. **Figure 7-1** shows the water treatment process flow diagram with conceptual design data for this alternative.

### Alternative B ACTIFLO+NF

Alternative B is a integrated membrane system with ACTIFLO clarification process followed by NF (nanofiltration). As discussed earlier, this process could not meet all finished water quality requirements, especially salinity water quality parameter. Like Alternative A, with consideration of the unknown potential integration with the existing water supply systems, this alternative was still considered as a candidate for the project. Under Alternative B, since there is no membrane process (NF or RO) used, no blending is required. **Figure 7-2** shows the water treatment process flow diagram with conceptual design data for this alternative.

## **Alternative C**

### **ACTIFLO+DMF+NF**

Alternative C is an integrated membrane system with ACTIFLO clarification process followed by DMF ( dual media filtration) and NF (nanofiltration). This alternative process can meet all finished water quality requirements. With consideration of blending treated water from DMF and NF, this alternative is economically feasible and was considered as one of the preferred alternatives. **Figure 7-3** shows the water treatment process flow diagram with conceptual design data for this alternative.

## **Alternative D**

### **ACTIFLO+DMF+RO**

Alternative D is an integrated membrane system with ACTIFLO clarification process followed by DMF ( dual media filtration) and RO (reverse osmosis). This alternative process can meet all finished water quality requirements. With consideration of blending treated water from DMF and NF, this alternative is economically feasible and was considered as one of the preferred alternatives. **Figure 7-4** shows the water treatment process flow diagram with conceptual design data for this alternative.

## **Alternative Building**

### **Layouts**

Four alternative building arrangement layouts were prepared, as shown in **Figures 7-5** through **7-8**.

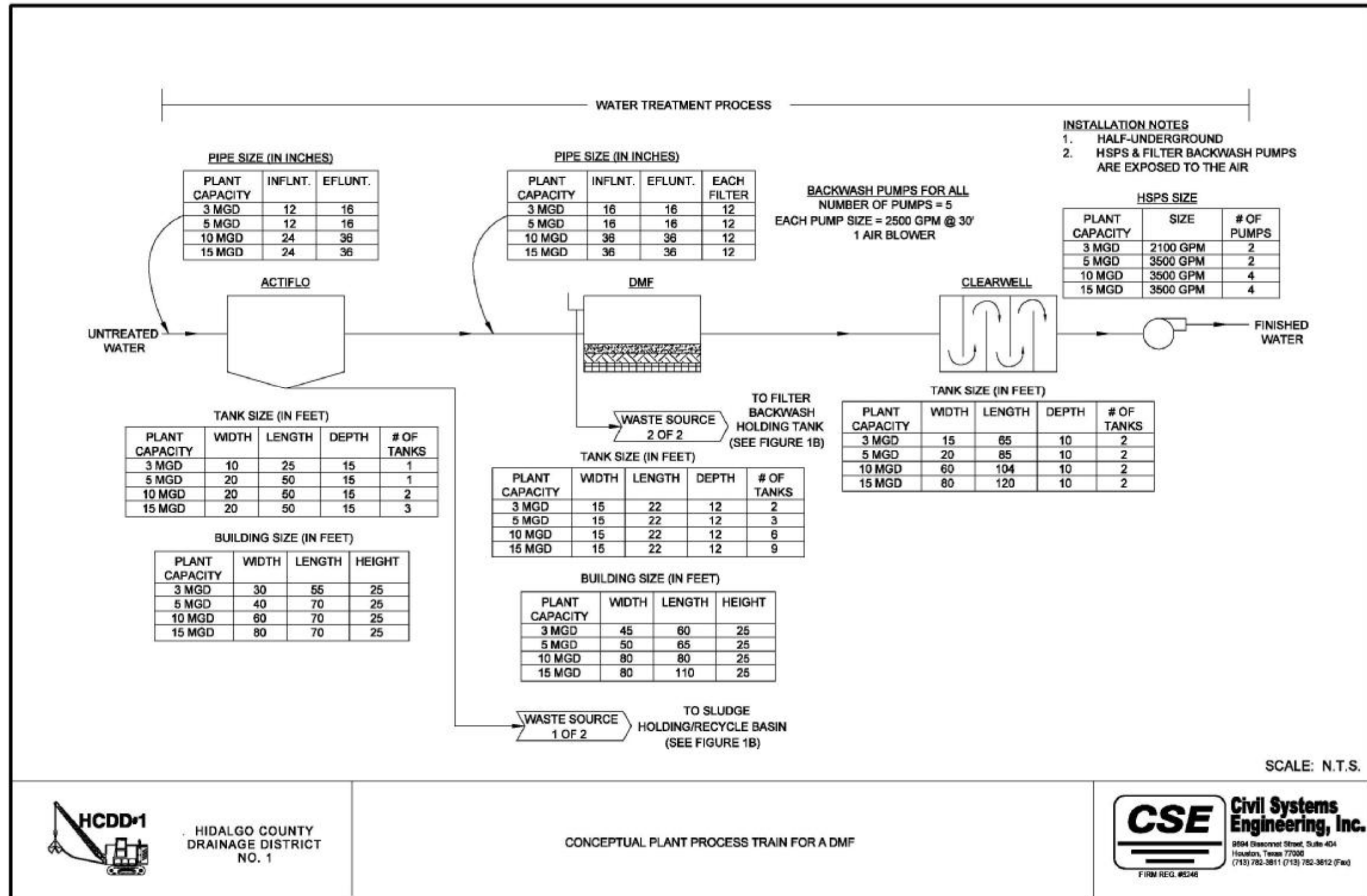

Figure 7-1-1 Conceptual WTP Process Train for Alternative A - ACTIFLO + DMF

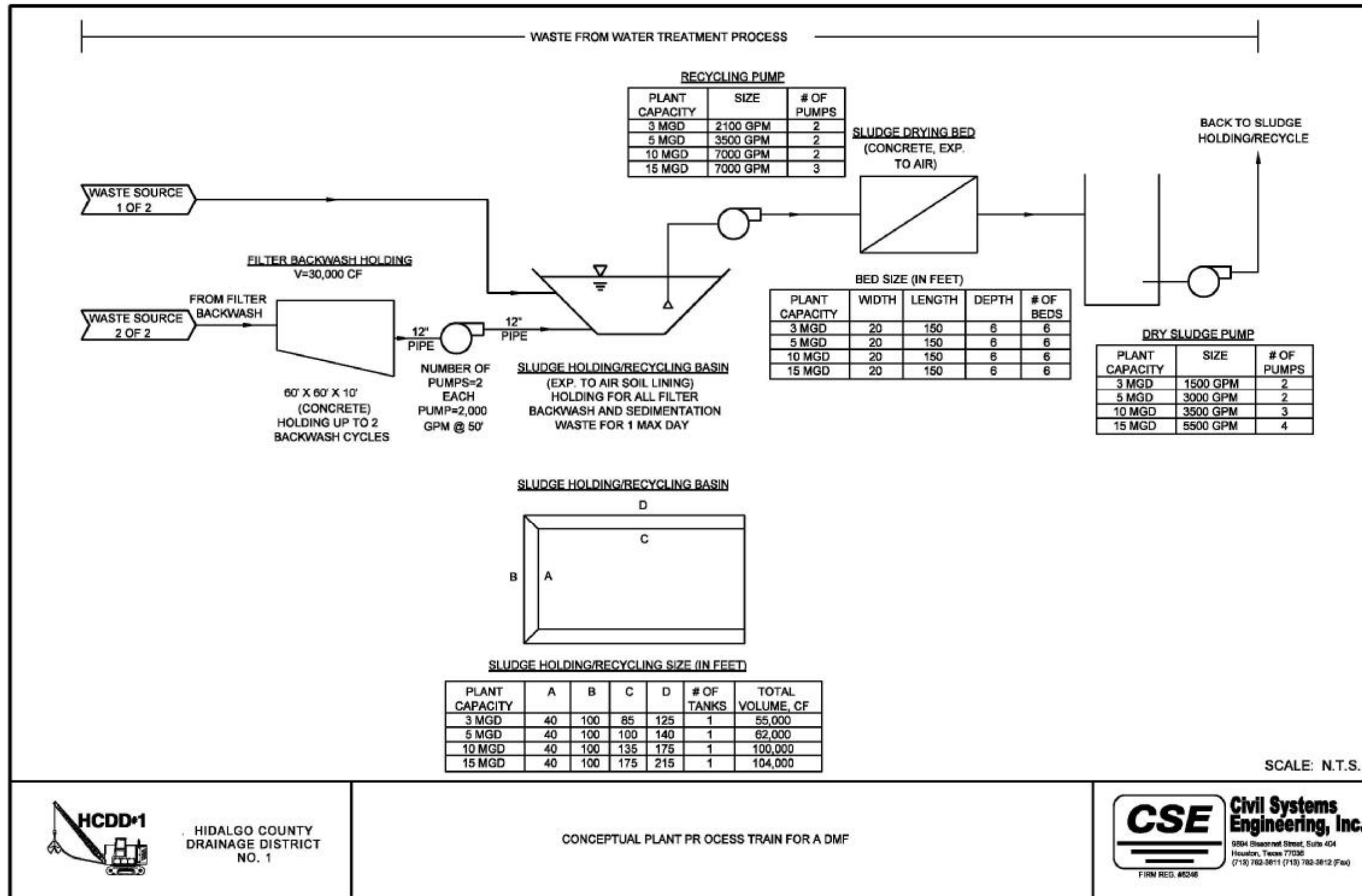
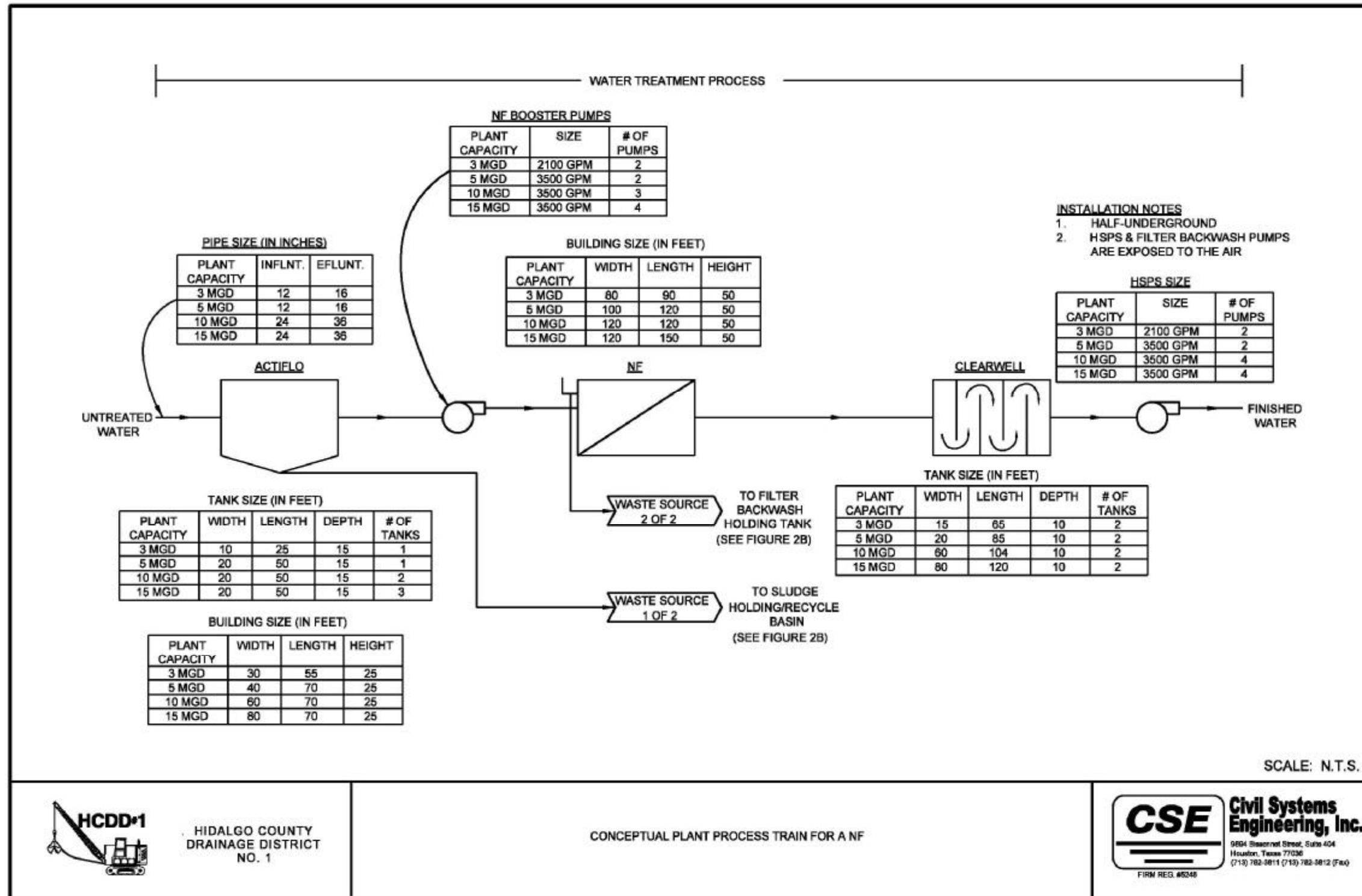

Figure 7-1-2 Conceptual WTP Process Train for Alternative A - ACTIFLO + DMF





HIDALGO COUNTY  
DRAINAGE DISTRICT  
NO. 1

CONCEPTUAL PLANT PROCESS TRAIN FOR A NF



**Civil Systems  
Engineering, Inc.**

9554 Rivercrest Street, Suite 404  
Houston, Texas 77036  
(713) 782-9811 (713) 782-9812 (Fax)

FIRM REG. #6248

Figure 7-2-1 Conceptual WTP Process Train for Alternative B - ACTIFLO + NF

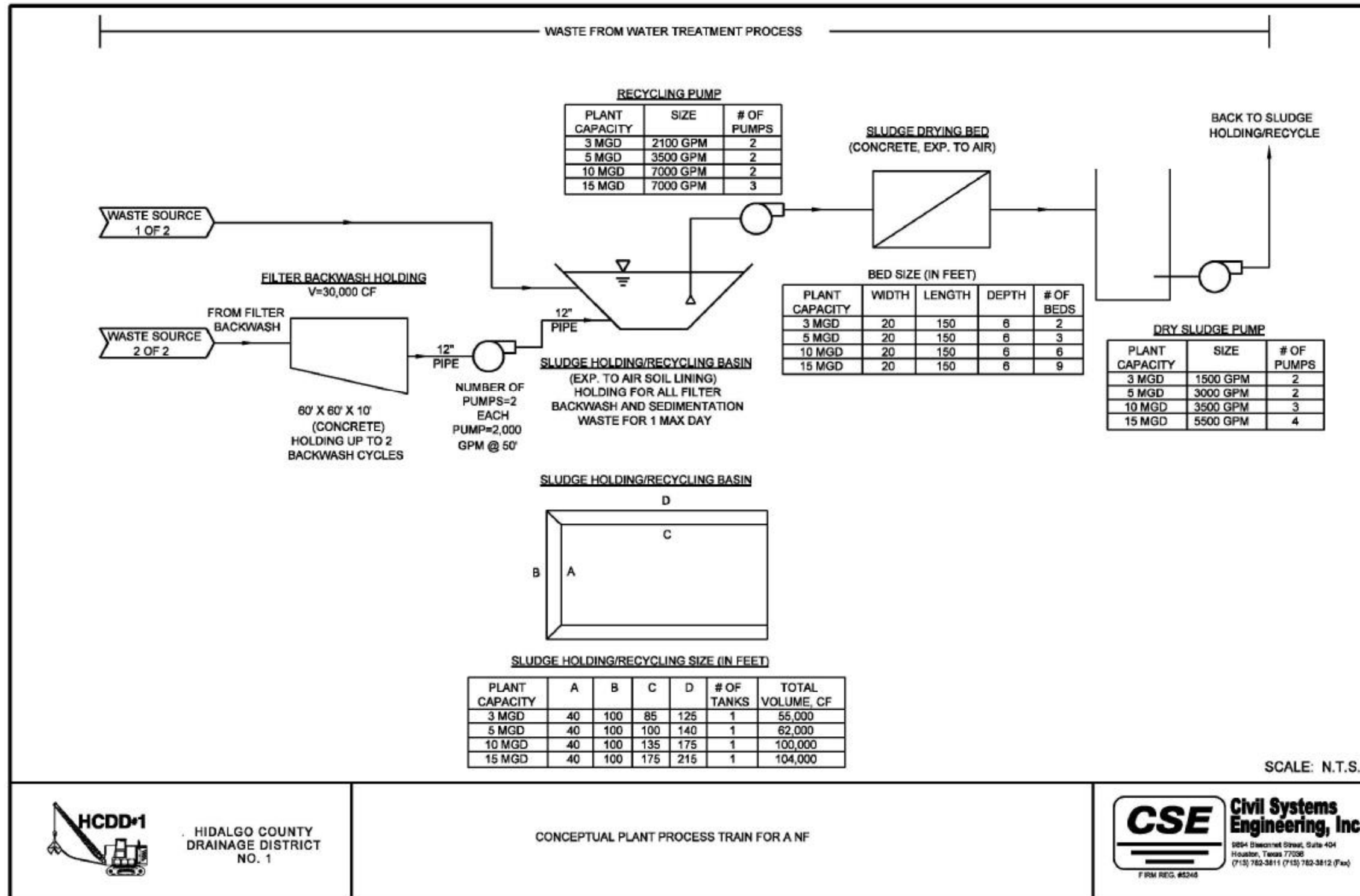

Figure 7-2-2 Conceptual WTP Process Train for Alternative B - ACTIFLO + NF

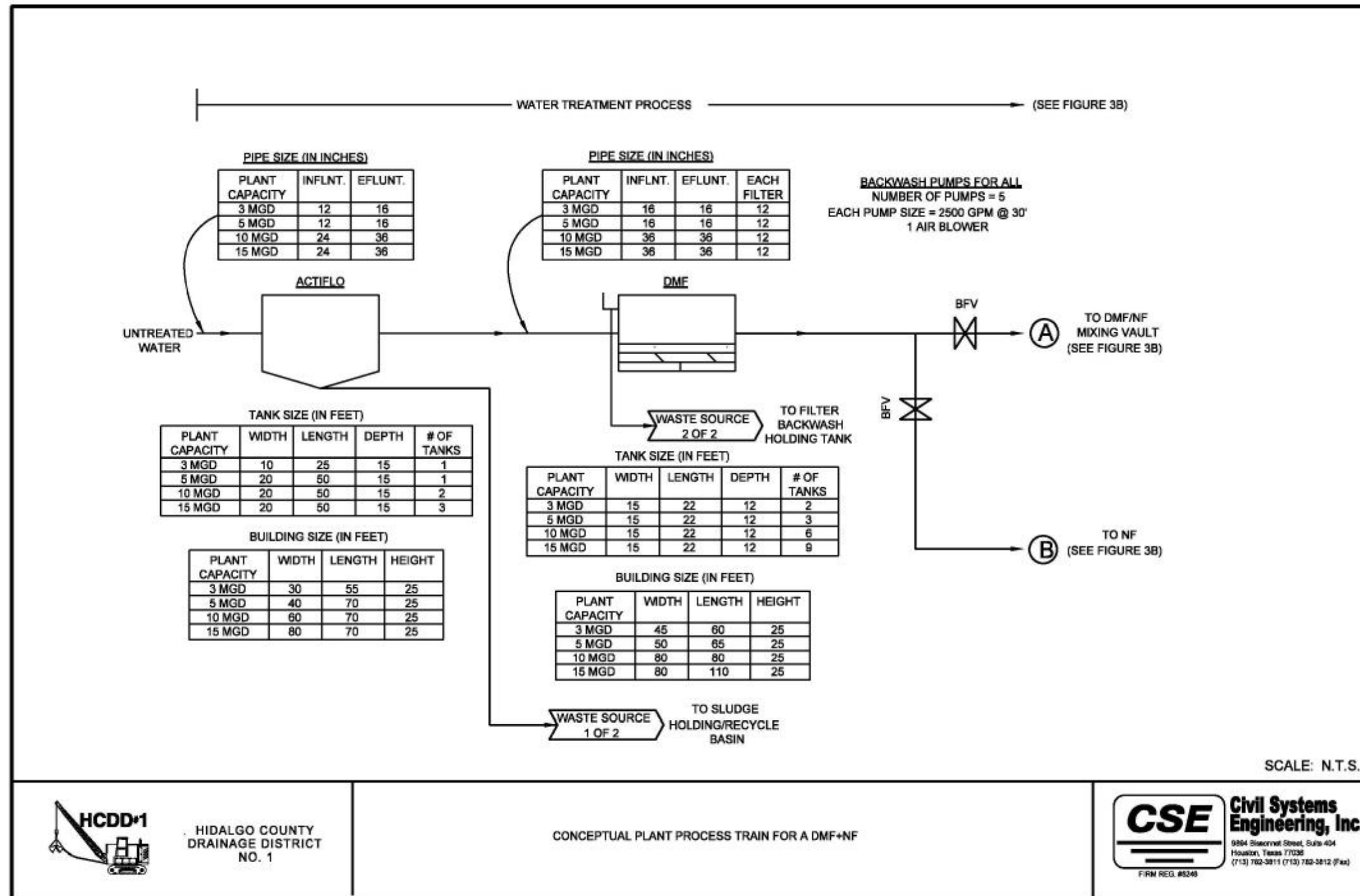

Figure 7-3-1. Conceptual WTP Process Train for Alternative C - ACTIFLO + DMF + NF

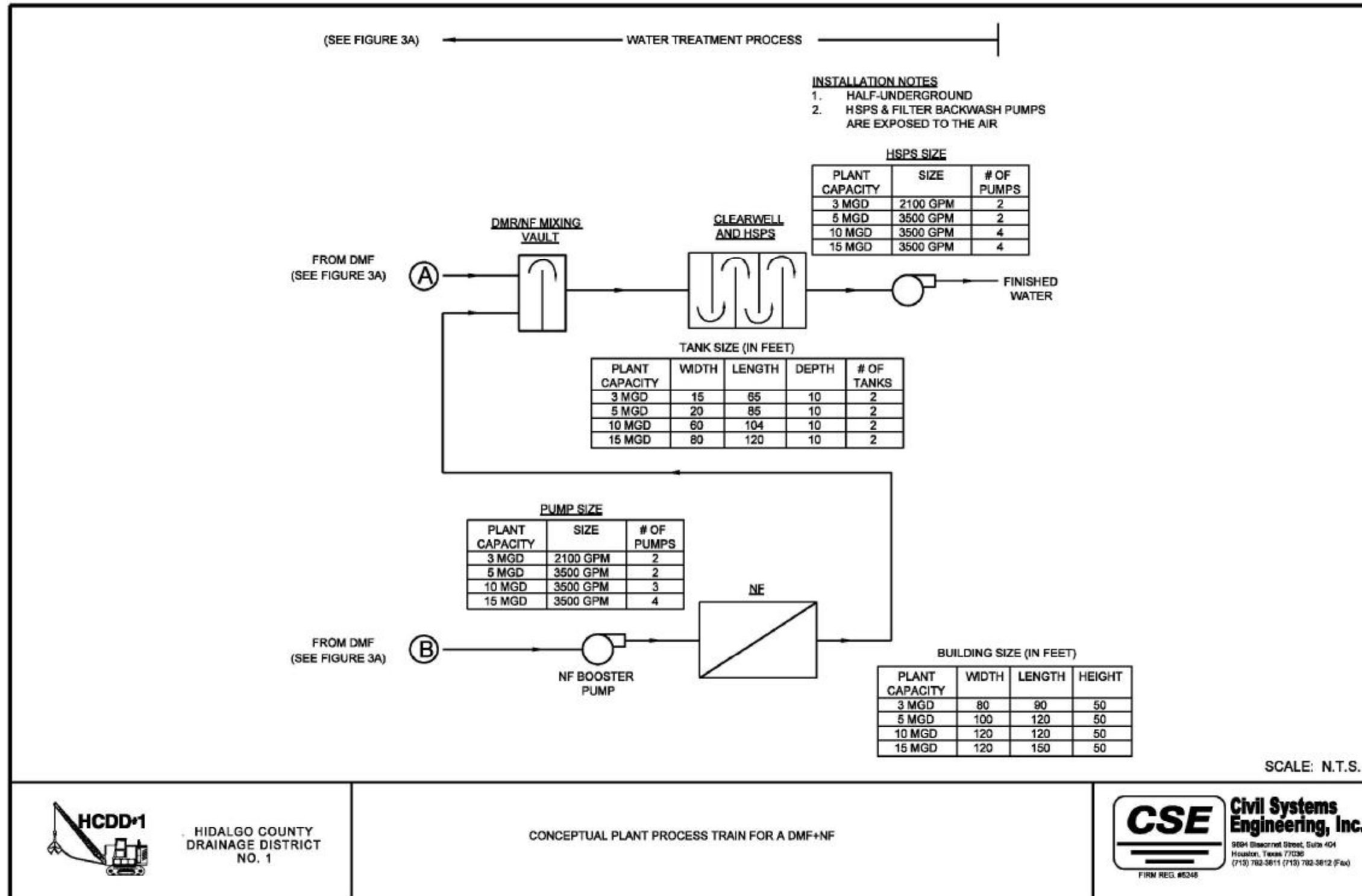
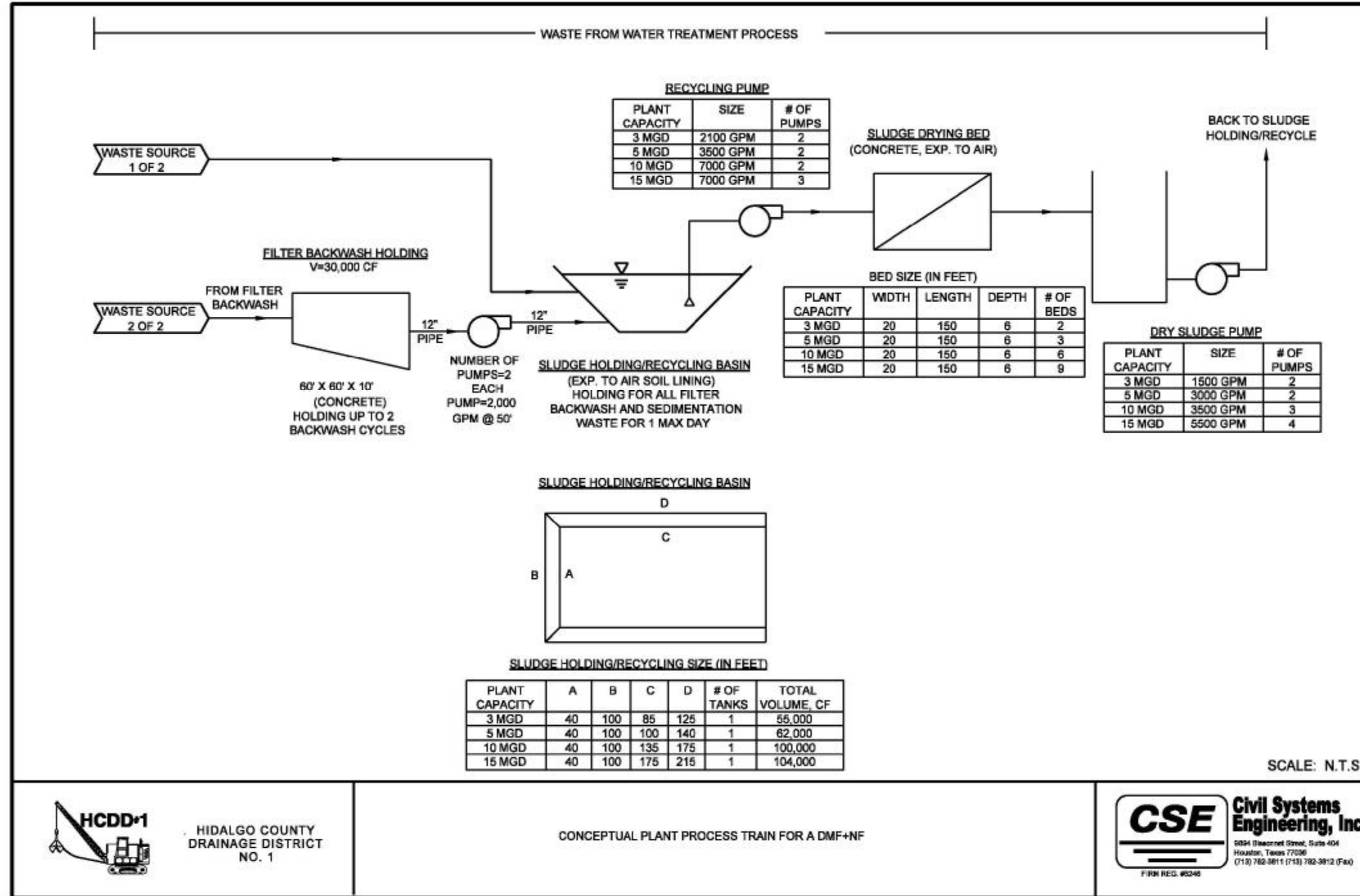

Figure 7-3-2. Conceptual WTP Process Train for Alternative C - ACTIFLO + DMF + NF



HIDALGO COUNTY DRAINAGE DISTRICT NO. 1

CONCEPTUAL PLANT PROCESS TRAIN FOR A DMF+NF



Figure 7-3-3. Conceptual WTP Process Train for Alternative C - ACTIFLO + DMF + NF

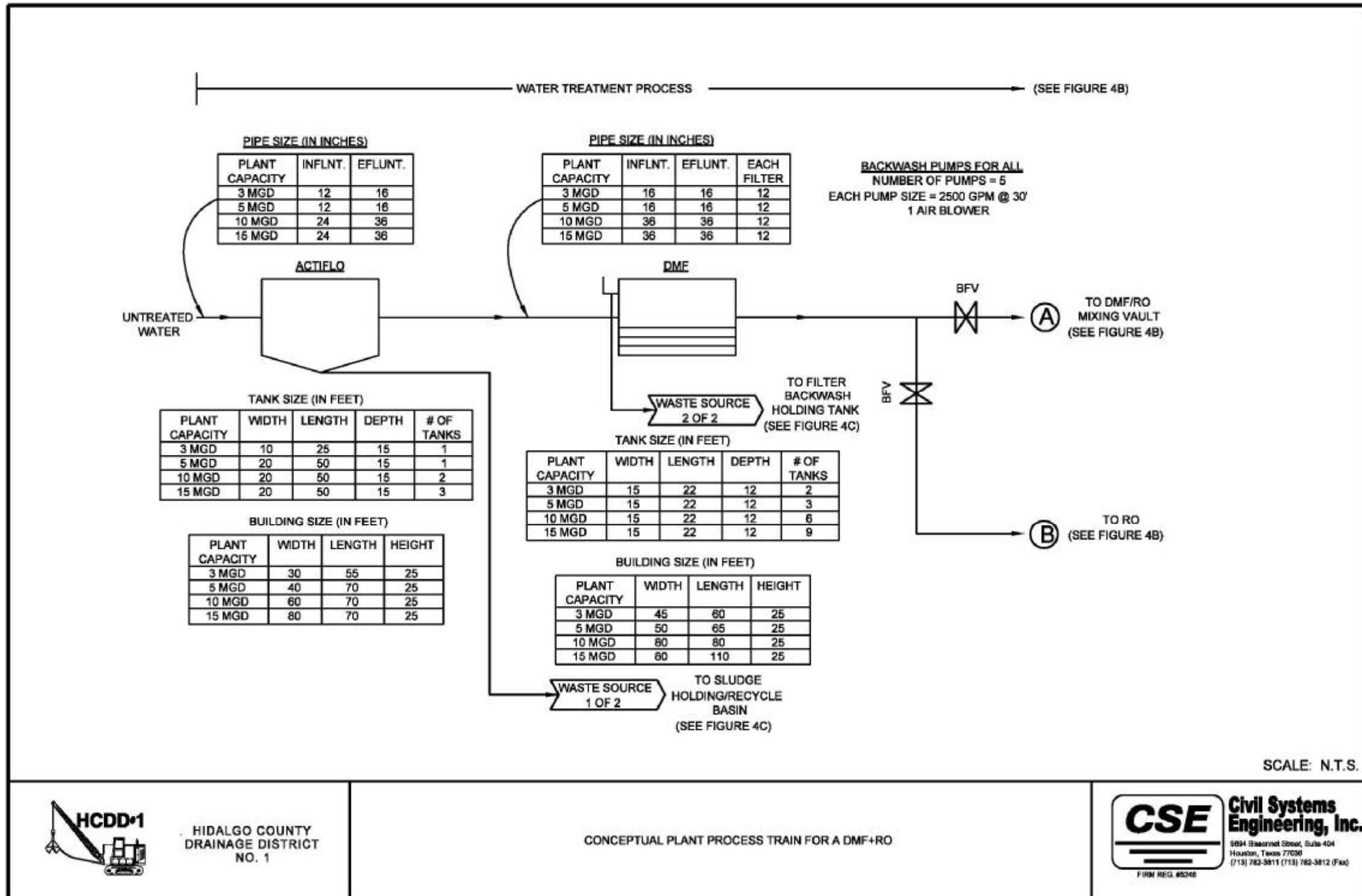

Figure 7-4-1 Conceptual WTP Process Train for Alternative D - ACTIFLO + DMF + RO

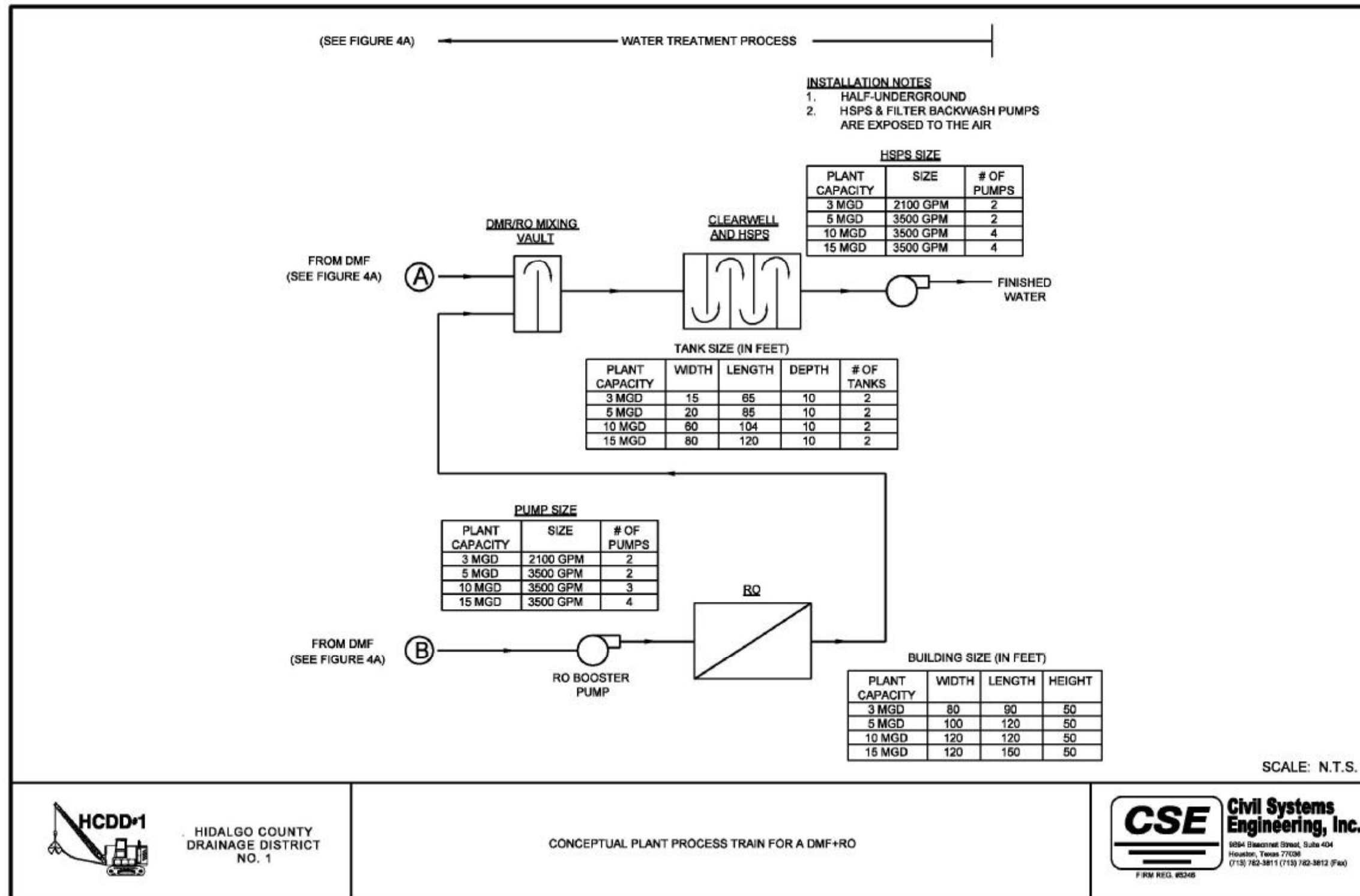

Figure 7-4-2. Conceptual WTP Process Train for Alternative D - ACTIFLO + DMF + RO

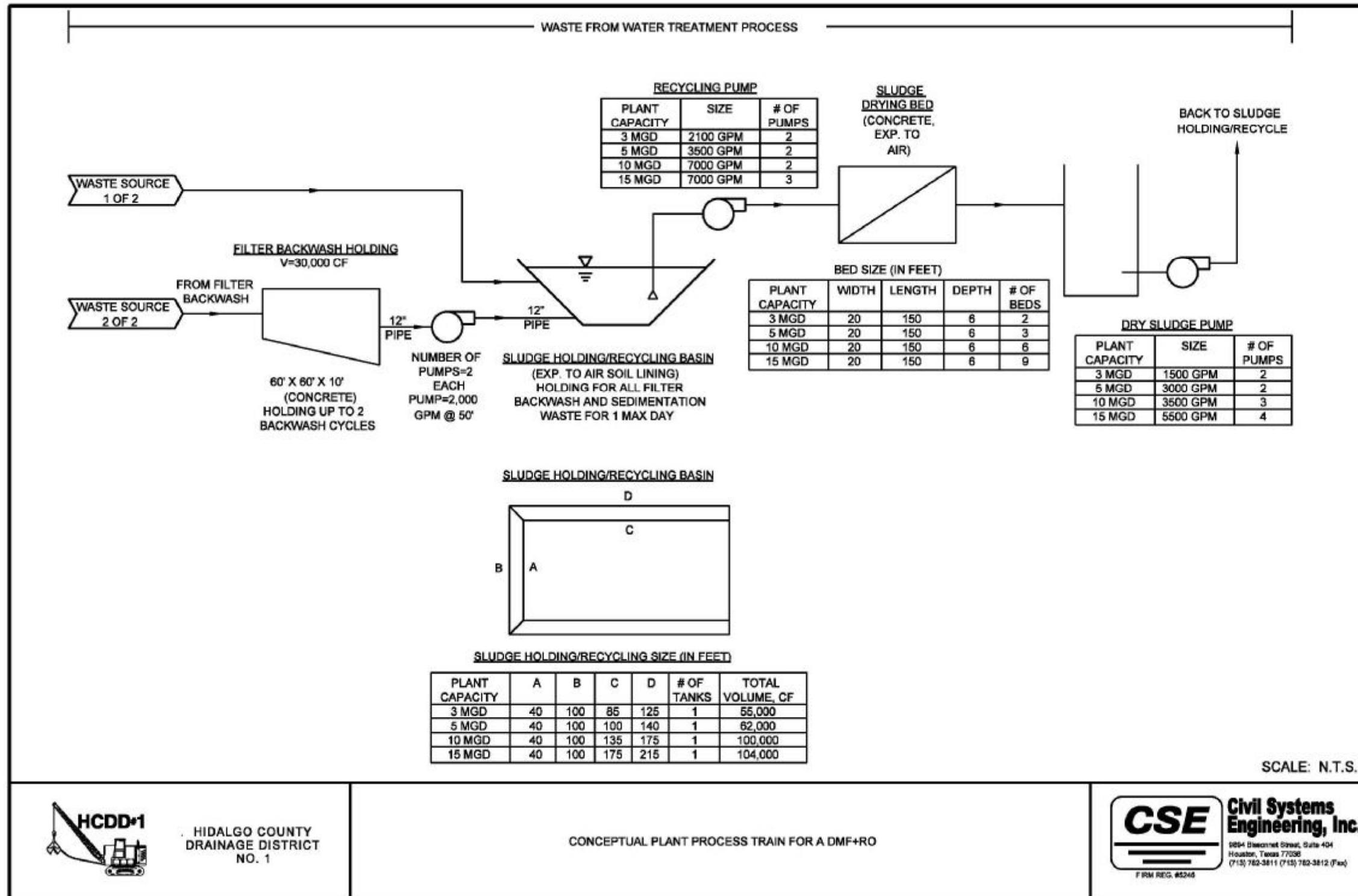

Figure 7-4-3. Conceptual WTP Process Train for Alternative D - ACTIFLO + DMF + RO



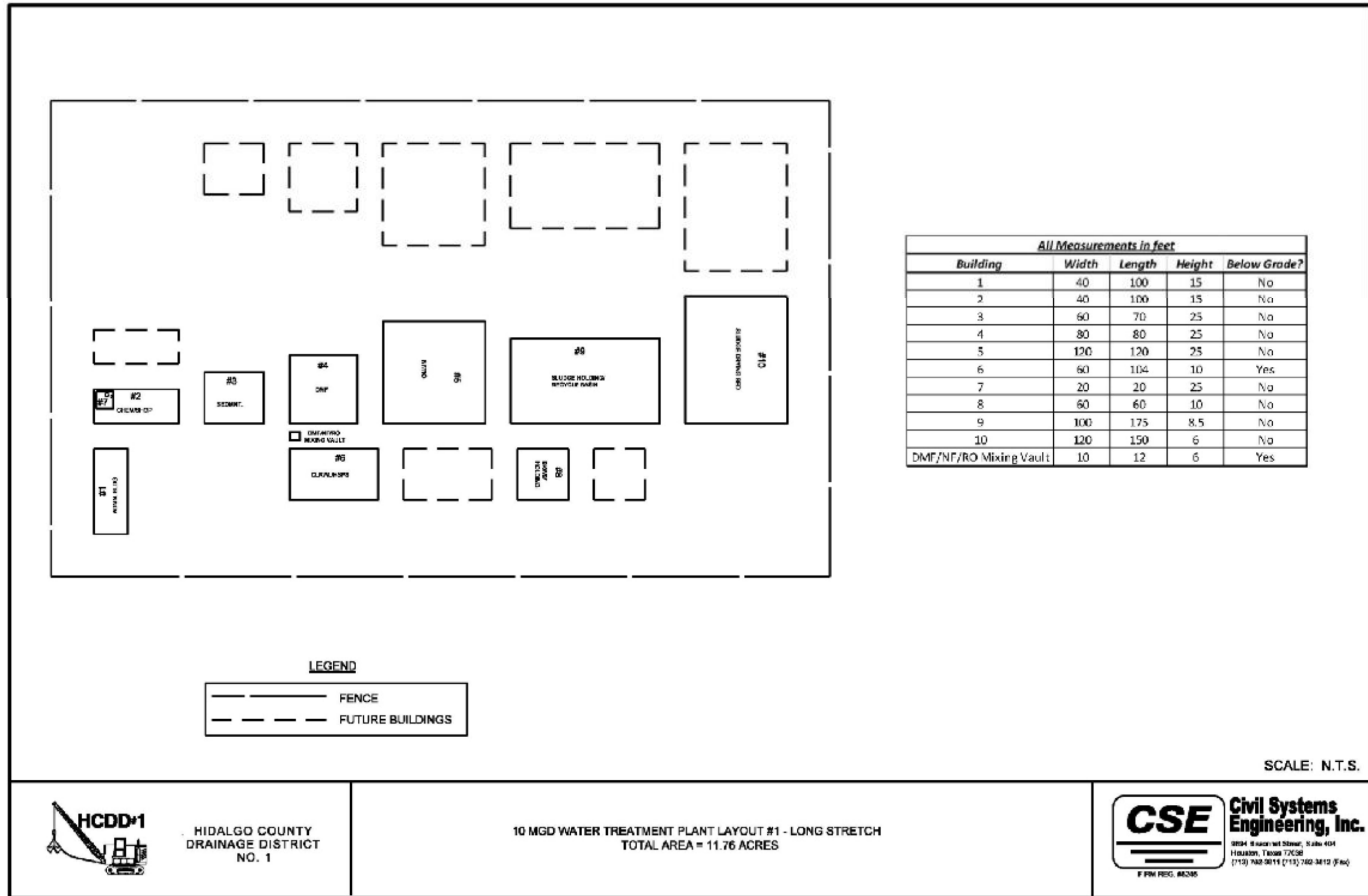

Figure 7-5. Water Treatment Plant Layout - Long Stretch

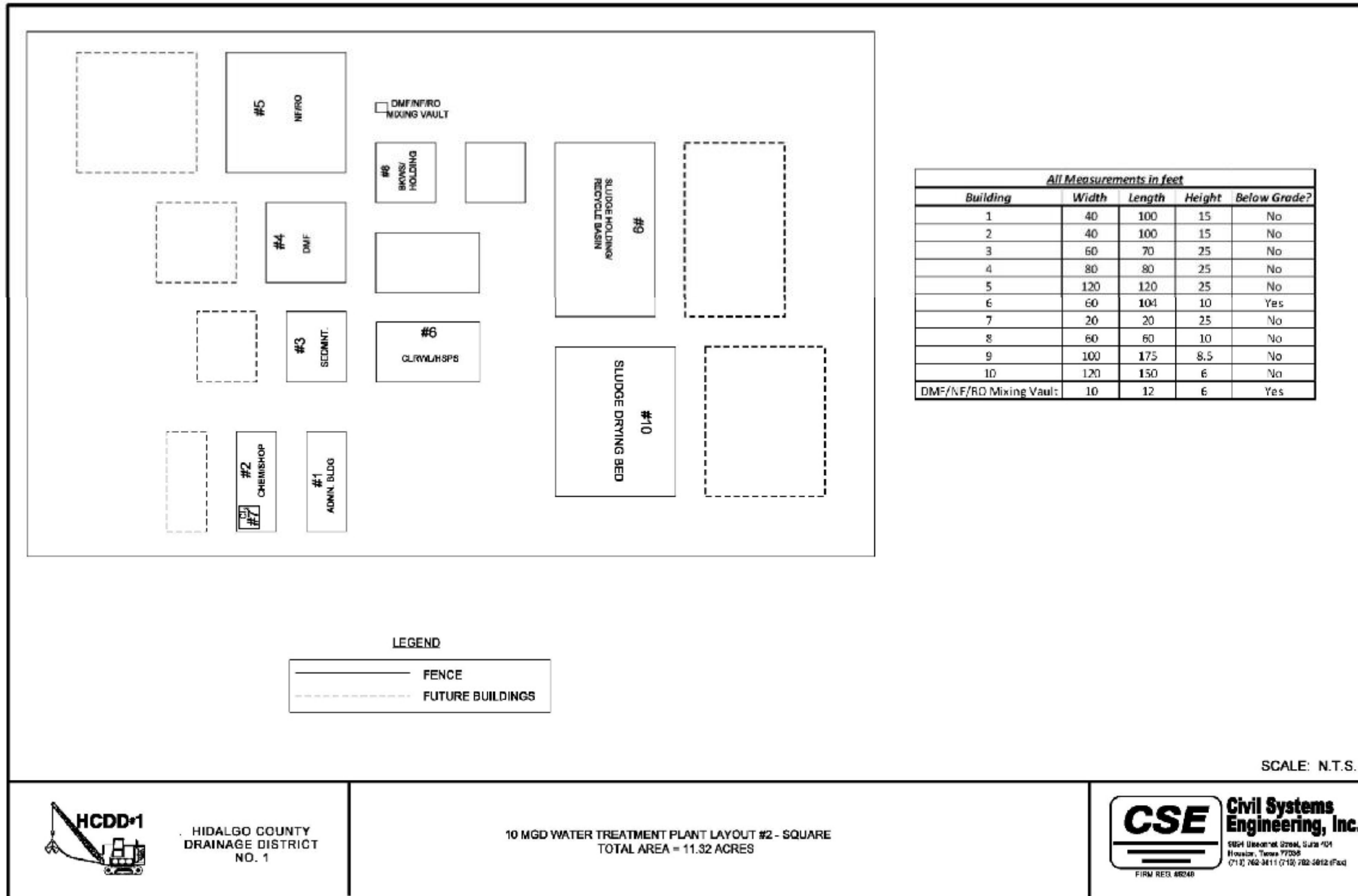

Figure 7-6. Water Treatment Plant Layout - Square

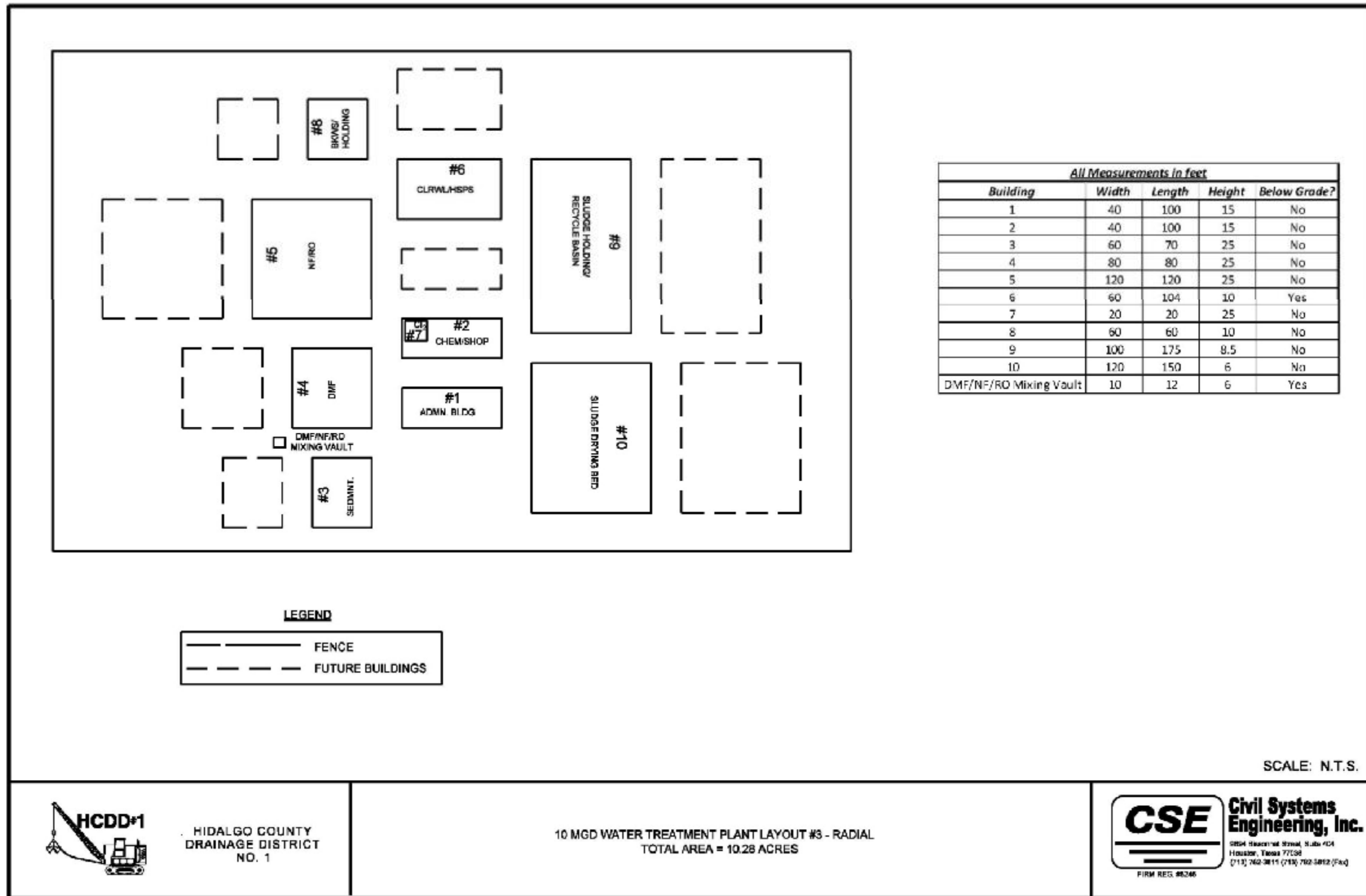
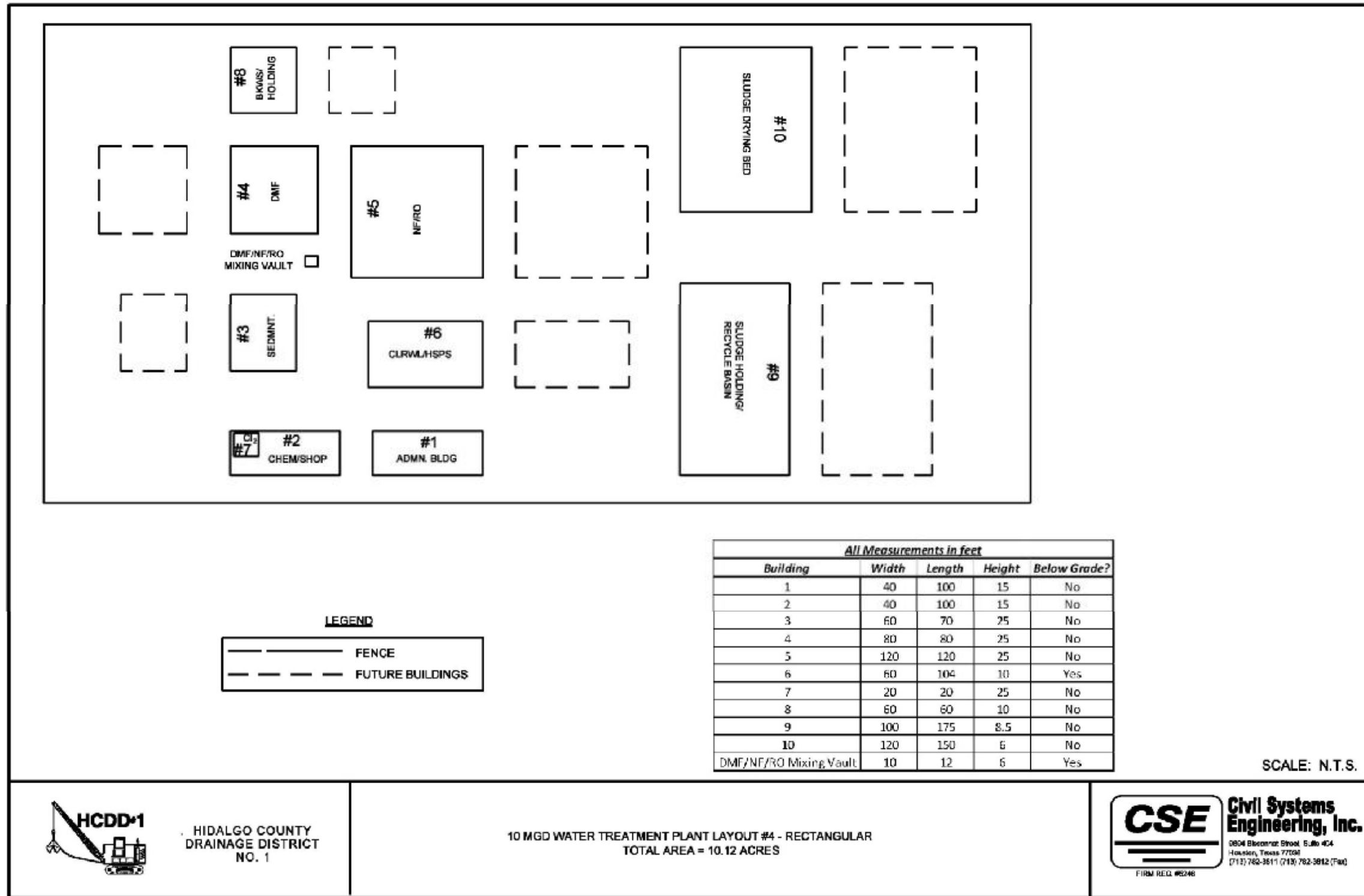

Figure 7-7. Water Treatment Plant Layout - Radial



HIDALGO COUNTY  
 DRAINAGE DISTRICT  
 NO. 1

10 MGD WATER TREATMENT PLANT LAYOUT #4 - RECTANGULAR  
 TOTAL AREA = 10.12 ACRES



**Civil Systems  
 Engineering, Inc.**

9804 Blumensat Street, Suite 424  
 Houston, Texas 77054  
 (713) 762-3611 (713) 762-3812 (Fax)

FIRM REG. #6246

Figure 7-8. Water Treatment Plant Layout - Rectangular



estimate do not include costs for land and rights-of-way. Also intake structures, raw water storage basin, and floodwater detention basin, and transfer pump stations were not included.

Annual O&M cost estimates included all labor and materials required to run the treatment plant.

Cost comparison analysis for this study was performed based on annual costs. The annualized capital cost and annual O&M cost were summed to obtain the total annualized cost for each alternative and treatment capacity. An interest rate of 6% was assumed for the analysis. Life cycle or present value analysis was not performed for the purpose of this study. Costs are presented in 2010 dollars.

It should be noted that the cost estimates for this study are based on conceptual designs. Detailed cost estimates are required for final engineering design. The final cost estimates for the project will depend on actual labor and material costs, competitive market conditions, actual site conditions, final project scope, implementation schedule, continuity of personal and engineering, and other variable factors. The final project costs will likely vary from the estimate presented.

### Itemized Cost Estimates

The itemized cost estimates for each alternative, including capital and annual O&M costs, were developed and are summarized in **Tables 8-1** through **8-12**. As shown in each table, four treatment capacities were considered. **Tables 5** and **6** show itemized capital and O&M costs for Alternative C assuming there is

no blending of treated water from DMF and NF. **Tables 7** and **8** show itemized capital and O&M costs for Alternative D assuming there is no blending of treated water from DMF and RO. **Tables 9** and **10** show itemized capital and O&M cost for Alternative C under the assumption of blending of treated water from DMF and NF at a ratio of 30 to 70 percent. **Tables 11** and **12** show itemized capital and O&M costs for Alternative D under the assumption of blending treated water from DMF and RO at a ratio of 50 to 50 percent.

Total capital costs and annual O&M costs are compared in **Tables 13 and 14**, respectively, under no blending scenario for Alternatives C and D. Total capital costs and annual O&M costs are compared in **Tables 15 and 16**, respectively, under blending scenario for Alternatives C and D.

### Annual Costs

Total annual costs, including annualized capital cost and annual O&M costs, were developed and are compared in **Table 17** under no blending scenario, and **Table 18** under blending scenario.

The unit cost for each alternative per unit of treated water (\$/1000 gallon) was also developed and compared in **Tables 19 and 20** respectively for no blending scenario and blending scenario.

Detailed cost estimates are included in **Appendix D** (attached CD-ROM).

### Potential Funding Sources

The federal government has numbers of programs that support the construction and maintenance of drinking water

systems. The largest program, the Drinking Water State Revolving Loan Fund (DWSRF) was created by the 1996 amendments of the SDWA. This program provides federal grants from EPA to states. The states, in return, loan money to drinking water systems to install, improve, or maintain treatment facilities.

The Texas Water Development Board (TWDB), the state agency, administers the Drinking Water State Revolving Fund (DWSRF). Through the DWSRF, the TWDB will make low-interest loans for financing public drinking water systems that facilitate compliance with primary and secondary drinking water regulations or otherwise significantly further the health protection objectives of the federal Safe Drinking Water Act (SDWA), as amended in 1996. Loans from the DWSRF finance all costs associated with the planning, design and construction of projects to upgrade or replace water supply infrastructure, to correct exceedances of SDWA health standards, to consolidate water supplies and to purchase capacity in water system.

Funding for drinking water systems is also available through the U.S. Department of Housing and Urban Development's Community Development Block Grants, bonds, and the Rural Utility Service of the U.S. Department of Agriculture that provides funds for rural drinking water and waste water systems.

TWDB currently has various financial assistance programs that could provide funding to implement this project. TWDB's financial assistance programs are funded through state-backed bonds, a

combination of state bond proceeds and federal grant funds, or limited appropriated funds. Since 1957, the Legislature and voters approved constitutional amendments authorizing the TWDB to issue up to \$2.68 billion in Texas Water Development Bonds. To date, the TWDB has sold nearly \$1.55 billion of these bonds to finance the construction of water- and wastewater-related projects.

For any funding to be available from the TWDB, the proposed project will need to be added as a viable water management strategy in the "2011 Adopted Region M Regional Water Plan" or will require support from the Region M Regional Water Planning Group for a consistency waiver.

**Table 8-1 Estimate of Probable Capital Costs - Alternative A - ACTIFLO + DMF**

<b>No.</b>	<b>Descriptions</b>	<b>3 MGD</b>	<b>5 MGD</b>	<b>10 MGD</b>	<b>15 MGD</b>
1	General Items	\$3,140,750	\$3,140,750	\$3,140,750	\$3,140,750
2	Operations & Maintenance Facilities	\$625,000	\$625,000	\$625,000	\$625,000
3	High Rate Clarification (Actiflo)	\$1,265,879	\$1,537,095	\$3,001,320	\$4,405,055
4	Filter Complex	\$1,914,019	\$2,272,165	\$2,817,430	\$3,565,295
5	Clearwell & Effluent Pumping Facilities	\$531,965	\$693,941	\$1,258,882	\$1,823,823
6	Plant Waste Handling	\$474,505	\$512,975	\$609,150	\$705,325
7	Chlorine Feed System Building	\$163,750	\$163,750	\$213,750	\$263,750
8	Sludge Drying Beds	\$178,870	\$241,970	\$434,720	\$592,470
9	Other	\$20,000	\$20,000	\$20,000	\$20,000
10	Construction Contingency (30%)	\$2,494,421	\$2,762,294	\$3,636,301	\$4,542,440
11	Engineering, Survey & Const Mngmnt (20%)	\$2,161,832	\$2,393,988	\$3,151,461	\$3,936,782
	<b>Total Capital Cost</b>	<b>\$12,970,991</b>	<b>\$14,363,928</b>	<b>\$18,908,763</b>	<b>\$23,620,690</b>

**Table 8-2 Estimate of Probable O&M Costs - Alternative A - ACTIFLO + DMF**

<b>No.</b>	<b>Descriptions</b>	<b>3 MGD</b>	<b>5 MGD</b>	<b>10 MGD</b>	<b>15 MGD</b>
1	Labor	\$327,000	\$327,000	\$422,000	\$562,000
2	Operation	\$229,500	\$280,500	\$561,500	\$834,000
3	Maintenance	\$40,000	\$40,000	\$60,000	\$70,000
4	Professional Services	\$45,000	\$45,000	\$45,000	\$45,000
5	Other	\$55,000	\$55,000	\$55,000	\$55,000
	<b>Total O&amp;M Cost</b>	<b>\$696,500</b>	<b>\$747,500</b>	<b>\$1,143,500</b>	<b>\$1,566,000</b>



**Table 8-3 Estimate of Probable Capital Costs - Alternative B - ACTIFLO + NF**

<b>No.</b>	<b>Descriptions</b>	<b>3 MGD</b>	<b>5 MGD</b>	<b>10 MGD</b>	<b>15 MGD</b>
1	General Items	\$3,140,750	\$3,140,750	\$3,140,750	\$3,140,750
2	Operations & Maintenance Facilities	\$625,000	\$625,000	\$625,000	\$625,000
3	High Rate Clarification (Actiflo)	\$1,265,879	\$1,537,095	\$3,001,320	\$4,405,055
4	NF Filter Complex	\$3,897,584	\$6,114,640	\$11,477,280	\$16,249,920
5	Clearwell & Effluent Pumping Facilities	\$529,165	\$691,941	\$1,213,882	\$1,825,823
6	Plant Waste Handling	\$474,505	\$512,975	\$560,150	\$705,325
7	Chlorine Feed System Building	\$163,750	\$163,750	\$213,750	\$263,750
8	Sludge Drying Beds	\$178,870	\$241,970	\$431,720	\$592,470
9	Other	\$20,000	\$20,000	\$20,000	\$20,000
10	Construction Contingency (30%)	\$3,088,651	\$3,914,436	\$6,205,156	\$8,348,428
11	Engineering, Survey & Const Mngmnt (20%)	\$2,676,831	\$3,392,511	\$5,377,802	\$7,235,304
	<b>Total Capital Cost</b>	<b>\$16,060,984</b>	<b>\$20,355,069</b>	<b>\$32,266,809</b>	<b>\$43,411,825</b>

**Table 8-4 Estimate of Probable O&M Costs - Alternative B - ACTIFLO + NF**

<b>No.</b>	<b>Descriptions</b>	<b>3 MGD</b>	<b>5 MGD</b>	<b>10 MGD</b>	<b>15 MGD</b>
1	Labor	\$414,000	\$414,000	\$422,000	\$699,000
2	Operation	\$1,596,500	\$2,366,500	\$4,706,500	\$7,051,500
3	Maintenance	\$200,000	\$200,000	\$260,000	\$350,000
4	Professional Services	\$45,000	\$45,000	\$45,000	\$45,000
5	Other	\$55,000	\$55,000	\$55,000	\$55,000
	<b>Total O&amp;M Cost</b>	<b>\$2,310,500</b>	<b>\$3,080,500</b>	<b>\$5,488,500</b>	<b>\$8,200,500</b>

**Table 8-5 Estimate of Probable Capital Costs - Alternative C - ACTIFLO + DMF+NF (No Blending)**

<b>No.</b>	<b>Descriptions</b>	<b>3 MGD</b>	<b>5 MGD</b>	<b>10 MGD</b>	<b>15 MGD</b>
1	General Items	\$3,140,750	\$3,140,750	\$3,140,750	\$3,140,750
2	Operations & Maintenance Facilities	\$625,000	\$625,000	\$625,000	\$625,000
3	High Rate Clarification (Actiflo)	\$1,265,879	\$1,537,095	\$3,001,320	\$4,405,055
4	NF Filter Complex + DMF	\$3,897,584	\$6,114,640	\$11,477,280	\$16,249,920
5	Clearwell & Effluent Pumping Facilities	\$531,965	\$693,941	\$1,213,882	\$1,823,823
6	Plant Waste Handling	\$474,505	\$512,975	\$560,150	\$705,325
7	Chlorine Feed System Building	\$163,750	\$163,750	\$213,750	\$263,750
8	Sludge Drying Beds	\$178,870	\$241,970	\$431,720	\$592,470
9	Other	\$1,979,019	\$2,367,165	\$2,987,430	\$3,810,295
10	Construction Contingency (30%)	\$3,677,196	\$4,619,186	\$7,095,385	\$9,484,916
11	Engineering, Survey & Const Mngmnt (20%)	\$3,186,904	\$4,003,294	\$6,149,333	\$8,220,261
	<b>Total Capital Cost</b>	<b>\$19,121,422</b>	<b>\$24,019,766</b>	<b>\$36,896,000</b>	<b>\$49,321,565</b>

**Table 8-6 Estimate of Probable O&M Costs - Alternative C - ACTIFLO + DMF+NF (No Blending)**

<b>No.</b>	<b>Descriptions</b>	<b>3 MGD</b>	<b>5 MGD</b>	<b>10 MGD</b>	<b>15 MGD</b>
1	Labor	\$464,000	\$464,000	\$567,000	\$849,000
2	Operation	\$1,773,000	\$2,594,000	\$5,161,500	\$7,734,000
3	Maintenance	\$240,000	\$240,000	\$320,000	\$420,000
4	Professional Services	\$45,000	\$45,000	\$45,000	\$45,000
5	Other	\$55,000	\$55,000	\$55,000	\$55,000
	<b>Total O&amp;M Cost</b>	<b>\$2,577,000</b>	<b>\$3,398,000</b>	<b>\$6,148,500</b>	<b>\$9,103,000</b>

**Table 8-7 Estimate of Probable Capital Costs - Alternative D - ACTIFLO + DMF+RO (No Blending)**

<b>No.</b>	<b>Descriptions</b>	<b>3 MGD</b>	<b>5 MGD</b>	<b>10 MGD</b>	<b>15 MGD</b>
1	General Items	\$3,140,750	\$3,140,750	\$3,140,750	\$3,140,750
2	Operations & Maintenance Facilities	\$625,000	\$625,000	\$625,000	\$625,000
3	High Rate Clarification (Actiflo)	\$1,265,879	\$1,537,095	\$3,001,320	\$4,405,055
4	RO Filter Complex + DMF	\$5,353,840	\$6,517,680	\$13,127,280	\$16,936,880
5	Clearwell & Effluent Pumping Facilities	\$531,965	\$693,941	\$1,213,882	\$1,823,823
6	Plant Waste Handling	\$474,505	\$512,975	\$560,150	\$705,325
7	Chlorine Feed System Building	\$163,750	\$163,750	\$213,750	\$263,750
8	Sludge Drying Beds	\$178,870	\$241,970	\$431,720	\$592,470
9	Other	\$1,979,019	\$2,367,165	\$2,987,430	\$3,810,295
10	Construction Contingency (30%)	\$4,114,073	\$4,740,098	\$7,590,385	\$9,691,004
11	Engineering, Survey & Const Mngmnt (20%)	\$3,565,530	\$4,108,085	\$6,578,333	\$8,398,870
	<b>Total Capital Cost</b>	<b>\$21,393,181</b>	<b>\$24,648,509</b>	<b>\$39,470,000</b>	<b>\$50,393,223</b>

**Table 8-8 Estimate of Probable O&M Costs - Alternative D - ACTIFLO + DMF+RO (No Blending)**

<b>No.</b>	<b>Descriptions</b>	<b>3 MGD</b>	<b>5 MGD</b>	<b>10 MGD</b>	<b>15 MGD</b>
1	Labor	\$704,000	\$704,000	\$707,000	\$981,000
2	Operation	\$2,393,000	\$3,419,000	\$6,811,500	\$10,209,000
3	Maintenance	\$250,000	\$250,000	\$400,000	\$500,000
4	Professional Services	\$45,000	\$45,000	\$45,000	\$45,000
5	Other	\$55,000	\$55,000	\$55,000	\$55,000
	<b>Total O&amp;M Cost</b>	<b>\$3,447,000</b>	<b>\$4,473,000</b>	<b>\$8,018,500</b>	<b>\$11,790,000</b>

**Table 8-9 Estimate of Probable Capital Costs - Alternative C - ACTIFLO + DMF+NF (Blending)**

<b>No.</b>	<b>Descriptions</b>	<b>3 MGD</b>	<b>5 MGD</b>	<b>10 MGD</b>	<b>15 MGD</b>
1	General Items	\$3,140,750	\$3,140,750	\$3,140,750	\$3,140,750
2	Operations & Maintenance Facilities	\$625,000	\$625,000	\$625,000	\$625,000
3	High Rate Clarification (Actiflo)	\$1,265,879	\$1,537,095	\$3,001,320	\$4,405,055
4	NF Filter Complex + DMF	\$2,728,309	\$4,280,248	\$8,034,096	\$11,374,944
5	Clearwell & Effluent Pumping Facilities	\$531,965	\$693,941	\$1,213,882	\$1,823,823
6	Plant Waste Handling	\$474,505	\$512,975	\$560,150	\$705,325
7	Chlorine Feed System Building	\$163,750	\$163,750	\$213,750	\$263,750
8	Sludge Drying Beds	\$178,870	\$241,970	\$431,720	\$592,470
9	Other	\$1,979,019	\$2,367,165	\$2,987,430	\$3,810,295
10	Construction Contingency (30%)	\$3,326,414	\$4,068,868	\$6,062,429	\$8,022,424
11	Engineering, Survey & Const Mngmnt (20%)	\$2,882,892	\$3,526,352	\$5,254,105	\$6,952,767
	<b>Total Capital Cost</b>	<b>\$17,297,352</b>	<b>\$21,158,115</b>	<b>\$31,524,633</b>	<b>\$41,716,603</b>

**Table 8-10 Estimate of Probable O&M Costs - Alternative C - ACTIFLO + DMF+NF (Blending)**

<b>No.</b>	<b>Descriptions</b>	<b>3 MGD</b>	<b>5 MGD</b>	<b>10 MGD</b>	<b>15 MGD</b>
1	Labor	\$464,000	\$464,000	\$567,000	\$849,000
2	Operation	\$1,314,000	\$1,904,000	\$3,781,500	\$5,664,000
3	Maintenance	\$240,000	\$240,000	\$320,000	\$420,000
4	Professional Services	\$45,000	\$45,000	\$45,000	\$45,000
5	Other	\$55,000	\$55,000	\$55,000	\$55,000
	<b>Total O&amp;M Cost</b>	<b>\$2,118,000</b>	<b>\$2,708,000</b>	<b>\$4,768,500</b>	<b>\$7,033,000</b>

**Table 8-11 Estimate of Probable Capital Costs - Alternative D - ACTIFLO + DMF+RO (Blending)**

<b>No.</b>	<b>Descriptions</b>	<b>3 MGD</b>	<b>5 MGD</b>	<b>10 MGD</b>	<b>15 MGD</b>
1	General Items	\$3,140,750	\$3,140,750	\$3,140,750	\$3,140,750
2	Operations & Maintenance Facilities	\$625,000	\$625,000	\$625,000	\$625,000
3	High Rate Clarification (Actiflo)	\$1,265,879	\$1,537,095	\$3,001,320	\$4,405,055
4	RO Filter Complex + DMF	\$3,603,840	\$4,267,680	\$7,627,280	\$9,686,880
5	Clearwell & Effluent Pumping Facilities	\$531,965	\$693,941	\$1,213,882	\$1,823,823
6	Plant Waste Handling	\$474,505	\$512,975	\$560,150	\$705,325
7	Chlorine Feed System Building	\$163,750	\$163,750	\$213,750	\$263,750
8	Sludge Drying Beds	\$178,870	\$241,970	\$431,720	\$592,470
9	Other	\$1,979,019	\$2,367,165	\$2,987,430	\$3,810,295
10	Construction Contingency (30%)	\$3,589,073	\$4,065,098	\$5,940,385	\$7,516,004
11	Engineering, Survey & Const Mngmnt (20%)	\$3,110,530	\$3,523,085	\$5,148,333	\$6,513,870
	<b>Total Capital Cost</b>	<b>\$18,663,181</b>	<b>\$21,138,509</b>	<b>\$30,890,000</b>	<b>\$39,083,223</b>

**Table 8-12 Estimate of Probable O&M Costs - Alternative D - ACTIFLO + DMF+RO (Blending)**

<b>No.</b>	<b>Descriptions</b>	<b>3 MGD</b>	<b>5 MGD</b>	<b>10 MGD</b>	<b>15 MGD</b>
1	Labor	\$704,000	\$704,000	\$707,000	\$981,000
2	Operation	\$1,211,000	\$1,974,000	\$3,921,500	\$5,874,000
3	Maintenance	\$250,000	\$250,000	\$400,000	\$500,000
4	Professional Services	\$45,000	\$45,000	\$45,000	\$45,000
5	Other	\$55,000	\$55,000	\$55,000	\$55,000
	<b>Total O&amp;M Cost</b>	<b>\$2,265,000</b>	<b>\$3,028,000</b>	<b>\$5,128,500</b>	<b>\$7,455,000</b>

**Table 8-13. Summary of Estimate of Probable Capital Costs (No Blending)**

CAPACITY	Alternative A	Alternative B	Alternative C	Alternative D
	ACTIFLO + DMF	ACTIFLO + NF	ACTIFLO + DMF + NF	ACTIFLO + DMF + RO
3 MGD	\$12,970,991	\$16,060,984	\$19,121,421.70	\$21,393,181.06
5 MGD	\$14,363,928	\$20,355,069	\$24,019,766.16	\$24,648,508.56
10 MGD	\$18,908,763	\$32,266,809	\$36,895,999.92	\$39,469,999.92
15 MGD	\$23,620,690	\$43,411,825	\$49,321,565.28	\$50,393,222.88

**Table 8-14: Summary of Estimate of Probable Annual O&M Costs (No Blending)**

CAPACITY	Alternative A	Alternative B	Alternative C	Alternative D
	ACTIFLO + DMF	ACTIFLO + NF	ACTIFLO + DMF + NF	ACTIFLO + DMF + RO
3 MGD	\$696,500	\$2,310,500	\$2,577,000	\$3,447,000
5 MGD	\$747,500	\$3,080,500	\$3,398,000	\$4,473,000
10 MGD	\$1,143,500	\$5,488,500	\$6,148,500	\$8,018,500
15 MGD	\$1,566,000	\$8,200,500	\$9,103,000	\$11,790,000

**Table 8-15. Summary of Estimate of Probable Capital Costs (Blending)**

CAPACITY	Alternative A	Alternative B	Alternative C	Alternative D
	ACTIFLO + DMF	ACTIFLO + NF	ACTIFLO + DMF + NF	ACTIFLO + DMF + RO
3 MGD	\$12,970,991	\$16,060,984	\$17,297,352.38	\$18,663,181.06
5 MGD	\$14,363,928	\$20,355,069	\$21,158,114.64	\$21,138,508.56
10 MGD	\$18,908,763	\$32,266,809	\$31,524,632.88	\$30,889,999.92
15 MGD	\$23,620,690	\$43,411,825	\$41,716,602.72	\$39,083,222.88

**Table 8-16: Summary of Estimate of Probable Annual O&M Costs (Blending)**

CAPACITY	Alternative A	Alternative B	Alternative C	Alternative D
	ACTIFLO + DMF	ACTIFLO + NF	ACTIFLO + DMF + NF	ACTIFLO + DMF + RO
3 MGD	\$696,500	\$2,310,500	\$2,118,000	\$2,265,000
5 MGD	\$747,500	\$3,080,500	\$2,708,000	\$3,028,000
10 MGD	\$1,143,500	\$5,488,500	\$4,768,500	\$5,128,500
15 MGD	\$1,566,000	\$8,200,500	\$7,033,000	\$7,455,000

**Table 8-17. Annualized Estimate of Probable Total Costs (\$) (No Blending)**

CAPACITY	Alternative A	Alternative B	Alternative C	Alternative D
	ACTIFLO + DMF	ACTIFLO + NF	ACTIFLO + DMF + NF	ACTIFLO + DMF + RO
3 MGD	\$1,638,828	\$3,477,313	\$3,966,150	\$5,001,191
5 MGD	\$1,791,024	\$4,559,274	\$5,143,010	\$6,263,687
10 MGD	\$2,517,201	\$7,832,649	\$8,828,954	\$10,885,953
15 MGD	\$3,282,017	\$11,354,322	\$12,686,158	\$15,451,013

**Table 8-18. Annualized Estimate of Probable Total Costs (\$) (Blending)**

CAPACITY	Alternative A	Alternative B	Alternative C	Alternative D
	ACTIFLO + DMF	ACTIFLO + NF	ACTIFLO + DMF + NF	ACTIFLO + DMF + RO
3 MGD	\$2,043,828	\$3,477,313	\$3,374,634	\$3,620,860
5 MGD	\$2,196,024	\$4,559,274	\$4,245,114	\$4,563,690
10 MGD	\$2,517,201	\$7,832,649	\$7,058,730	\$7,372,625
15 MGD	\$3,282,017	\$11,354,322	\$10,063,666	\$10,294,354



**Table 8-19. Annualized Estimate of Probable Total Costs (\$/1000 gallon) (No Blending)**

CAPACITY	Alternative A	Alternative B	Alternative C	Alternative D
	ACTIFLO + DMF	ACTIFLO + NF	ACTIFLO + DMF + NF	ACTIFLO + DMF + RO
3 MGD	\$1.50	\$3.18	\$3.62	\$4.57
5 MGD	\$0.98	\$2.50	\$2.82	\$3.43
10 MGD	\$0.69	\$2.15	\$2.42	\$2.98
15 MGD	\$0.60	\$2.07	\$2.32	\$2.82

**Table 8-20. Annualized Estimate of Probable Total Costs (\$/1000 gallon) (Blending)**

CAPACITY	Alternative A	Alternative B	Alternative C	Alternative D
	ACTIFLO + DMF	ACTIFLO + NF	ACTIFLO + DMF + NF	ACTIFLO + DMF + RO
3 MGD	\$1.50	\$3.18	\$3.08	\$3.31
5 MGD	\$0.98	\$2.50	\$2.33	\$2.50
10 MGD	\$0.69	\$2.15	\$1.93	\$2.02
15 MGD	\$0.60	\$2.07	\$1.84	\$1.88

## 9 Summary Conclusions and Recommendations

### Summary

The purpose of this Regional Water Supply Facilities Plan was to identify and evaluate potential project sites, drinking water treatment processes, and facilities required to develop drainage water within the Hidalgo County Drainage District No.1 drainage systems as a potential alternative water source to supply treated water to areas within the Hidalgo County in the near future through 2060.

Facilities related to raw water diversion, storage, and conveyance were proposed. The proposed facilities include a weir structure located just downstream of the diversion intake structure on the drainage ditch to ensure a steady water level for diversion during normal base flow conditions, a diversion intake structure with screen to divert raw water from the drainage ditch to a wet well (concrete vault) via a pipeline by gravity, a pump station (Pump Station I) to lift the raw water from the wet well to a raw water storage basin which ensures reliable water supply to the treatment plant, a second pump station to provide feed water to the water treatment plant, a floodwater detention basin to store floodwater during wet season and supplement normal base flow drainage water during dry season, a side weir structure to divert floodwater to the floodwater detention basin via a open



channel by gravity, and a pipeline between the floodwater detention basin and the raw water storage basin and a pipe between the floodwater detention basin and wet well to convey floodwater to the raw water storage basin by gravity.

Water quality samples were collected for the raw water from the drainage ditches and water quality parameters were determined by laboratory test analysis. Three potential project sites were identified and evaluated to divert and treat raw drainage water. Each site was evaluated with consideration of availability of dependable water, floodplain, topography, accessibility, land use and land cover, and environmental concerns. EPA and TCEQ current drinking water standards and rules were extensively reviewed and target finished water quality targets were developed.

Based on the raw water quality parameters and treated water quality requirements, four alternative water treatment processes were evaluated, including conventional and membrane treatment process units.

Conceptual designs with design data were developed for each of the four alternative treatment processes. Also, three alternative building arrangement layouts were developed. Based on the conceptual designs, conceptual capital costs and annual O&M costs were developed for each alternative treatment process and four treatment capacities were considered. Cost comparison analysis was performed based on annual costs. Annualized capital cost and annual O&M cost were summed to obtain the total annual cost for each alternative and treatment capacity. Life cycle present value analysis was not performed for the purpose of this study.

## Conclusions

The following conclusions were obtained:

1. The untreated water has a high TDS of approximately 2000 mg/. It is considered very hard with a hardness of approximately 600 mg/L as CaCO<sub>3</sub> and brackish based on the high TDS and chloride in the water.
2. SITE III on the Main Floodwater Channel is the most promising site for water diversion and treatment site, which has the most reliable water supply source and has the potential for future expansion.
3. The preferred treatment process alternatives are the integrated membrane systems: (1) ACTIFLO followed DMF and NF, and (2) ACTIFLO followed DMF and RO with consideration of both performance and costs.
4. The proposed development strategy and treatment processes are technically and economically

feasible to develop the drainage ditch water to meet some of the future water needs in the Hidalgo County.

## Recommendations

1. Conduct a pilot study to determine the optimal blending ratio for Alternative C that ACTIFLO is followed by DMF and NF and alternative D that ACTIFLO is followed by DMF and RO.
2. Should be included in the TWDB's 2010 Region M Water Plan for the Rio Grande area as a viable water development strategy.