

TEXAS WATER COMMISSION

Joe D. Carter, Chairman
O. F. Dent, Commissioner
H. A. Beckwith, Commissioner

BULLETIN 6401

RESEARCH ON EVAPORATION RETARDATION

IN SMALL RESERVOIRS

1958-63

By

Wilmon W. Meinke

Associate Research Chemist and
Head, Chemurgic Research Laboratory,
Texas Engineering Experiment Station,
and Associate Professor of Chemical Engineering

and

William J. Waldrip

Assistant Range Specialist,
Texas Agricultural Experiment Station

Summary Report of Research Performed
by the Texas A & M Research Foundation
for the Texas Water Commission

March 1964



ACKNOWLEDGMENT

The early efforts of the Southwest Water Evaporation Research Council--now the Southwest Water Research Council--in securing funds for the evaporation-control studies is gratefully acknowledged. This acknowledgment is directed not only to the Council as an organization but also to the individual members who have devoted a great deal of effort to the activities of the Council. In this respect, the efforts of Mr. Uel Stephens, Secretary-Treasurer of the Council, in behalf of the Council and their research projects must receive special mention.

Legislative actions which provided continuing funds for this research program demonstrate the concern of both the members of the Senate and the House of Representatives in preserving impounded water supplies of the State.

The contribution to this study of the Geological Survey of the U. S. Department of Interior also is recognized. Efforts by personnel of this organization in behalf of this research program and instrumentation provided for the collection of field data at Throckmorton are duly acknowledged.

Many industrial firms also provided generous quantities of experimental materials for this water evaporation control investigation. Such contributions by Arista Industries, Proctor and Gamble, Atlas Chemical Industries, M. Michel & Company, MMM Incorporated, and Sun Plastics, Incorporated are herewith acknowledged.



TABLE OF CONTENTS

	Page
ABSTRACT.....	1
INTRODUCTION.....	3
CHEMICAL-FILM TECHNIQUE--THEORY AND HISTORICAL DEVELOPMENT FOR EVAPORATION CONTROL.....	7
FILM-CHEMICAL ADDITION--METHODS AND PROBLEMS AS RELATED TO SMALL RANCH AND FARM PONDS.....	8
LABORATORY AND SMALL-SCALE EVAPORATION STUDIES.....	9
Film-Chemical Application by Isopropanol Solutions.....	9
Film-Chemical Application by Solid Emulsions.....	12
Evaporation and Evaporation-Control Studies with Small Field Test Pans.....	19
Evaporation-Control Investigations Under Controlled- Environment Conditions.....	27
Microbiological Aspects of Evaporation Control by Film Chemicals.....	38
Investigation of Film Movement on a Body of Water as Influenced by Surface Wind Travel.....	39
Preparation and Properties of Liquid Emulsions of Aquasave.....	41
EVAPORATION-CONTROL FIELD STUDIES ON TWIN PONDS.....	47
Description of the Facility.....	47
Descriptions of Tests Performed.....	49
Test T1, July 7 to August 25, 1959.....	49
Test T2, September 11 to November 19, 1959.....	50



TABLE OF CONTENTS (Cont'd.)

	Page
Test T3, April 21 to August 8, 1960.....	51
Test T4, August 17 to August 29, 1960.....	53
Test T5, April, 1961.....	55
Test T6, July 6 to July 22, 1961.....	55
Test T7, August 14 to August 25, 1961.....	57
Test T8, March 13 to May 22, 1962.....	60
Test T9, June 22 to August 7, 1962.....	61
Test T10, April 22 to May 17, 1963.....	62
Test T11, May 21 to May 31, 1963.....	63
Test T12, July 31 to August 19, 1963.....	65
Test T13, August 20 to September 10, 1963.....	69
Test T14, September 12, 1963.....	72
DISCUSSION OF RESULTS.....	74
ECONOMICS OF WATER EVAPORATION CONTROL ON SMALL RANCH AND FARM PONDS...	78
FURTHER RESEARCH NEEDS.....	80
REFERENCES.....	83

TABLES

1. Film width as a function of rate of addition of a solution of hexadecanol in isopropanol.....	11
2. Rate of dispersion of some solid-rod emulsions.....	14
3. Study of effect of some emulsifiers on rate of emulsion dispersion.....	15
4. Comparison of rates of dispersion of octadecanol from chunk forms of emulsion and rods of emulsion.....	16
5. Small-tank studies on methods of aquasave application.....	21
6. Water savings as obtained by rod emulsions and isopropanol solutions of aquasave 1-SD in small tanks.....	22



TABLE OF CONTENTS (Cont'd.)

	Page
7. Some factors relating to small-tank evaporation-control studies...	24
8. Rigid foam particles as evaporation retardants.....	26
9. Evaporation rates from small metal containers as a function of the physical installation.....	28
10. Evaporation studies in controlled-environment chamber with shallow pans.....	29
11. Evaporation studies in controlled-environment chamber with deep cans.....	30
12. Film movement as a function of wind travel.....	40
13. Liquid-emulsion flow rate as influenced by hose diameter.....	45
14. Rod-emulsion test T4 on twin ponds.....	54
15. Twin-pond field test of water-soluble bags of a powdered hexa-octadecanol mixture.....	56
16. Twin-pond test with emulsion 211 without mineral oil.....	58
17. Dispersion-rate studies of a series of solid emulsions from floating 1/8- and 1/4-inch-mesh cylinders.....	64
18. Evaporation studies with solid emulsion 211C in 1/8-inch-mesh baskets.....	71
19. Wind velocities on water surfaces of control and test ponds.....	73
20. Evaporation costs versus method of application on twin-pond facilities.....	77

ILLUSTRATIONS

Figures

1. Average Annual Net Lake-Surface Evaporation in Texas.....	4
2. Average Annual Rainfall in Texas.....	5
3. Constant-Head Device for Dispensing a Solvent Solution of Fatty Alcohol.....	10
4. Forms of Solid Emulsion Tested.....	17

TABLE OF CONTENTS (Cont'd.)

	Page
5. Controlled-Environment-Chamber Setups:	
A. Evaporation Studies with Pans.....	31
B. Evaporation Studies with Cans.....	31
6. Water Saved as a Function of Wind Velocity and Temperature at Constant Relative Humidity, Shallow-Pan Studies in Controlled- Environment Chamber.....	34
7. Water Saved as a Function of Wind Velocity and Relative Humidity at Constant Temperature, Deep-Tank Studies in Controlled- Environment Chamber.....	35
8. Comparisons of Water Saved with Shallow Pans and with Deep Tanks in Controlled-Environment Chamber.....	36
9. Rate of Flow of Liquid Emulsion P-3 Through 5/16-Inch (I. D.) Hose.....	44
10. Liquid-Emulsion Flow Through 30-Foot, 5/16-Inch (I. D.) Hose at 25°C.....	46
11. Sketch Map of the Large Earthen Dam and Twin-Pond Test Facility, Throckmorton County.....	48
12. Constant-Pressure Dripper for Dispensing a Solvent Solution of Fatty Alcohol.....	52
13. Film-Pressure Measurements Under Varying Wind Direction on the Test Pond in Throckmorton County.....	59
14. Constant-Head Device for Dispensing Liquid Emulsion.....	67
15. Operational Constant-Head Device for Dispensing Liquid Emulsion...	68



RESEARCH ON EVAPORATION RETARDATION IN
SMALL RESERVOIRS

1958 - 63

ABSTRACT

Prices of 1 to 2 cents per 1,000 gallons of water saved, reported in earlier evaporation-control investigations for large bodies of water, are not realistic for small ranch and farm ponds. Laboratory studies on evaporation in a controlled-environment chamber in the Texas A & M Research Foundation indicate that the cost for a 1-acre pond would be 8.4 to 90.0 cents per 1,000 gallons of water saved.

These costs apply to a hypothetical 1-acre pond exposing 100 feet of shoreline normal to the prevailing wind and 435.6 feet long in the downward direction. For a pond of the same size but exposing twice as much shoreline normal to the prevailing wind, the cost per unit volume of water saved would be doubled.

Subsequent field tests on twin-pond test facilities in Throckmorton County, Texas, provide costs of \$1.02 to \$2.45 per 1,000 gallons of water saved from a 1/6-acre body of water that presented about 100 feet of shoreline normal to the prevailing wind. This means that for a 1-acre body of water, the film-chemical costs for saving 1,000 gallons of water would be in the range of 17 to 43 cents.

The above costs refer to the amount of water saved per unit weight of film chemical applied. Actual gallons of water saved is a function of pond dimensions, prevailing temperature, relative humidity of the wind blowing over the water surface, the temperature of the water, and the velocity of the prevailing wind at the water surface. The quantity of film chemical needed is a function of the wind velocity at the water surface and the length of shoreline of the pond exposed normal to the prevailing wind.

Field investigations show that a chemical film travels approximately 3.4 feet for each 100 feet of surface wind travel. Based on this film travel, an estimated 0.5 pound of film chemical per day per mile per hour of wind travel must be applied for each 100 feet of shoreline normal to the prevailing wind in order to maintain a continuous film on the downwind water surface. For example, with a pond exposing 200 feet of shoreline to a 4 mile per hour prevailing wind, a total of 4 pounds of film chemical per day should be added to the water surface near the upwind shoreline. Application of the film chemical should be continuous and at a number of points.

Both solid and liquid emulsions of straight chain saturated fatty alcohols have been developed to add the film cover to the water surfaces in a continuous manner as demanded by the surface wind velocity. Film chemical may also be applied as a solution in isopropanol, although the isopropanol adds cost to an evaporation-control program. Solid emulsions have a "built-in" feature that permits film-chemical addition to the water surface as a function of the wind velocity, whereas the liquid emulsions must be applied by a wind-regulated distribution system. [Application or use of the liquid emulsion technique, regardless of method of application is covered and protected by U. S. Patent 2,903,330, issued in December 1959 to Russell G. Dressler, Chemical Process Consultant of San Antonio, and permission to use the process must be obtained under license agreement.]

RESEARCH ON EVAPORATION RETARDATION
IN SMALL RESERVOIRS

1958 - 63

INTRODUCTION

The contour lines presented in Figure 1 show water losses in Texas due to evaporation from impounded bodies of water such as lakes, reservoirs, and ponds, which range from approximately 10 inches per year in the area of the Sabine River to a maximum of 90 to 100 inches per year in the Big Bend section. Figure 2, which presents average annual rainfall for the State, shows that the maximum rainfall, 55 inches per year, occurs in the area of minimum evaporation rate and the minimum rainfall, 10 to 15 inches per year, is in the area of maximum evaporation rate. It is evident that water reservoirs located in most of West Texas are subject to evaporation losses greater than 50 inches per year and are replenished by rainfalls of about 25 inches per year and less.

More than half of the land area of the State of Texas is in a region of high water evaporation rate and low rainfall. In this region the ponds of small water surface area located on farms and ranches supply water for livestock and often for domestic use after purification. The true economic value of such small bodies of water to the ranches may not be apparent except under drought conditions when the ponds go dry. Under such conditions, and based on the average consumption of 8 gallons of water per day per animal on range, a rancher is commonly forced to expend as much as \$6.00 per day to provide an average water supply, 1,000 gallons, for 125 head of cattle.

Assuming that these cattle were supplied daily with 1,000 gallons of water for a year from a 1-acre pond, a total of 365,000 gallons or approximately 1.12 acre-feet of water would be required. Evaporation losses of 50 and 100 inches per year from such a 1-acre pond would represent the loss of 4.17 and 8.34 acre-feet of water per year, respectively. Based on such watering practices and evaporation rates on a 1-acre pond, 88.2 percent of the water is lost by evaporation and only 11.8 percent of the water is consumed by the cattle in areas where the annual evaporation rate is 100 inches. In areas of 50-inch per year evaporation 78.8 percent of this water is lost by evaporation and 21.2 percent may be used by cattle. Similar conclusions have been expressed in different ways. Yearly evaporation losses from the livestock ponds in areas of 75-inch annual evaporation rates are sufficient to supply the water needs for 1 year for 500 head of cattle (Eaton, 1958). During a 6-month test period the water taken from a farm pond by evaporation was reported to be 10 times as much as the amount taken for use (Crowe and Daniels, 1956).

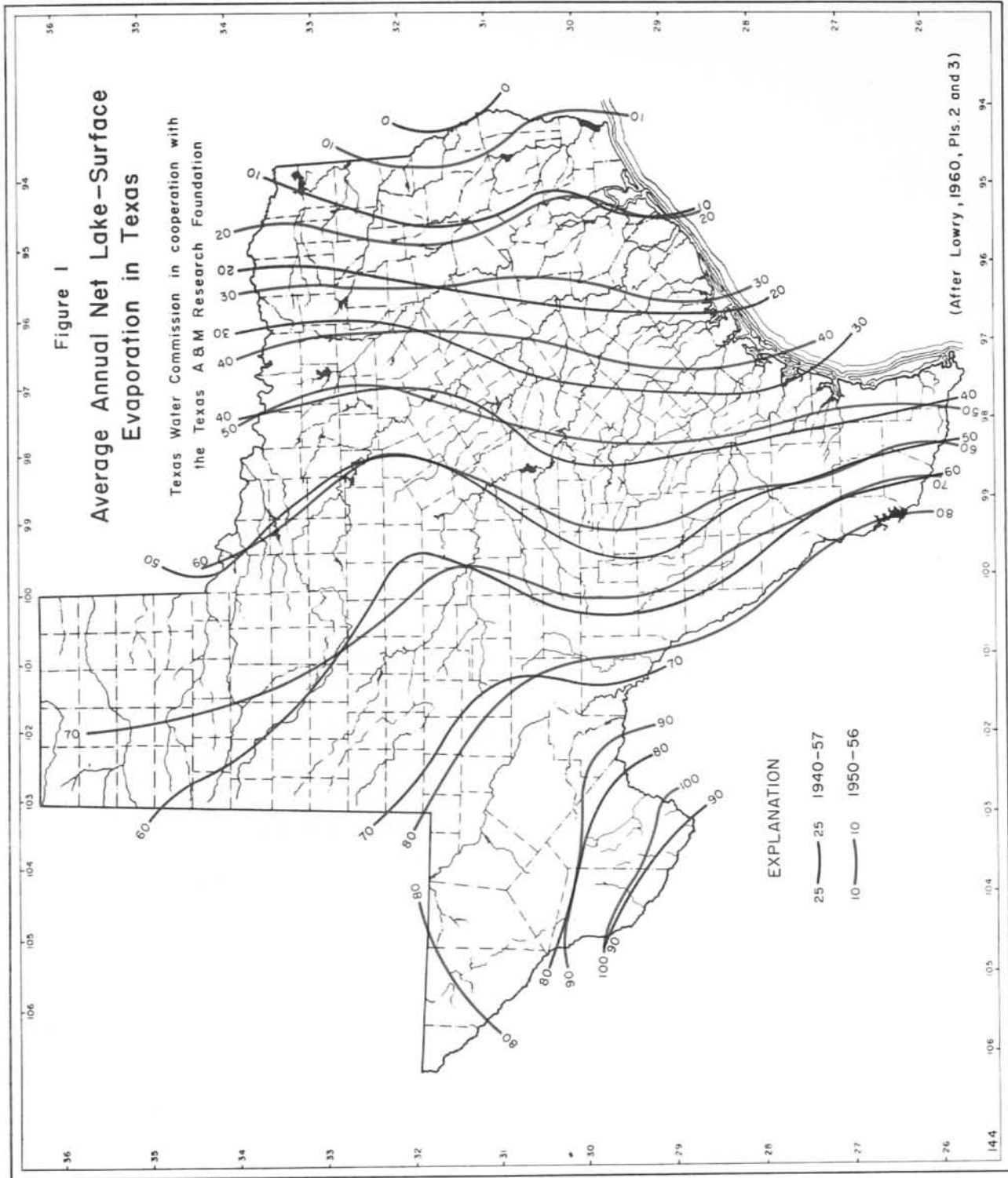

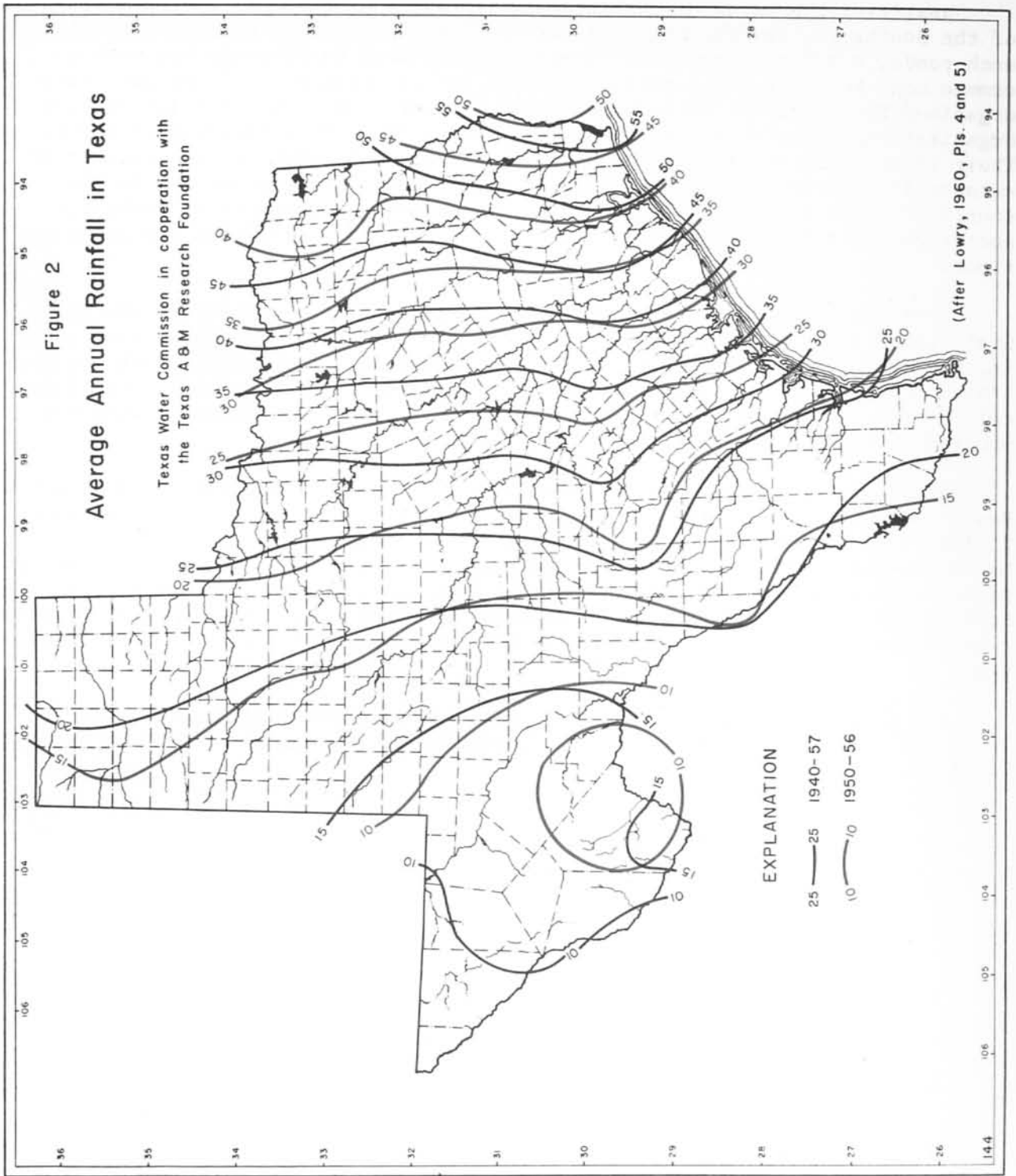

Realizing the value of the water in livestock ponds to farmers and ranchers of the Southwest, and the magnitude of the loss of water by evaporation from such ponds, a group of men with diverse professional backgrounds but with a common concern for water supplies in Texas met in December 1955 and soon after organized The Southwest Water Evaporation Council, Inc. The function of this organization was to stimulate research programs in water-evaporation control. Their efforts in this respect provided in excess of \$44,000 for the support of evaporation-control research. This financial assistance was secured by the Council through donations from municipalities, private industries, technical societies, consulting engineers, and other interested individuals and organizations.

Funds collected by the Council were placed under the control of the Texas State Board of Water Engineers (predecessor of the Texas Water Commission); that is, the Board acted as the official contracting agency and fiscal agent for the Finance Committee of the Water Evaporation Control Research Council. All funds collected by the Council were used to support an evaporation-control-research program by The Southwest Research Institute.

State monies financed a continuance of this research program at Texas A & M Research Foundation for the period August 1, 1958 to August 31, 1963. On August 1, 1958, the sum of \$25,000 for the program was budgeted by the then Board of Water Engineers from funds provided by legislative enactment for water-resources planning. Later, combined actions of the 56th and 57th Legislatures of the State of Texas provided evaporation-control research funds totaling \$60,000 between September 1, 1959 and August 31, 1963, the date of termination of the program.

The following report presents the data and research findings obtained at Texas A & M University for the period beginning in the summer of 1958 to August 31, 1963.

CHEMICAL-FILM TECHNIQUE--THEORY AND HISTORICAL DEVELOPMENT FOR EVAPORATION CONTROL

The chemical compound to be employed in creating a film or barrier on the surface of bodies of water must be of low water solubility and must contain a hydrophylic, water-loving grouping and a hydrophobic, water-hating grouping. When such a chemical forms a film on the surface of the water the individual molecules of the compound orient themselves in a specific manner. The hydrophylic group is contained in or oriented toward the water surface and the hydrophobic group is oriented toward or in the air immediately above the water surface. When adequate chemical is dispersed to the water surface to form a compressed film, the hydrophobic portion of the compound is oriented essentially perpendicularly to the water surface, whereas in the absence of a compressed film there is an inclination of the hydrophobic grouping toward the water surface. For effective evaporation control, a compressed film of the chemical molecules is required. These compressed or condensed films of the long chain fatty alcohols, such as hexa- and octadecanol or mixtures thereof, exert an equilibrium pressure of 40 dynes per centimeter--a condition which affords maximum resistance to the escape of water molecules from the water surface to the air above the water.

Many chemical compounds have been screened (Cruse and Harbeck, 1960) for their ability to decrease water losses due to evaporation. However, the long chain fatty alcohols such as hexadecanol (cetyl alcohol) and octadecanol (stearyl alcohol), or mixtures of the two, have been employed in most of the field studies. The actual quantity of octadecanol or hexadecanol required to cover 1 acre of water surface may be calculated from values reported for the cross-sectional area of the $-\text{CH}_2\text{OH}$ part of the fatty alcohol, and by using avogadro's number (6.06×10^{23} molecules per gram mole of the alcohol). For the normal straight long chain alcohols, the cross-sectional area of the $-\text{CH}_2\text{OH}$ group is 21.7 \AA^2 (square Angstrom units) at low pressures and 20.2 \AA^2 at high pressures (Weiser, 1939). Using the above figures as applied to octadecanol, the quantity required to form a compressed monolayer on 1 acre of water is calculated to be 8.4 grams for the 21.7 \AA^2 cross-sectional area, and 9.0 grams for the 20.2 \AA^2 cross-sectional area. For hexadecanol the quantities would be 8.9 and 9.5 grams per acre, respectively, for the high and low cross-sectional area figures. In essence, the figures suggest the use of about 0.02 pounds (9.08 grams) of film chemical such as hexa- and octadecanol or mixtures thereof to form a compressed film on 1 acre of water surface.

Most of the early work on evaporation control by the chemical-film procedure has been confined to large bodies of water--namely lakes. Mansfield (1953, 1955) in Australia was the pioneer in this endeavor and has reported water saving of 30 percent at a cost ranging from 1 to 2 cents per 1,000 gallons of water saved. The Lake Hefner study (Committee of Collaborators, 1959) provided a 9 percent water saving at a cost of \$60 per acre-foot of water saved (less than 2 cents per 1,000 gallons of water saved). Application of film chemical in the Lake Hefner study was realized by pumping a water slurry of a finely powdered cetyl alcohol from a moving motorboat or raft. Australian investigations (Chemical & Engineering News, 1960) employed a combined grinder and duster aboard a powerboat to apply a fine powder of cetyl alcohol to a lake surface. Such mechanized application procedures would be an impossibility on the small ranch or farm pond. As will be shown in subsequent discussions of this report, these prices of 1 to 2 cents per 1,000 gallons of water saved are far from realistic for the small livestock pond.

FILM-CHEMICAL ADDITION--METHODS AND PROBLEMS AS
RELATED TO SMALL RANCH AND FARM PONDS

Livestock-watering ponds in general are widely separated from one other, and the remote location of such reservoirs precludes the economic installation of power lines to provide electricity for the operation of film-chemical dispensing units. Likewise, providing power with combustion engines would be expensive owing to initial installation cost, fuel, equipment maintenance, and labor. The film-chemical dispensing unit for small ponds thus has peculiar requirements. It should be operable by nontechnical personnel and should require minimum labor for equipment maintenance and for addition of film chemical to the units. It should provide film chemical to the water surface at multiple points along variable upwind shorelines (as created by shifts in the direction of prevailing wind) and should supply the film chemical at variable rates as a function of the velocity of the prevailing wind.

Multiple points of chemical addition along the upwind shoreline are necessary to approach complete water-surface coverage by the film. Single-point addition is undesirable because this may produce only a downwind streak of film on the water surface. The streaking effect also may be obtained with multiple points of chemical addition during periods of high surface wind travel; therefore, the dispensing unit should be flexible enough in operational features to supply the film chemical to the water surface near the upwind shoreline--a location which may be changed by wind shifts of as much as 180 degrees within a given day. In lieu of such a single dispensing unit, a number of simpler units with valves opened and closed by wind vanes may be installed around the entire shoreline of the pond. The windvane regulating the valve for each unit should be arranged to supply film from the upwind dispensers and, at the same time, close the valves of the downwind dispensers. Such application units would be suitable for either solutions or emulsions of the film chemical. A blower or a combined grinder and blower powered by a windmill could be used to apply a powder to the water surface; however, the need for multiple points of addition and the equipment cost involved do not suggest the use of this technique for the small livestock pond.

Greater economy--lower cost of film chemical per unit volume of water saved--is realized if the film chemical is added continuously as a function of the wind velocity. During periods of calm, little or no film-chemical addition is required for a water surface that has already been treated with an evaporation retardant. However, with increasing wind, the amount of film chemical needed also increases. A windmill geared to a metering pump, for delivering either organic solvent solutions (of the long chain water insoluble fatty alcohols) or liquid emulsions (of the fatty alcohols), would provide addition of film chemical as needed, that is, as a function of the surface wind travel over the water.

It is evident that wind travel is both desirable and undesirable in reference to a water evaporation-control program based on the chemical-film method. Wind travel is desirable in that it assists in the downwind spread of the film chemical. It also is a potential source of power for dispensing units. Variable direction of wind flow over the water surface requires the expenditure of more dollars for dispensing units capable of providing film-chemical addition at the proper "upwind shoreline," whereas actual total wind travel is more closely associated with the amount of film chemical required. A film applied

to a body of water is carried across the water surface by the wind and deposited upon the downwind shoreline. In the absence of recirculation, which does not seem possible except by a wind shift, the film chemical is lost for evaporation-control purposes. With a 5 mph (mile per hour) prevailing wind blowing over a pond 100 feet long in the direction of wind travel, a chemical film applied at the upwind shoreline will traverse the water to the downwind shoreline in approximately 16 minutes. With a 10 mph wind the residence time of the film on the water would be 8 minutes. Thus, wind velocity or total wind travel over a reservoir is an important factor in the economics of an evaporation-control program in that it is the most important single factor in determining the quantity of film chemical that must be applied continuously at the upwind shoreline to maintain a film on the water surface at all times.

LABORATORY AND SMALL-SCALE EVAPORATION STUDIES

Film-Chemical Application by Isopropanol Solutions

In initial experimental approaches, film-chemical addition as a solution in isopropanol was studied. For this approach, at Texas A & M University, the site of all laboratory and small-scale studies, approximately 100 grams of hexadecanol was dissolved in 500 ml of isopropanol. This solution was placed in the reservoir of a constant-head dripper shown by Figure 3. Liquid flowed from the reservoir bottle until the liquid level in the constant-head part of the dispenser and the short leg of the J tube was just covered with liquid. A capillary tube, fitted to the end of the discharge pipe from the windvane-regulated valve, served as a means of controlling the rate of flow of solution from the unit. The solution from the capillary dripper was discharged onto the water contained in a pan 30 by 40 inches, 1-inch deep. The capillary delivered the hexadecanol solution at a rate of 0.4 cc (cubic centimeters) per minute, far in excess of the quantity needed to provide a compressed film on the water surface.

This solution-dispensing unit functioned properly over a 2-day test period at daytime maximum temperatures ranging from 90 to 95°F and at wind velocities in excess of 15 miles per hour. The capillary showed no tendency to clog due to possible crystallization of the hexadecanol. Under such application conditions the rate of evaporation was reduced by approximately 75 percent. That is, in the absence of the film the water evaporated from the pan in about 1/2 day, whereas with the film the water was retained in the pan up to 2 days.

The dripper next was used on a larger body of water. The solution of hexadecanol used was prepared by dissolving 760 grams of hexadecanol in 3,800 ml (milliliters) of isopropanol. The addition of 1.28 ml of the solution per minute to the water near the upwind shoreline produced a strip of film approximately 20 feet wide across the water surface. This test was run at wind velocities ranging from 13 to 15 mph. The dispenser functioned properly but wind shifts caused the valve to shut and therefore film-chemical addition was interrupted. A valve having 140 to 170 degrees wind-shift allowable, rather than the 60 degrees allowable of the valve attached to the unit, may be desirable.

In another test on the lake with the constant-head dripper, a 20 percent (by weight) solution of hexadecanol was applied at rates increasing from 0.2 to 8.7 ml per minute. Data obtained in this investigation (Table 1), show that there is an approach to a linear relationship between film width and rate of

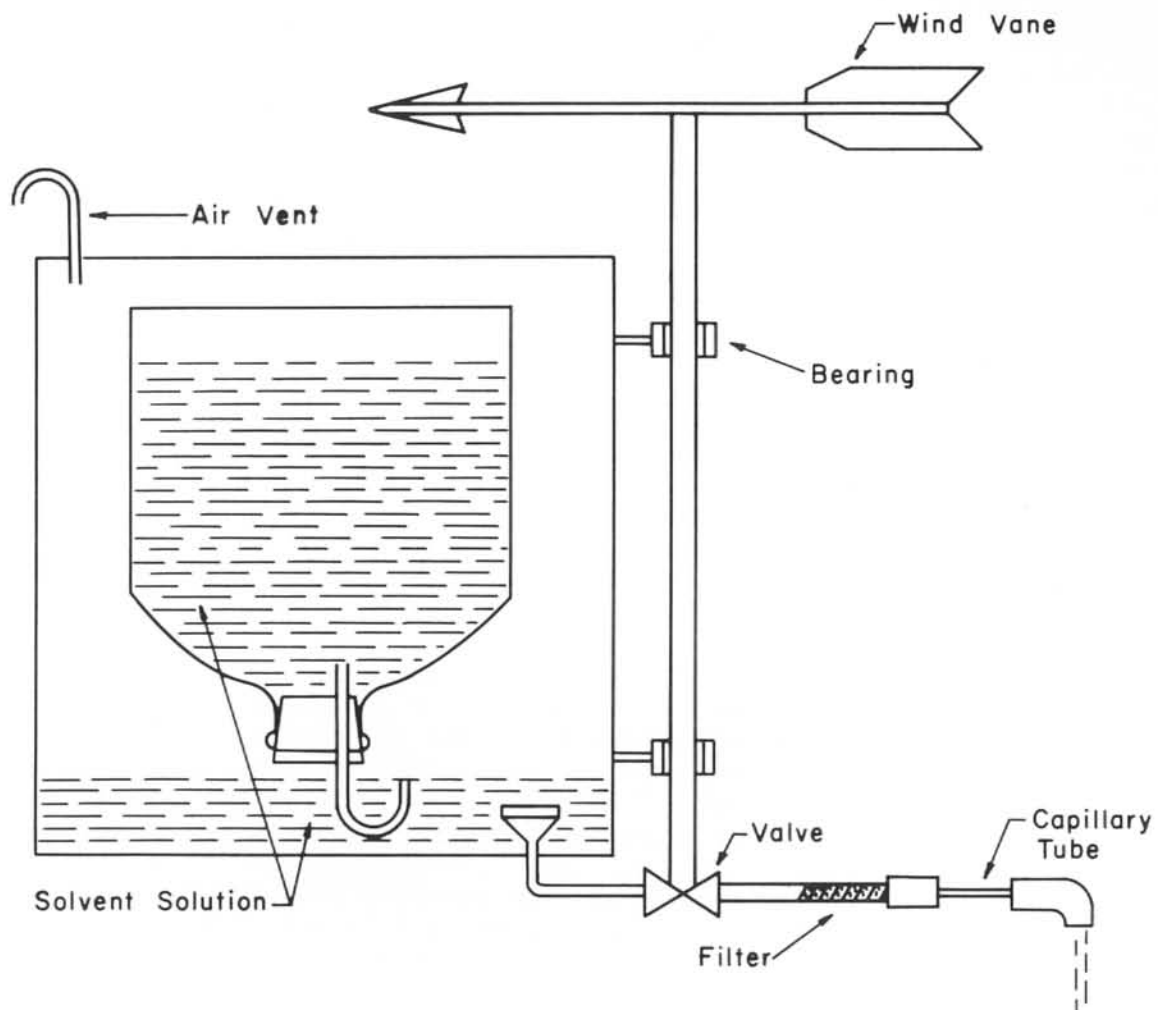

Figure 3
 Constant-Head Device for Dispensing a Solvent
 Solution of Fatty Alcohol

Texas Water Commission in cooperation with the Texas A & M Research Foundation

Table 1.--Film width^{a/} as a function of rate of addition of a solution^{b/} of hexadecanol in isopropanol

Wind travel (ft. per min.)	Solution addition rate (ml per min.)	Film width (feet)
563	0.2	7
862	.4	8
819	.7	12
880	1.0	15
972	2.2	30
884	8.7	80

^{a/} Maximum width obtained on a lake 300 yards in the downwind direction.

^{b/} 780 grams hexadecanol dissolved in 3,800 ml of 99 percent isopropanol; 1 ml of solution contains approximately 0.166 grams of hexadecanol.

solution addition--at least in the range of 0.4 to 2.2 ml of solution per minute. Data in this range, when plotted, show an increase in film width of 12.34 feet per ml of solution at a wind travel of about 10 mph (880 feet per minute). Visual observation of the film suggested that the addition of a minimum of 1 ml of solution per minute was needed to provide a compressed film or a film that did not break up during its travel across the water. This minimum volume of solution, representing 0.166 grams of hexadecanol and 0.833 ml of 99 percent isopropanol, would mean that 0.53 pounds of hexadecanol and 0.32 gallons of isopropanol would be added over a 24-hour period. It is obvious that the isopropanol would add to the cost of a water-saving program. With hexadecanol at 48 cents per pound, the total cost for hexadecanol per day would be 25 cents. The isopropanol, at 72 cents per gallon, would bring the daily cost of the hexadecanol and alcohol to 48 cents. The alcohol would represent about 48 percent of the combined costs.

These basic data point to the merits of applying the film chemical as a solution in organic solvent: a simple nonpowered dispenser may be used, application may be regulated as a function of wind direction, and an effective evaporation-retardant film may be created on the water surface. However, one dispenser will provide only a streak of film on the water; therefore, to provide essentially complete water-surface coverage, 4 or 5 dispensers may be required for each 100 feet of shoreline normal to the prevailing wind. Likewise, variable "upwind shorelines," due to changes in wind direction, would require more drippers or the relocation of existing drippers.

Film-Chemical Application by Solid Emulsions

The additional cost of applying the film chemical as a solution in organic solvents, such as isopropanol, ethanol hexane, kerosene, etc., suggested an investigation directed toward the development of a solid water emulsion of the fatty alcohol that would release the film chemical at a rate capable of maintaining a compressed film on the water surface. Solid preparations of the pure chemical, such as hexa- and octadecanol or mixtures thereof, in the form of chunks, beads, and blocks contained in floats near the upwind shoreline, are limited in their ability to provide adequate coverage--at least where surface winds of some magnitude exist.

In the earlier phases of this research, emulsion mixtures were prepared and poured into the form of a rod, 1 inch in diameter and 2 inches long, around a small wooden stick. The stick merely provided a means of handling the small rod of emulsion. One rod of each emulsion was placed in a beaker of water to ascertain the stability of the rod. The second rod, if the beaker test indicated adequate rod stability, was evaluated for rate of dispersion. For this procedure, a pan 30 by 40 inches, 1-inch deep was filled to a depth of approximately 3/4 inch with water. The surface then was dusted lightly with aluminum powder, and the rod was placed in the water against the midpoint of the 30-inch width of the pan. As the rod dispersed the film chemical, the aluminum powder was forced from the water surface. The time required for complete film coverage, as evidenced by the presence of the aluminum powder only around the side of the pan, was noted.

From the 56 emulsion mixtures screened by these two procedures, emulsion No. 54 was selected for field testing on experimental twin ponds. This emulsion

formulation^{1/} seemed the most desirable from the standpoint of structural stability when placed in water and had good spreading features on the test pan; that is, complete coverage of the 120-square-inch water surface in 40 seconds was obtained by the film chemical (Aquasave), a 50:50 mixture of hexadecanol and octadecanol.

Field tests on the twin-pond test facility in Throckmorton County, the results of which are presented in this report's section on field testing, provided no water saving. The rods failed to disperse sufficient film chemical to the water to create and maintain a compressed film. Failure of the emulsion 54 to provide water saving initiated further laboratory tests and basic film-dispersion studies on other solid emulsions. Tables 2 to 4 present the findings on the rate of dispersion of different emulsions when placed on the water surface of a 3-acre pond at College Station, Texas. Specifically, the data of Table 2 reveals dispersion rates of rods of solid emulsion as a function of composition, whereas the data of Tables 3 and 4 demonstrate differences in dispersion rates as a function of both composition and two physical forms, rod and chunk, which are depicted by Figure 4.

For this investigation on dispersion rate, the following procedures for preparation and testing were used:

1. Emulsifiers, Aquasave SD-1, Mineral Oil, and "copper oleate"^{2/} were weighed out in a stainless steel beaker and heated to 60°C to form a homogeneous melt.
2. The melt was then poured slowly into the indicated weight of water, also at 60°C, with constant stirring (800 to 900 revolutions per minute) by a paint stirrer fitted into the chuck of a drill press.
3. The warm melt then was poured into molds to form the rods and into pans. After solidification of the emulsion, the mold exteriors were heated slightly to permit removal of the rods. Solidified emulsion in the pans was cut into chunks 1 by 1 by 1/4 inches. The ultimate rod form, Figure 4, consisted of 80 grams of solid emulsion molded around a 1/2-inch-diameter polyethylene tube float which was approximately 1 foot long.

^{1/} Aquasave No. 1-SD.....50 grams
Emulsifier No. 6097..... 1 gram
Emulsifier No. 6014..... 1 gram
Soap..... 1.5 grams
Mineral Oil..... 5 grams
Water.....15 grams

Aquasave No. 1-SD and emulsifiers 6097 and 6014 are products of Arista Industries Inc. of New York, New York.

^{2/} Ivory flakes were dissolved in warm water, 40 to 50°C, and a slight excess of powdered $\text{CuSO}_4 \cdot 7\text{H}_2\text{O}$ was added with constant stirring. The curd of "copper oleate" which formed was washed with water to remove excess CuSO_4 and residual Ivory flakes if present. The curds were then dewatered by suction filtering and air dried.

Table 2.--Rate of dispersion of some solid-rod emulsions

Emulsion no.	Composition ^{a/} (Parts by weight)			HLB ^{c/} no.	Days required for complete dispersion		Other observations	
	Arlacel ^{b/} no. amt.	Tween ^{b/} no. amt.	Mineral oil		Greater than	Less than		
^{d/} 151	85	3.000	-- --	15	^{e/} 1.8	30	--	
161	85	1.500	40 1.500	15	8.70	--	1	
161C	85	1.500	40 1.500	0	8.70	--	1	
168	83	1.000	20 .500	15	8.02	--	1	
168C	83	1.000	20 .500	0	8.02	4	--	
200	85	1.500	20 1.833	15	9.995	2	4	
201	83	1.590	20 1.500	15	10.004	4	--	3/4 gone--4 days
202	85	1.500	40 2.205	15	10.011	4	--	1/2 gone--4 days
203	83	1.500	40 1.686	15	10.007	2	4	
204	85	.750	20 3.414	15	14.018	4	--	1/2 gone--4 days
205	83	.750	20 2.910	15	14.035	2	4	
206	85	.750	40 5.76	15	14.013	4	--	1/2 gone--4 days
207	83	.750	40 5.01	15	14.053	4	--	1/4 gone--4 days
208	85	1.881	20 .75	15	6.047	2	4	
209	83	3.417	20 .75	15	6.040	2	4	
210	85	1.668	40 .75	15	6.078	2	4	
211	83	3.00	40 .75	15	6.080	--	1	
211	83	3.00	40 .75	15	6.080	1	2	
211A	83	3.00	40 .75	7.5	6.080	2	3	
211B	83	3.00	40 .75	3.75	6.080	2	3	
211C	83	3.00	40 .75	0	6.080	--	1	
212	20	5.85	20 .30	15	9.01	--	5 hours	
213	20	5.40	21 .60	15	9.07	3	--	Firm rod
214	40	5.70	40 .30	15	7.14	5 hours	1	
215	60	5.01	60 .75	15	6.03	5 hours	1	
216	60	2.16	61 .84	15	6.07	3	--	3/4 gone--3 days
217	80	3.93	80 .75	15	6.01	5 hours	1	
218	80	2.10	81 .90	15	6.01	3	--	1/2 gone--3 days
219	83	2.04	85 .96	15	6.04	5 hours	1	
220	83	2.37	80 .63	15	6.07	1	2	
221	83	1.89	81 1.11	15	6.03	3	--	Firm rod--3 days
222	85	1.62	85 1.38	15	6.03	3	--	Firm rod--3 days
223	85	2.04	80 .96	15	6.02	2	3	
224	85	1.44	81 1.56	15	6.03	3	--	Firm rod--3 days

^{a/} All rod formulations also contained 0.75 parts by weight of copper oleate, 150 parts by weight of Aquasave, and 45 parts by weight of water.

^{b/} Furnished through the courtesy of the Atlas Powder Company, Wilmington, Delaware.

^{c/} HLB (Hydrophile-Lipophile Balance) number system as developed by the Atlas Powder Company.

^{d/} Also contained 1.5 parts by weight of Ivory Soap Flakes.

^{e/} HLB values based only on the Arlacels and Tweens and does not include mineral oil contribution or the contribution of Ivory Soap Flakes to Emulsion No. 151.

Table 3.--Study of effect of some emulsifiers on rate of emulsion dispersion

Emulsion no.	Composition ^{a/} (parts by weight)				HLB no.	Estimated extent of dispersion (percent)		
	^{b/} 6097	^{b/} 60/106	^{b/} 6014	Mineral oil		6-1/2 hr.	24 hr.	48 hr.
^{c/} 250-R	2.49	0.51	--	15	6.04	25	75	--
251-R	--	.51	2.49	15	6.04	75	100	--
252-R	1.5	1.5	--	15	10	25	50	--
253-R	--	1.5	1.5	15	10	0	25	--
^{d/} 250-C	2.49	.51	--	15	6.04	75	>75	--
251-C	--	.51	2.49	15	6.04	75	100	--
252-C	1.5	1.5	--	15	10	50	75	--
253-C	--	1.5	1.5	15	10	25	75	--
251-R	--	.51	2.49	15	6.04	25	100	100
250-R	2.49	.51	--	--	6.04	25	75	100
251-R	--	.51	2.49	--	6.04	0	<25	25
250-R	2.49	.51	--	--	6.04	25	75	100
251-R	--	.51	2.49	--	6.04	0	25	25
252-R	1.5	1.5	--	--	10	0	0	25
253-R	--	1.5	1.5	--	10	0	0	25
251-C	--	.51	2.49	15	6.04	0	75	100
250-C	2.49	.51	--	--	6.04	0	>50	100
251-C	--	.51	2.49	--	6.04	0	25	75
252-C	1.5	1.5	--	--	10	0	50	>75
253-C	--	1.5	1.5	--	10	0	25	>50

^{a/} All emulsion formulations also contained 0.75 parts by weight of copper oleate, 150 parts by weight of Aquasave, and 45 parts by weight of water.

^{b/} These emulsifiers provided through the courtesy of the Arista Industries, New York, New York.

^{c/} R indicates emulsion in rod form.

^{d/} C indicates emulsion in chunk form--approximately 1-inch square by 1/4-inch thick.

Table 4.--Comparison of rates of dispersion of octadecanol from chunk forms of emulsion and rods of emulsion

Emulsion no.	Degree of dispersion	
	<u>5 hours</u>	<u>24 hours</u>
212 Rod ^{a/}	Rod intact	Gone
212 Chunk ^{b/}	Slight residue	Gone
214 Rod	Slight residue	Gone
214 Chunk	Gone	Gone
215 Rod	3/4 gone	Gone
215 Chunk	Slight residue	Gone
219 Rod	1/3 gone	Gone
219 Chunk	3/4 gone	Gone
	<u>6 hours</u>	
211 Rod	Gone	
211 Chunk	Gone	
211C Rod	Gone	
211C Chunk	Gone	

^{a/} Rods contained 80 grams of emulsion.

^{b/} Chunk packages contained 200 grams of emulsion.

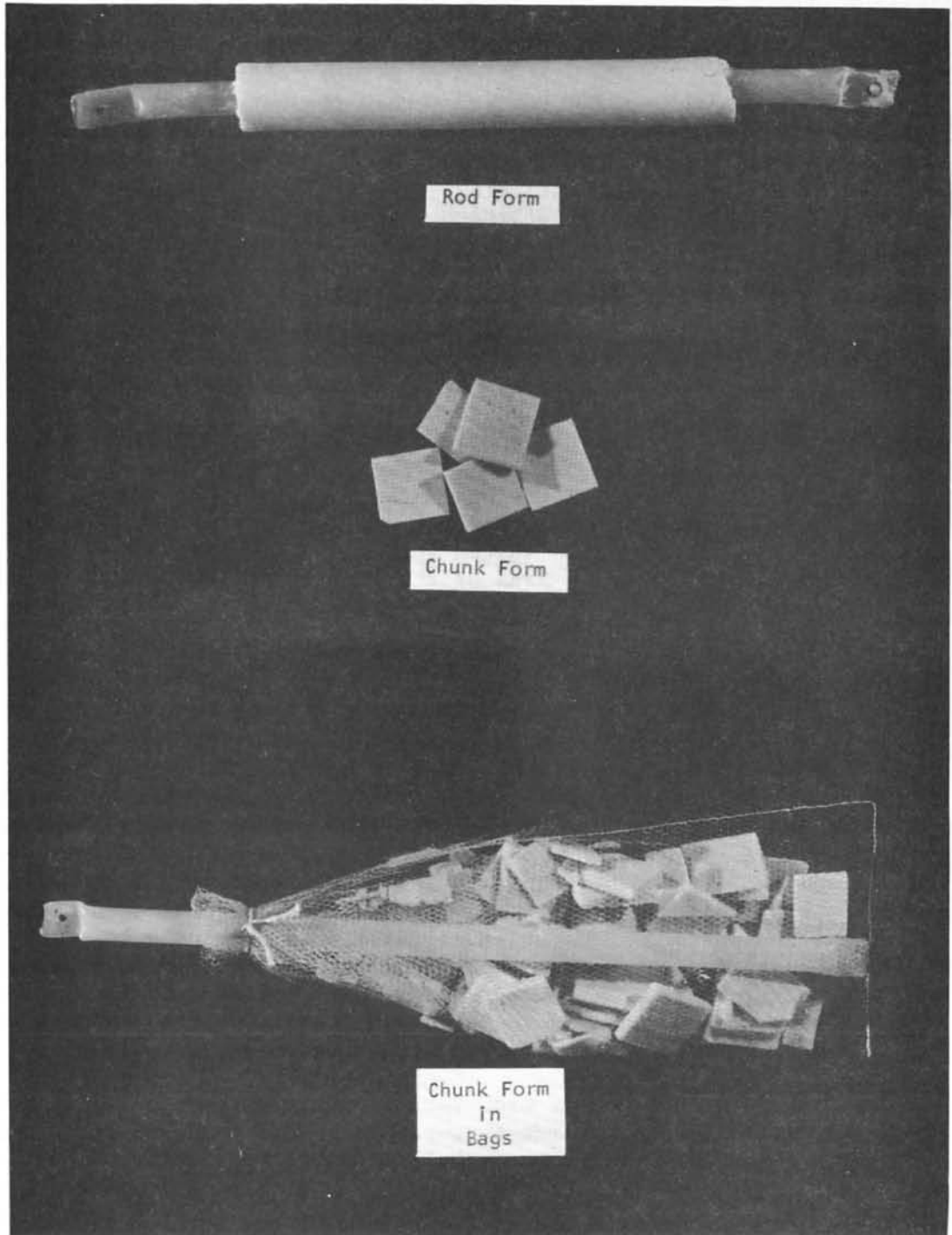

Rod Form

Chunk Form

Chunk Form
in
Bags

Figure 4
Forms of Solid Emulsion Tested

Texas Water Commission in cooperation with the Texas A & M Research Foundation

4. The emulsion preparations were then placed on the water surface near the prevailing upwind shoreline of a lake having approximately 3 acres of water surface. For these dispersion tests, both the rods (80 grams of emulsion), and chunks (200 grams of emulsion) were contained in a nylon mesh bag as shown in Figure 4. The bags of emulsions were tied at 6-foot intervals by 18-inch lengths of twine to a heavy cord stretched across the water surface. This set-up permitted free motion of the bags floating on the water surface--a motion created by the surface wind.

5. The time required for the different emulsion mixtures and forms to disperse on the water was noted. These time observations are recorded in Tables 2 through 4.

One of the merits of the rod-emulsion method for the application of chemical to the water surface was based on the premise that such a preparation would not continue to disperse chemical when a compressed film had been established--a fact which had been observed for pure forms of fatty alcohols. The premise was tested under field conditions and was found to be valid. Identical rods, prepared from emulsion formulation 161 (Table 2), were placed in natural pond water. One rod was placed on the open pond, approximately 2 to 3 acres in area, and one rod was placed in a tub approximately 3 square feet in area. The tub had a number of half-inch holes in the bottom and thus permitted water to enter. It was placed in a shallow area of the lake so that water rose to 4 inches from the top of the tub. In the confined 3-square-foot area of the tub, the rod rapidly produced a compressed film, whereas the rod on the open lake could not provide enough chemical to form a compressed film. Under these conditions the rod on the open lake dispersed in less than 1 day, whereas the rod in the tub retained its shape for 4 to 5 days. At the end of 7 days, the rod in the tub had disintegrated into large chunks.

The HLB (hydrophile-lipophile balance) system (Atlas Powder Co., 1961a, 1961b) was used as a basis for the preparation of the emulsions, and data of Table 2 show the preparation of emulsions with HLB numbers ranging from approximately 2 to 14. This HLB number range covers the upper level of the water-in-oil emulsifiers (HLB numbers 4 to 6), the transition or wetting agents (HLB numbers 7 to 9), and the oil-in-water emulsifiers (HLB numbers 8 to 18). In general, the data obtained show that poorest dispersion of film chemical was experienced with emulsions of HLB numbers from 10 to 14 and 6 or less. The greatest dispersion tendency seemed to be in the transition range from water-in-oil to oil-in-water emulsifiers, namely, HLB numbers of 7 to 9.

However, at a given HLB number wide variations in dispersion times were noted; it is evident that the balance between hydrophilic and hydrophobic groups of the emulsifiers employed is not the complete answer to the rate of dispersion of a fatty alcohol film chemical to the water surface. For example, emulsions 211, 212, 214, 215, 216, and 219 (Table 2), prepared with different emulsifiers to give an HLB number around 6, gave rapid dispersion; whereas emulsions 208 to 210, 216, 218, and 221 to 224, also with HLB numbers around 6 and prepared with other emulsion combinations, produced rods of poor dispersion quality. Similar observations may be noted for the emulsions of Table 3 which were prepared with emulsions obtained from another industrial source. Constituents of the emulsion other than the emulsifiers also may influence dispersion rates. Emulsion 211C which contained no mineral oil dispersed more rapidly than did 211B, 211A, and

211 which contained 3.75, 7.5, and 15 parts by weight of mineral oil, respectively. The reverse effect of mineral oil was noted with emulsion 168; that is, dispersion was rapid with mineral oil present and very slow in the absence of mineral oil. Table 2 shows that mineral oil has no effect upon the dispersion rate of emulsion 161.

Also, the data of Table 2 suggest the feasibility of "tailoring" an emulsion to the dispersion rate desired. Preparation 151 with a dispersion time in excess of 30 days and preparation 212 with a dispersion time of less than 5 hours represent the extremes obtained. Likewise, difference in physical form of the solid emulsion, rod or chunk, alters the rate of dispersion to the surface of a body of water. Table 4 demonstrates that dispersion rate is a function of surface area exposed by the emulsion. For a given emulsion, chunks provided a greater surface area than rod formulations and therefore dispersed more rapidly.

The function of the nylon bag shown in Figure 4, especially with chunk formulations, is to prevent large solid particles of emulsion from being blown across the water surface. The selection of material for the bag is of prime importance. Bags prepared from old nylon hose or nylon net of approximately 1/8-inch hexagonal mesh, for instance, afforded no barrier to dispersion. Dispensers made of hardware cloth, also of 1/8-inch material and fitted with adequate floats, did nothing to withhold dispersion. Those prepared from cheese cloth or surgical gauze, however, greatly reduced dispersion rates. The cotton cheese cloth and gauze stretched when wet by the water, so that their mesh openings were almost sealed.

Emulsion 211C was selected for later field study on the twin-pond test facility in Throckmorton County. Selection was based on the desirable physical hardness of the emulsion, the absence of mineral oil which would add to the cost of the emulsion, and the rapid dispersion potential. Preparation 161C also could have been used. Results of the twin-pond tests are presented in the field tests section of this report.

Evaporation and Evaporation-Control Studies with Small Field Test Pans

Data of this section provide an insight to a number of factors relating to the overall program; namely, evaporation control by film chemical and several solid plastic preparations, evaporation control as a function of depth of water, evaporation control as a function of wind travel over pans of different height above ground, evaporation control as a function of the method of application of film chemical, and the influence of the cleanliness of the water on evaporation control.

In the initial approach of this series of tests, aluminum drums were sawed in half to produce containers approximately 17-1/2 inches deep by 22-7/16 inches inside diameter. Six of the vessels were supported in a 2 x 4 framework in an open field so that the water surface in each drum would be the same distance from the ground--approximately 24 inches. The containers were filled with tap water to a depth of 17 inches. All water surfaces were subjected to the same environmental conditions of sun, wind, and rain.

The 2.77 square feet of water surface exposed in the containers was then treated with different preparations of Aquasave 1-SD; namely, a solution in hexane, a solution in 99 percent isopropanol, and solid emulsion in the form of a rod 1 inch in diameter and 2 inches long cast around a polyethylene float. Tanks 3 and 5 also were treated with 10 parts per million of Terramycin activity, based on water volume, as supplied by a crude preparation of Terramycin. The level of water was established by a hook gauge fixed to the side of the tank, and the amount of water evaporated over a given period of time was determined by measuring the volume of water required to refill the tanks to the starting level. Details of solution additions and results are recorded on Table 5.

The tanks were emptied and washed after this experiment and filled to a depth of 17 inches with water taken from the country club lake. Aquasave 1-SD was added daily to tanks 4, 5, and 6 as 5 ml of a solution in isopropanol. Tank 2 was treated with a small rod of emulsion as used in the previous experiment. Tank 3 was treated with an emulsion of the same formulation containing 0.25 parts by weight of copper oleate. Tank 1 served as a control and received no film chemical. Furthermore, the rod emulsion was retained on the water for the duration of the test. Details of the results are provided in Table 6.

Data provided in Table 5 show that water saving approached 50 percent when adequate film chemical was applied and existing maximum air temperatures ranged from 95 to 100°F. The rod emulsions on Tank 2 provided adequate film coverage and an average water saving of 47.5 percent. The control or untreated water, Tank 1, lost an average of 2,490 milliliters (approximately 0.66 gallons) of water per day from the 2.77 square feet of water surface over the 21-day test period. A total of 0.79 feet of water was lost from the control tank in 21 days, or 0.79 acre-feet of water per acre of water surface. The rod emulsion reduced this loss by approximately 50 percent.

Adequate film chemical was not provided by the addition of a total of 80 to 500 mg (milligrams) of Aquasave per week as a solution in isopropanol and hexane in Tanks 4 and 6--the solutions were added to supply 40 and 250 mg of Aquasave on only 2 days of the test period. However, the addition of 500 mg of Aquasave as a solution twice per week provided adequate or excess film chemical to afford a water saving approaching 50 percent. These data demonstrate that adequate film chemical may be provided by an emulsion or as a solution in a polar or nonpolar solvent to create a film on the water surface capable of producing significant water saving.

Tanks 3 and 5 (Table 5) were supplemented with the antibiotic Terramycin in an attempt to suppress bacterial life in the test water and thereby decrease the potential utilization or destruction of film chemical by bacteria. This approach was not successful, mainly because the antibiotic is rapidly destroyed in aqueous media. More frequent addition of the antibiotic would be required. Also, the antibiotic was a crude preparation which afforded a great deal of nutrient for microbial growth and imparted a dark brown color to the water--a factor which would increase the temperature of the water. This approach, to determine the influence of bacteria on film-chemical requirements, needs further investigation. As will be noted later, however, the residence time of the film on the surface of the water is relatively short on small ponds or lakes. Therefore, microbial life is of little or no importance in determining the quantity of film chemical needed to maintain a compressed film. Rather, nonpathogenic microbial forms of life may be pointed to as desirable scavengers of the excess film chemical that collects at downwind shorelines.

Table 5.--Small-tank studies on methods of aquasave application

Date	Evaporation from control, tank 1 (ml)	Percent water saved				
		Rod emulsion ^{a/}		Isopropanol solution		Hexane solution
		Tank 2	Tank 3 ^{b/}	Tank 4	Tank 5 ^{b/}	Tank 6
7/21-7/25	7,310	55.7	36.0	2.4	2.7	0
7/25-7/28	7,680	42.0	32.4	(31.6) ^{c/}	0	12.6
7/28-8/1	9,920	47.9	26.0	4.0	0	19.5
8/ 1-8/4	7,480	58.3	36.7	2.5	1.8	13.7
8/ 4-8/8	9,800	49.1	30.6	46.1	(8.4) ^{c/}	43.0
8/ 8-8/11	4,860	33.3	33.3	50.0	56.1	50.0
8/11-8/25	5,265	46.3	30.7	49.8	38.5	49.8

^{a/} Rod emulsion ingredients, in grams: aquasave-50, mineral oil-5, water-15, Ivory soap-1.5, stabilizer 6097 (Arista Industries, Inc.)-1.0, and stabilizer 6014 (Arista Industries, Inc.)-1.0.

^{b/} Ten parts per million Terramycin activity (based on water volume) added as a crude preparation on 7/21 and 7/25.

^{c/} Data questionable.

Table 6.--Water savings as obtained by rod emulsions and isopropanol solutions of Aquasave 1-SD in small tanks

Date	Water loss (ml)	Water savings ^{a/} in percent				
		Tank 1	Tank 2	Tank 3	Tank 4	Tank 5
8/19-8/26	12,260	29.2	33.4	32.7	49.0	50.8
8/26-9/ 2	12,610	45.8	47.7	45.1	51.9	52.3
				Aquasave Additions Stopped		
9/ 2-9/ 9	14,540	56.6	57.7	16.4	20.9	45.8
9/ 9-9/16	15,970	53.9	51.5	.6	4.1	35.6
9/16-9/23	15,680	45.8	39.6	1.2	2.0	2.2

Tank Treatments:

No. 1, Control--no film chemical.

No. 2, Rod Emulsion--formulation as per Table 5.

No. 3, Rod Emulsion--formulation as per Table 5 plus 0.25 grams copper oleate.

No. 4, Daily addition of 50 mg. Aquasave 1-SD as 5 ml of solution in 99 percent isopropanol.

No. 5, As per No. 4 but 100 mg. of Aquasave daily.

No. 6, As per No. 4 but 200 mg. of Aquasave daily.

$$a/ \left(\frac{\text{Control evaporation} - \text{test evaporation}}{\text{control evaporation}} \right) \times 100 = \text{Percent.}$$

Findings in Table 6 support the previous results of Table 5; that is, water saving of 50 percent may be obtained by an evaporation retardant such as a 50:50 mixture of hexa- and octadecanol when it is supplied as an emulsion or a solution in organic solvent. The studies with isopropanol solutions, Tanks 4, 5, and 6, point to the need for the daily addition of approximately 50 mg of the film chemical to provide the 50 percent water saving. The marginal aspect of this quantity of material is demonstrated by the sharp drop in water saving when solution addition was stopped. Greater water saving was demonstrated by the residual Aquasave remaining in Tanks 5 and 6 after discontinuation of addition of film chemical following 14 days of the daily addition of 100 and 200 mg of Aquasave, respectively. However, even with the 200 mg daily addition for 14 days there was essentially no water saved after 3 weeks.

Direct calculations from the volume of water lost from the control or untreated water surface of Tank 1 provide a figure of 0.91 feet for the water lost in 35 days. The realization of a 50 percent water saving by the addition of film chemical would reduce the figure to 0.455 feet; for a 1-acre pond this would be equivalent to the saving of in excess of 4,240 gallons of water per day--a volume of water sufficient for more than 400 head of cattle.

Table 7 presents a summary of evaporation rates from cylindrical aluminum vessels exposing 2.77 square feet of water surface when filled with water, as influenced by depth of water, cleanliness of the water, wind travel over the water surfaces at different heights from the ground, and by evaporation retardants--an emulsion of Aquasave and 1-inch-diameter white plastic balls. All tanks were supported in a level portion on 2 x 4 footings. The support was such that water surface in the tanks containing 7, 17, and 27 inches of water were 10, 20, and 30 inches from ground level, respectively. Wind-velocity readings, used to obtain the wind ratios of Table 7, were taken with small anemometers placed on slats of wood across the tanks. The center of the anemometer vane was located approximately 12, 22, and 32 inches above ground level, respectively. For the wind ratios, the wind travel over the shortest tank (No. 1) was taken as the standard. That is, wind travel over the taller vessels divided by the wind travel over the short container provided the indicated wind ratios for the taller units. Evaporation ratios presented by Table 7 likewise use the volume of water evaporated from the shallowest container as a basis for comparison. These data may be summarized as follows:

1. Daily evaporation rates increase as the surface of the water is progressively raised above ground level--at least in the height range presented by Tanks 1, 2, and 3.
2. Part of this increase in the evaporation rate with elevation of water surface is due to wind travel which increases with height from the ground. This fact is borne out by the ratios of wind travel over the three heights of tanks. These ratios varied from the average presented, but the order was always the same. Higher wind velocities tend to augment the spread in the wind-travel ratios.
3. Cleanliness of water seemed to have little effect upon evaporation rates--at least under the test conditions employed. Tanks 6 and 7, which had been used as controls in a previous experiment, contained a heavy growth of algae and the water was brown in color whereas Tanks 3 and 4, of the same depth, contained clean tap water when the experiment was initiated. On an average, the daily evaporation obtained with the dirty water was 132 ml greater than obtained

Table 7.--Some factors relating to small-tank evaporation-control studies

Tank no.	1	2	3	4	5	6	7
Water	Clean	Clean	Clean	Clean	Clean	Dirty ^{c/}	Dirty ^{c/}
Treatment	None	None	None	Emulsion ^{a/}	Balls ^{b/}	None	Emulsion ^{a/}
Water depth (inches)	7	17	27	17	17	17	17
Water evaporated (ml)							
Date							
5/ 3-5/ 4	1,580	1,700	1,540	600	300	1,900	670
5/ 4-5/ 5	1,600	2,170	2,390	980	700	2,330	980
5/ 5-5/ 6	1,000	1,470	1,790	5.0	270	1,780	520
5/ 6-5/ 9	5,440	6,720	7,270	2,850	1,670	7,000	3,000
5/ 9-5/10	1,620	2,000	2,490	820	920	2,550	900
5/10-5/11	2,000	2,820	3,480	1,080	570	2,940	1,090
5/11-5/12	2,000	2,800	3,000	1,170	810	2,800	1,190
5/12-5/17	10,190	12,270	13,790	4,760	3,780	12,520	5,200
Total	25,510	31,950	35,750	12,770	9,020	33,800	13,350
Daily Average	1,822	2,282	2,554	912	644	2,414	954
Wind-travel ratios ^{d/} over water surface (tank no. 1 as the standard)	1.0	1.22	1.47	1.22	1.22	1.22	1.22
Evaporation ratios ^{d/} (tank no. 1 as the standard)	1.0	1.26	1.42	.50	.35	1.32	.52

^{a/} Emulsion 211C--see Table 2.

^{b/} 1-inch-diameter hollow plastic balls.

^{c/} Water contained heavy algal growth.

^{d/} 7-inch water depths as standard or 1.0.

with clean water, and as such represented a 5.8 percent increase in water evaporation. This was probably owing to greater heat absorption by the dirty water.

4. Extensive water saving was obtained on both clean and dirty water by emulsion preparation 211C of Table 2. On an average, 60.0 and 60.5 percent water savings were obtained for the clean and dirty water, respectively.

5. The white hollow plastic balls used on Tank 5 provided an even greater water saving, 75.1 percent, based on Tank 2 (17-inch clean water container) as a control. The floating balls provided both a reflecting surface, to decrease heating by the sun's rays, and a barrier to the wind contact with the water surface.

Results obtained with a floating "monolayer" of fragments of a rigid polystyrene foam (Table 8) were similar to those obtained with the floating balls. However, the residence time of the foam on the water surface governed the nature of the results obtained. For example, the addition of 15 grams of foam particles which passed a No. 8 U. S. Standard sieve gave water savings of 38.8 and 27.5 percent in 2- and 3-day tests, respectively. The use of larger particles of foam, about 1/4-inch maximum width, gave a similar water saving, 35.8 percent, when based on a 3-day test period. However, a review of the data shows that this was merely an average of 2 days (October 4 to 5 and October 5 to 6) of essentially 50 percent water saving followed by a third day of only 5 percent saving. The reason for these results became apparent upon visual observation of foam in the tank during the third day of the test. For 2 days the foam floated "on" the surface of the water and by the third day the air pores of the foam had filled with water and the foam floated just "under" the surface of the water. In this position the foam no longer served as a wind barrier and the water vapor adjacent to the water surface was readily removed by the prevailing wind. In the absence of wind, a "stagnant" layer of water vapor persists near the water surface and decreases the rate of evaporation from the water surface. It seems from the data provided by Tables 7 and 8 that both the plastic balls and foam fragments, at least in part, served to prevent the removal of the stagnant layer by the wind.

Use of the plastic balls at \$6.00 per 1,000 would be prohibitive for an evaporation-control program. The foam-fragment concept would have merit if effective evaporation control residence time of the foam could be increased. An approach to enhancing residence time of the foam "on" the water surface would be to use a "closed cell" substance instead of an "open cell" structure represented by the foam fragments used in this investigation. An "open cell" foam may be considered as one having numerous open air passages that are readily filled with water. In contrast, a "closed cell" material may be visualized as numerous bubbles of air held together by plastic--in essence a great number of balls held together by plastic binder. In the "closed cell" foam, as visualized above, water could not displace the air and a floating "monolayer" possibly could be retained for extended periods. The barrier of rigid foam could be attractive for reducing evaporation on deep ponds of small surface area. This approach to water-evaporation control merits further investigation--especially in reference to screening other rigid plastic foams for "residence" or "floating" time and field tests on fractional-acreage ponds. The coarse scrap foam used in the above investigation, selling at 10 cents per pound, would represent an investment of \$120 per acre--a cost that would not be prohibitive if the foam would last for an extended period--1 year for example.

Table 8.--Rigid foam particles as evaporation retardants

Test period (dates)	Test duration (hours)	Control evaporation in Tank no. 1 (ml)	Water saved (percent)	
			Tank no. 2, emulsion ^{a/} treated	Tank no. 3, foam ^{b/ c/} treated
9/27- 9/29	53.0	4,000	40.3	38.8
10/ 1-10/4	72.0	5,640	48.4	27.5
10/ 4-10/5	27.5	2,000	33.0	50.5
10/ 5-10/6	22.5	1,820	48.9	48.2
10/ 6-10/7	28.0	1,550	27.5	5.2
10/ 4-10/7 (combined)	78.0	5,370	38.4	35.8

^{a/} Emulsion 211C--see Table 2.

^{b/} Foam particles which passed No. 8 U. S. Standard sieve were used in the test of 9/27-9/29 and 10/1-10/4. Fifteen (15) grams were used per 2.77 square feet of water surface.

Foam particles retained on No. 4 U. S. Standard sieve were used in runs of 10/4-10/7. Thirty-five (35) grams were used per 2.77 square feet of water surface.

^{c/} Foam milling scrap furnished by MMM, Inc., Houston, Texas.

The data provided in Table 9 demonstrate a wide divergence in evaporation rates from metal containers, which are similar in concept to evaporation pans commonly used in securing evaporation data. Tanks 1 to 4, inclusive, were buried in the ground so that the water level in the tanks was essentially at ground level, whereas in Tanks 5 to 8 the water surfaces were 10, 20, 20, and 30 inches above ground level, respectively. The three control buried tanks exhibited an average daily evaporation of 2,600 ml of water over a 31-day test period. In comparison, evaporation rates from Tanks 5, 6 and 8, where the water levels were 10, 20, and 30 inches from ground level, were 2,800, 3,344 and 3,338 ml, respectively.

These data are in keeping with results of Table 7 where it was shown that wind travel over a water surface increases as height of water level above the ground is increased. Active percent water savings realized with an emulsion of Aquasave were almost the same for the buried control and test tanks (Tanks 2 and 3) as for the surface system (Tanks 5 and 6). Percent savings, based on control evaporation as zero, were 49.7 and 51.9, respectively, for the buried and surface tanks. However, it may be noted that the actual gallons of water lost for the 31-day test period by the surface-tank control was 26.5 percent greater than the volume of water lost by the buried control. Similarly, there was a 21.4 greater loss of water from the elevated film-treated surface tank than from the buried film-treated tank. Thus, it is apparent that wind travel over the water surface is an important factor both in total water evaporation and in the water saving that may be realized with a chemical film.

Evaporation-Control Investigations Under Controlled-Environment Conditions

Data presented for the small-tank studies indicate water savings of 40 to 50 percent by the application of a film provided by a mixture of hexa- and octadecanol--applied either as a solid emulsion or as a solution in organic solvents. Certain of the data suggest that water savings expressed as percent do not necessarily have the same significance as gallons of water saved per unit of water surface in determining the economics of an evaporation-control system.

Research results presented in Tables 10 and 11 were provided by an investigation designed to demonstrate, under ideal conditions, the effects of wind travel, relative humidity, temperature, and pond depth on the ultimate economics (film-chemical cost per 1,000 gallons of water saved) of an evaporation-control program.

Figure 5 shows two evaporation setups employing a "controlled-environment chamber" designed and used by Dr. Morris E. Bloodworth, Head of the Department of Soil and Crop Sciences at Texas A & M University, for his studies on the water requirements of plants. The basic "controlled-environment chamber," 4 by 4 by 10 feet, was constructed of 5/16-inch plastic and was housed in a constant-temperature room. The chamber was instrumented and equipped to permit control of the temperature, relative humidity, and air-flow conditions within the chamber. For the water-evaporation studies, an auxiliary wind tunnel or duct was placed within the plastic chamber as shown in Figure 5. The auxiliary duct consisted of a fan, located at the air-intake end of the duct and used to regulate the rate of airflow over water containers, an 18-mesh screen to provide for an even flow of air over the containers, and an air-discharge duct section housing the water containers.

Table 11.--Evaporation studies in controlled-environment chamber with deep cans

Wind Velocity (mph)	Water evaporated (gallons per acre per day ^{b)})		Water saved		Cost ^{e)} per 1,000 gallons water saved (cents)
	Control	Test ^{a)}	Gallons ^{c)}	Percent ^{d)}	
100°F--60 Percent Relative Humidity					
2	3,150	2,350	800	25.4	60.0
4	5,500	3,350	2,150	39.9	44.5
6	6,800	4,300	2,500	36.7	57.5
8	7,950	5,200	2,750	34.7	69.8
10	9,100	6,150	2,950	32.9	81.3
12	10,300	7,100	3,200	31.1	90.0
100°F--40 Percent Relative Humidity					
2	7,000	3,350	3,650	52.2	13.1
4	13,250	6,350	6,900	52.3	13.9
6	18,150	8,850	9,300	51.2	15.5
8	21,400	10,400	11,000	51.3	17.4
10	23,250	11,500	11,750	50.5	20.4
12	24,500	12,600	11,900	48.5	24.1
100°F--20 Percent Relative Humidity					
2	14,550	8,850	5,700	39.1	8.4
4	22,600	13,500	9,100	40.3	10.5
6	28,850	16,200	12,650	43.8	11.4
8	31,800	18,600	13,200	41.5	14.5
10	33,200	20,600	12,600	37.9	19.0
12	33,900	22,600	11,300	33.3	25.4
45°F--60 Percent Relative Humidity					
2	7,000	4,250	2,750	39.3	17.4
4	11,150	5,800	5,350	47.9	18.0
6	13,200	6,400	6,800	51.5	21.2
8	15,200	6,700	8,500	55.8	22.5
10	17,150	7,700	9,450	55.2	25.3
12	19,200	8,250	10,750	55.8	26.7

^{a)} Film chemical used on test cans supplied by 1/8-inch chunks of a 50:50 mixture of hexa- and octadecanol contained in a screen mesh container fixed to the upwind edge of the can.

^{b)} Calculated from experimental data.

^{c)} Water evaporated from control cans minus water evaporated from test cans.

^{d)} Gallons water saved times 100 divided by water evaporated from control cans.

^{e)} Based on film chemical at 48 cents per pound.

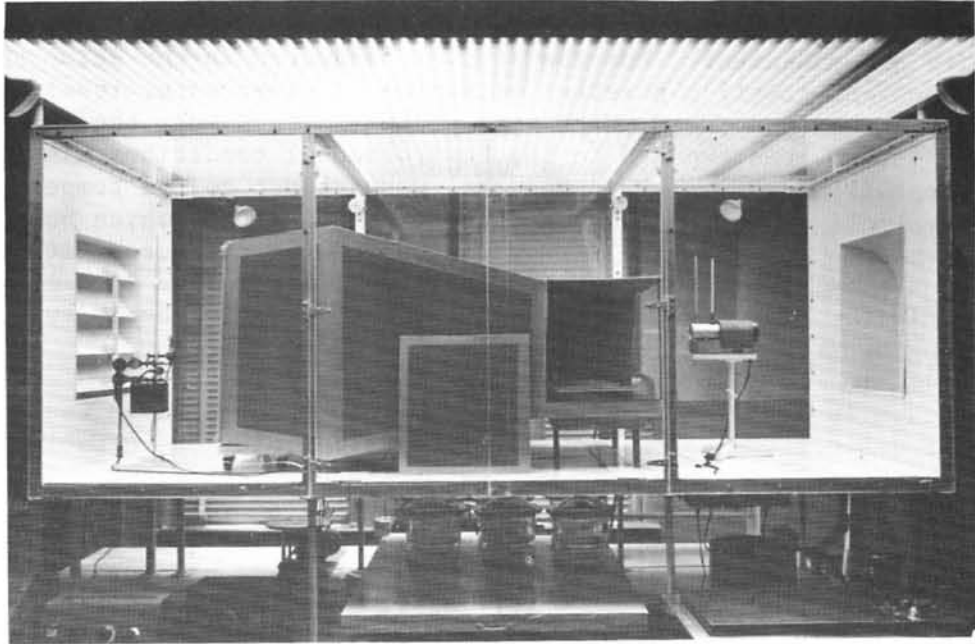

A. Evaporation Studies with Pans

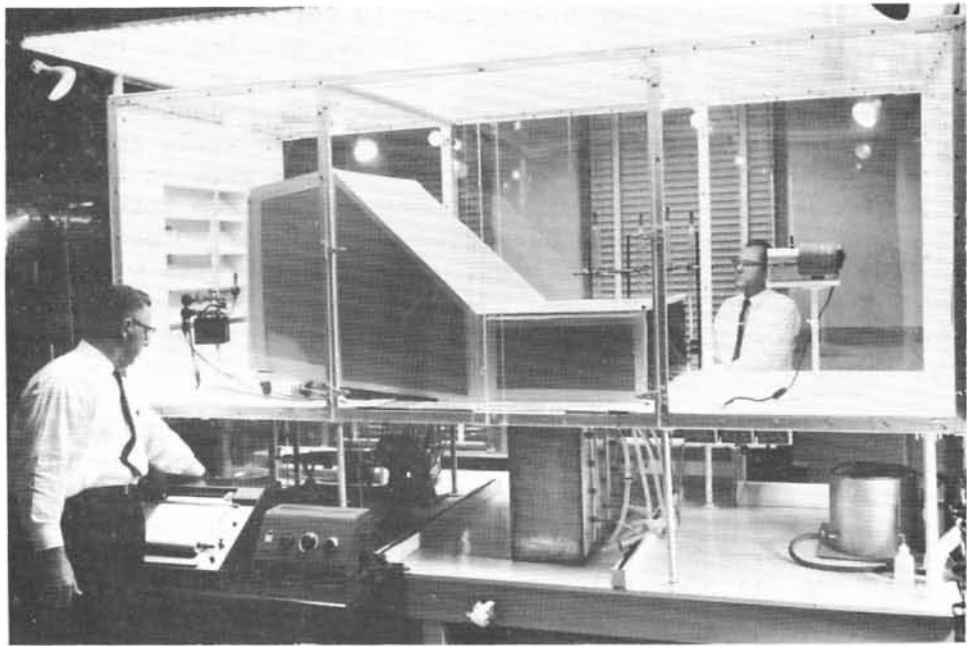

B. Evaporation Studies with Cans

Figure 5

Controlled-Environment-Chamber Setups:

Texas Water Commission in cooperation with the Texas A & M Research Foundation

In studies employing the setup shown by Figure 5A, the water containers were shallow pans which had an exposed water-surface area of 75.25 square inches. Under test conditions, the pans and the entire volume of water contained in them were subjected to the heating or cooling effect of the air being supplied to the air-duct within the chamber. For the studies conducted in the setup shown by Figure 5B, constant-leveling burettes maintained a given water level in cans which were 23 inches deep, and which were placed so that only the water surface, 75.25 square inches, was exposed to the environmental conditions within the chamber. The bulk of the water in the cans was subject to the temperature conditions, essentially 75°F, of the constant-temperature room which housed the "controlled-environment chamber." Evaporation studies conducted with these two experimental setups included variations in wind velocity from 2 to 12 miles per hour, air humidities ranging from 20 to 60 percent relative humidity, and temperatures ranging from 45 to 100°F.

Evaporation losses at zero wind velocity were determined in sealed, 10-inch-diameter desiccators containing saturated salt solutions capable of maintaining different relative humidity levels within the desiccator. The saturated salt solutions were contained in the bottom of the desiccator, and the water for evaporation was contained in a petri dish on the desiccation plate above the saturated salt solutions. Desiccators and contents were placed in the constant-temperature chamber for 24 hours. Water losses from both untreated (control) and film-treated waters were determined by weighing the dishes both before and after the 24-hour evaporation period.

The data of Table 10, obtained with shallow pans, should be applicable to shallow farm or ranch ponds which are subject to thermal change by the climatic conditions existing above the pond water, that is, heating in the summer and cooling in the winter. On the other hand, data presented in Table 11 should be more typical of deep ponds which are essentially independent of temperature changes caused by climatic conditions. The deep ponds would tend to remain cool in reference to the air temperature in the summer and warm in the winter. In the shallow-pan setup, the volume of water evaporated from both the control and test pans decreased as temperature decreased when air of 60 percent relative humidity was blown over the pan surfaces. However, in tests with the deep cans (data of Table 11) the actual gallons of water evaporated increased as temperature decreased for both the control and test cans under the same conditions of air humidity; namely, 60 percent relative humidity.

At a given temperature, 100°F (Table 11), a decrease in relative humidity of the air passing over the water in the cans caused an increase in the volumes of water evaporated from both the control and test cans. Other data obtained showed that a similar relationship existed at 100°F in the pan studies; namely, at a wind velocity approaching 3 miles per hour, the control evaporations were equivalent to 14,100, 11,800, and 8,000 gallons per day per acre, respectively, for 20, 40, and 60 percent relative humidities. Corresponding chemical-film-test evaporations were equivalent to 7,800, 6,600, and 4,600 gallons per acre per day.

As indicated by the data of Tables 10 and 11, the volumes of water evaporated are increased by an increase in the wind velocity. Also, the volume of water evaporated from the control is always greater than that for the corresponding test container. At zero wind velocity (Table 10), the volumes of water evaporated were small and the difference between the volumes of water evaporated

from the control and the test also were small. These results are explainable on the basis of the "stagnant water-vapor film" which exists above a water surface during periods of calm. This moisture vapor film hovers near the surface of the water and thus forms a barrier against the further escape of water molecules from the liquid water phase to the atmosphere above the water. Apparently the limiting rate is the diffusion of the water molecules to the atmosphere and not the escape of the water molecules from the water surface. This is true even when a film chemical is added because essentially the same volume of water is evaporated both from the untreated water and the water treated with a chemical film. However, as the wind velocity increases from calm conditions, the stagnant-vapor film is removed; therefore, the importance of the barrier against the escape of water molecules from the water surface created by the added chemical film becomes more apparent because the rate of escape of water molecules from the film treated water surface is much smaller than from the untreated water surface.

Water saved by the application of a chemical film to the surface is expressed in two ways in Tables 10 and 11, as gallons of water saved per acre per day, and as percent. Of these two, the volume of water saved per unit of water area is the most desirable because it permits an approach to the actual cost involved in saving a given unit volume of water. Likewise, Tables 10 and 11 are important in evaluating water-savings data obtained in field studies where one pond is used as a control and another pond is treated with a film--a situation which is represented by the "twin pond" test site which is described later in this report. As an example from the data of Table 11, at 100°F and 60 percent relative humidity, with a 2 mph wind the control evaporation was 3,150 gallons and at 4 mph the film-treated (test) evaporation was essentially the same--3,350 gallons. Now let us assume that these wind conditions existed in field studies--2 mph on the control pond and 4 mph on the test pond. Based on these data there was an actual loss of 200 gallons more from the test pond than from the control pond. But if all conditions had been equal--including a 4 mph wind on the control pond--there would have been a saving of 2,150 gallons of water per day. Graphical representations of these data, Figures 6, 7, and 8, demonstrate a break in evaporation rates in the region of 0 to 4 mph wind travel at the water surface. It is in this region that differences in wind travel on control and test ponds would have the greatest effect upon water saving. This concept is referred to again in the discussion of the data obtained from field tests on the "twin ponds."

The controlled-environment study also provided a basis for calculating the cost of film chemical for saving a unit volume, 1,000 gallons of water, under a variety of climatic conditions. Earlier in this presentation, it was shown by theoretical calculations that approximately 0.02 pounds of a 50:50 mixture of hexa- and octadecanol was required to cover 1 acre of water with a compressed film. Independent laboratory studies in conjunction with this investigation indicated the need for 0.05 pounds per acre. This value was calculated from laboratory data obtained by adding a dilute solution of Aquasave in hexane to a 120-square-inch water surface which had been dusted with a fine aluminum powder. As the film was formed, the powder on the water surface was forced toward the side of the pan. All of the powder was against the pan sides when a compressed film had been established. Converting the quantity of Aquasave added to the pan to a 1-acre basis disclosed the need for 0.05 pounds per acre of water surface--that is, 0.05 pounds per acre of water surface in the absence of any wind.

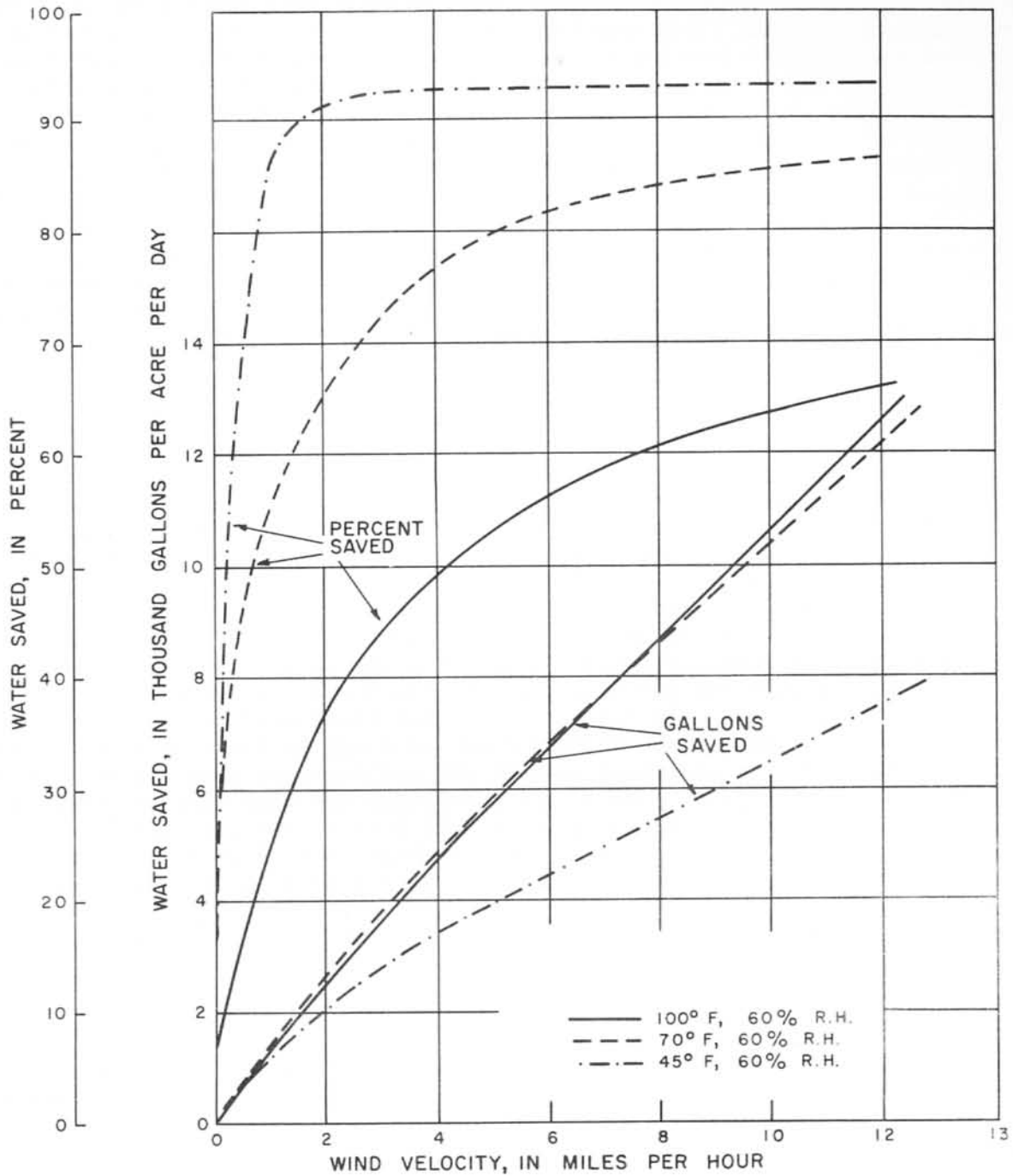

Figure 6
 Water Saved as a Function of Wind Velocity and Temperature at
 Constant Relative Humidity, Shallow-Pan Studies in
 Controlled-Environment Chamber

Texas Water Commission in cooperation with the Texas A & M Research Foundation

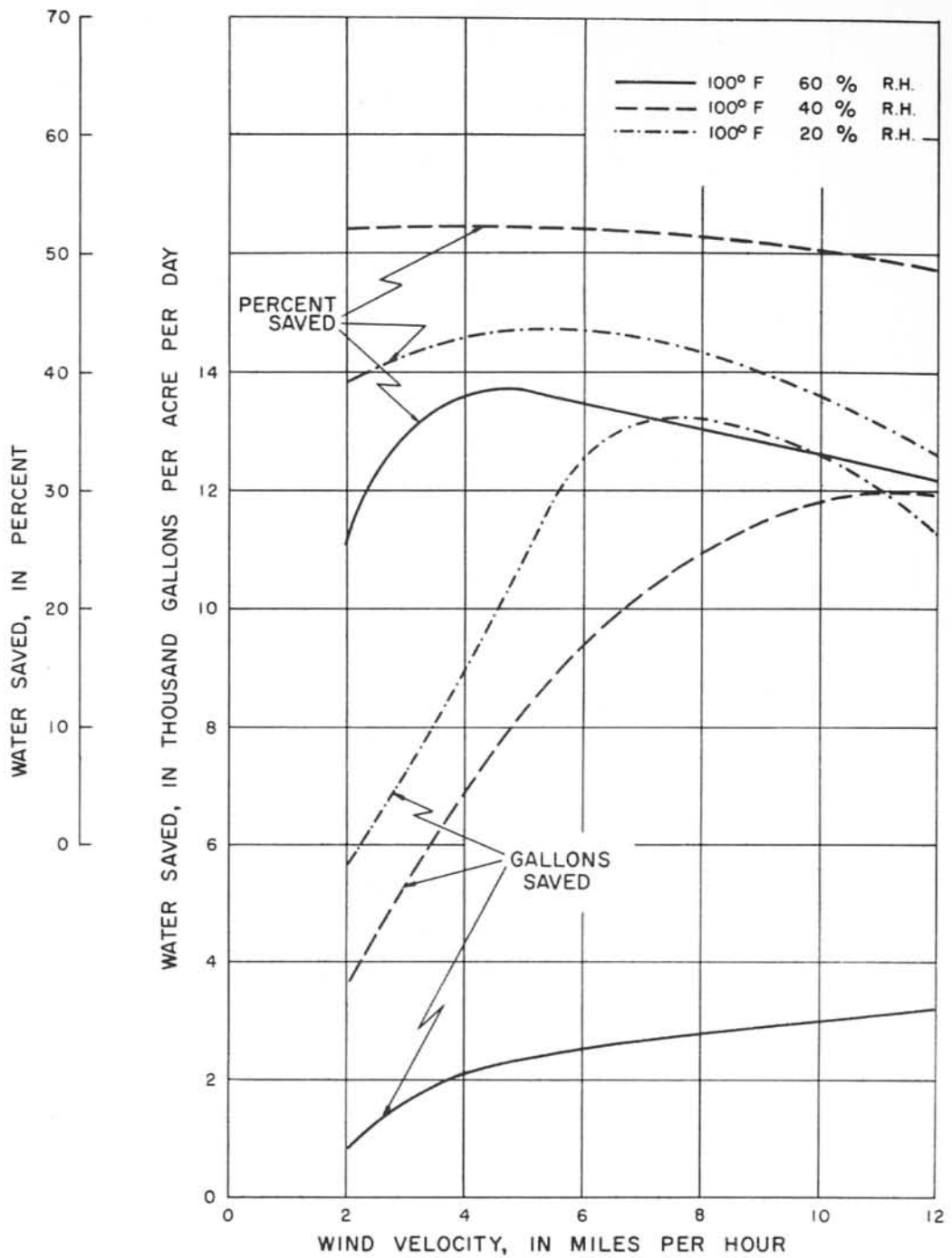

Figure 7

Water Saved as a Function of Wind Velocity and Relative Humidity
at Constant Temperature, Deep-Tank Studies in
Controlled-Environment Chamber

Texas Water Commission in cooperation with the Texas A & M Research Foundation

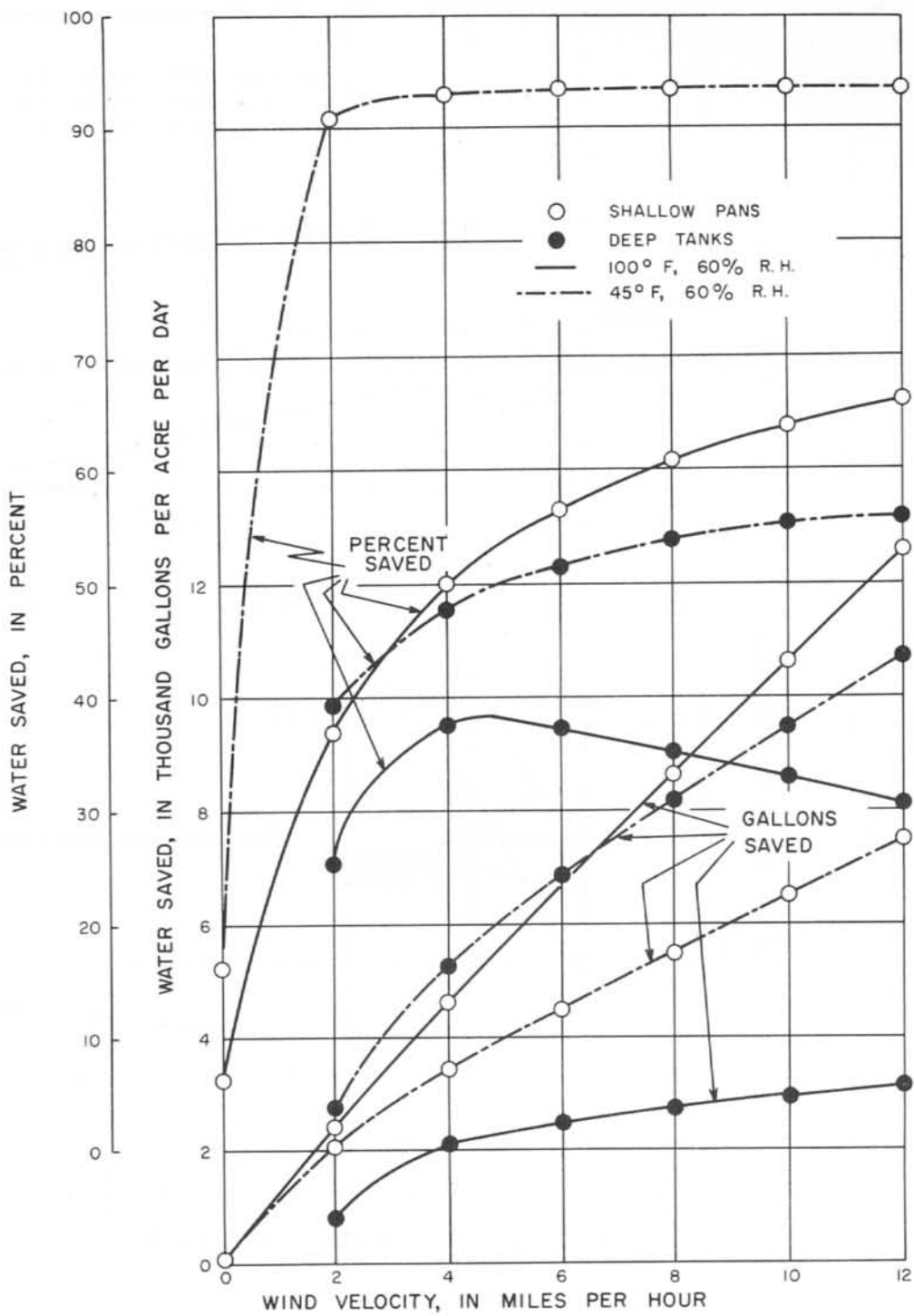

Figure 8
 Comparisons of Water Saved with Shallow Pans and with
 Deep Tanks in Controlled-Environment Chamber
 Texas Water Commission in cooperation with the Texas A & M Research Foundation

A film will travel 3.4 feet for each 100 feet of surface wind travel--or film travel is 3.4 percent of surface wind travel--as shown in a later section of this report. Thus with a 1 mile (5,280 feet) per hour wind, a chemical film on a water surface would move 179.5 feet per hour. With such film travel over a 24-hour period, on a pond 100 feet wide normal to the wind, the total theoretical water-surface area covered by the film would be essentially 10 acres (179.5 x 24 x 100/43,560). To provide a film cover for this 10 acres of water surface would require 0.5 pounds of chemical. This is based on the experimental figure of 0.05 pounds of film chemical per acre rather than the 0.02 pound theoretical figure. At current prices of 48 cents per pound, the 0.5 pounds of film chemical would cost 24 cents. This quantity of film chemical, on a theoretical basis, would be required by any pond up to 10 acres in water-surface area as long as each of the ponds exposed 100 feet of shoreline normal to the prevailing wind. Also, for each increase of wind travel of 1 mile per hour there would be a corresponding increase in film-chemical requirement of 0.5 pounds. Furthermore, the film chemical is released at a rate to keep a continuous film on the water surface at all times. The cost figures presented by Tables 10 and 11 are for such conditions for a 1-acre pond--100 feet of shoreline normal to the wind travel by 435.6 feet in downwind length--and assumes no recirculation or reuse of the film chemical once it has traversed the water to the downwind shoreline.

Indicated costs of film chemical for saving 1,000 gallons of water, based on the deep-can investigations, range from a minimum of 8.4 cents at 100°F, 40 percent relative humidity, and a wind travel of 2 miles per hour to a maximum of 90.0 cents at 100°F, 60 percent relative humidity, and 12 mph wind. The variation between calculated minimum and maximum costs from the shallow-pan data was less, namely, 18.4 cents as a minimum and 38.3 cents as a maximum. In general, a cost of about 20 cents per 1,000 gallons of water saved would represent a good average and is in keeping with a similar figure range, 10 to 20 cents per 1,000 gallons of water, quoted in a recent American Water Works Association report (Michel, 1962). The 20-cent cost would not apply under conditions where hot humid air (100°F and 60 percent relative humidity) contacts a cool water surface or where a cool humid air (45°F and 60 percent relative humidity) contacts a warm body of water.

The above costs, as stated before, are for a particular 1-acre body of water that exposes 100 feet of shoreline to the prevailing wind and is 435.6 feet long in the downwind direction. It is well to note at this point that the above costs would be approximately doubled if the pond length in the downwind direction were reduced by one-half. That is, the same amount of chemical would be required by the 100 feet of shoreline normal to the wind but the actual gallons of water saved would be less--essentially half as much because we now have only 1/2 acre of water surface. Conversely, if we double the length of the original pond (435.6 x 2) so as to provide 2 acres of water surface, the film-chemical cost would be approximately the same, but water savings in terms of gallons of water saved per unit weight of film chemical would be doubled. As a result, a cost of 10 cents per 1,000 gallons of water saved may be visualized. Thus, we see that greatest economy in a water-saving program may be realized on ponds of the same water area that present the shortest shoreline normal to the prevailing wind.

Microbiological Aspects of Evaporation
Control by Film Chemicals

Limited microbiological studies were conducted on water from both the control and test pond of the twin-pond test facility in Throckmorton County also used for numerous evaporation-control field studies (see page 47). Data obtained indicated no appreciable difference in the total bacterial counts of the surface water from the control pond and the test pond which was treated with a 1:1 mixture of hexa- and octadecanol. However, bottom water from the film-treated pond gave total bacterial counts that were measurably higher than for the bottom water of the control pond. These findings are in keeping with bacterial-count data obtained in the Kids Lake investigation (Committee of Collaborators, 1959).

One possible reason for the increased count may be the oxidation of the straight chain fatty alcohols by bacterial forms of life to form fatty acids. These fatty acids combine with calcium and magnesium ions in the water to form an insoluble soap. This soap in turn could be adsorbed on a particle of silt and settle to the bottom where the fatty alcohols and soap provide a possible source of energy for the growth and reproduction of the microbiological flora at the bottom of the pond. This postulate is supported by the difference in turbidity noted in the control and test pond waters at Throckmorton. Water samples from the film-treated pond were clean whereas those from the control pond were turbid.

The fatty alcohols may serve as sources of energy for the microbial population of lake or pond water, but scarcity of other essential growth metabolites could influence the rate at which the fatty alcohols are consumed by the bacteria of the water. Laboratory studies showed that the bacterial population of pond water, covered with an excess of fatty alcohol, increased rapidly when small quantities of vitamins, amino acids, pyrimidine, and purines were added to the water. Unsupplemented water showed no such increase in bacterial population. Thus, the addition of film chemical to a fertilized pond of water possibly could give rise to a large increase in the bacterial population of the pond water. The nutrients provided by the fertilizer could enhance the rate of utilization of the fatty alcohols by the microbial flora in the water.

The authors believe that the bacterial population does not alter the economics of film-chemical evaporation-control procedure, at least for small bodies of water. Rather, the presence of nonpathogenic bacteria in the water is considered a desirable feature. The residence time of a given particle or quantity of film chemical on the water surface is relatively short. Surface wind carries the film across the water and deposits it on or near the downwind shoreline. Thus, the effective evaporation-controlling residence time of a given film, formed near the upwind shoreline, on the surface of small bodies of water is short. As a result, the time for microbial action is short. Consequently, the film structure is not altered materially by bacterial action during its progress across the surface of the water.

The film chemical carried by the surface wind to the downwind shoreline could create an undesirable situation in the absence of microbial activity. For this reason, it is deemed advisable to have a population of saprophytic microorganisms in the pond water to serve as scavengers for the excess film chemical which collects on or near the downwind shoreline. This area of research,

microbiological aspects of evaporation control by film chemicals, should be subjected to further research investigations. Specifically, these studies should include the role of bacteria in the clarification of water treated with fatty alcohol films, the effect of a pond-fertilization program--with and without added fatty alcohols--on bacterial counts of the water, and the rate of utilization of the fatty alcohols by pond microbial flora with and without fertilization.

Investigation of Film Movement on a Body of Water
as Influenced by Surface Wind Travel

The problem or question of wind velocity and film movement was investigated on a large farm pond 4 miles southwest of College Station. For this study, five small plastic bouys were attached at 10-foot intervals in the center of a 300-foot length of fishing line. One end of the bouy line was attached to a firmly anchored boat in the lake while the other end was held on the bank by one of the personnel conducting the test. The procedure for determining the rate of film movement was as follows:

1. The operator in the boat applied 1 milliliter of lauryl alcohol to the water surface to form a film patch which was readily visible to the operators on the bank.

2. The operator holding the bouy line on the shore walked along the bank and oriented the bouys in the center of the advancing patch of film.

3. When the lead edge of the film touched the first bouy, a third operator on the shore started a timer and gave a signal to the operator in the boat to start the anemometer for wind-travel measurements.

4. When the lead edge of the film touched the second bouy on the string, a film travel of 10 feet, the operator on the bank signaled the operator in the boat for a wind-travel reading and at the same time noted the timer reading.

5. Procedures 3 and 4 were repeated for the second, third, and fourth 10-foot spacings of the bouys.

6. The above procedures were repeated on the trail or back edge of the film.

The film-movement studies presented in Table 12 indicate a film movement of 3.4 feet per 100 feet of surface wind travel measured at 15 to 18 inches from the water surface. This figure is in keeping with film travel reported by Keulegan (1951) and Vines (1960) of 3.3 and 3.6 percent of the surface wind travel. Furthermore, Keulegan suggested that such a rate of film travel was constant for wind velocities ranging from 3 to 27 miles per hour. McArthur (1962) observed that film travels increased as residence time of film on water increased. According to McArthur's data, secured on a large body of water, film travel increased from 4 feet per 100 feet of wind travel up to as much as 7 feet per 100 feet of wind travel measured 18 inches above the water surface. These findings would be of importance in evaporation-control programs on large lakes because they suggest the need for more film chemical than the 3.4 percent film travel suggested by this study or by the data secured by Keulegan and Vines.

Table 12.--Film movement as a function of wind travel

					<u>Film travel--Percent of wind travel</u>
<u>Run no. 1</u>					
Lead edge of film					--
Film travel, feet	10	10	10	10	<u>Total</u> 40
Air travel, feet	--	--	--	--	--
Time, seconds	32	37	25	30	124
Trail edge of film					3.12
Film travel, feet	10	10	10	10	40
Air travel, feet	--	--	--	--	1,279
Time, seconds	75	45	45	75	240
<u>Run no. 2</u>					
Lead edge of film					3.47
Film travel, feet	10	10	10	10	<u>Total</u> 40
Air travel, feet	357	288	240	272	1,157
Time, seconds	38	37	37	42	154
Trail edge of film					3.41
Film travel, feet	10	10	10	10	40
Air travel, feet	370	215	305	282	1,172
Time, seconds	45	55	48	62	282
<u>Run no. 3</u>					
Lead edge of film					3.88
Film travel, feet	10	10	10	10	<u>Total</u> 40
Air travel, feet	353	245	220	240	1,030
Time, seconds	40	35	40	30	145
Trail edge of film					3.11
Film travel, feet	10	10	10	10	40
Air travel, feet	320	320	295	353	1,288
Time, seconds	40	45	40	35	160

These data on film movement by surface wind travel impose two features on a water evaporation control program: film chemical must be applied at a constant rate at the upwind shoreline in order to provide a continuous film on the water, and more film chemical must be applied at the upwind shoreline as wind travel increases. These features suggest the use of wind-regulated dispensers near the upwind shoreline to provide the film chemical as a function of the surface wind velocity.

Preparation and Properties of Liquid Emulsions of Aquasave

Liquid emulsions and suspensions have been suggested by Dressler^{3/} as means of applying an evaporation retardant film chemical. Drew (1958) designed, constructed, and field tested a wind-regulated dispenser for a suspension and/or an emulsion. A liquid emulsion provides a liquid form of the fatty alcohol film chemical in an aqueous phase rather than as a solution in organic solvents which add to the cost of an evaporation program and also create a potential fire hazard. The liquid emulsion can be applied to the water surface by wind-regulated metering from a constant-head dripper arrangement.

Extensive laboratory investigation on the preparation of liquid emulsions based on the solid emulsion formulas of Table 2 resulted in suspensions. That is, shortly after or during mixing of the oil phase (mineral oil, Aquasave, and emulsifiers--or Aquasave and emulsifiers) into the water phase there was a separation of the components. This separation resulted in a water phase and an oil phase or a sediment of finely divided Aquasave. Of the emulsifiers studied, the Arlacels and Tweens produced by the Atlas Chemical Industries, only Tween 20 and Tween 40 gave emulsions of some stability. The most stable emulsion^{4/} contained Tween 20, mineral oil, water, and Aquasave. This particular emulsion formulation, with a density of 0.954 and 0.934 grams per cc at 25 and 35°C, respectively, was stable for periods greater than 6 months. Deviations from this formulation--such as omission of mineral oil, decreasing the quantities of Aquasave with a fixed weight of water (450 grams), and using Tween 40 as the emulsifying agent--provided emulsion of inferior stability. An emulsion containing only 5 percent Aquasave, instead of 9.87 percent as per the stable emulsion formulation, was stable for 1 to 2 weeks. Thereafter it began to show a water layer in the bottom of the container.

These results with Tween 20 are in keeping with the HLB (Hydrophile Lipophile Balance) numbers for evaluating the character of an emulsifying agent. Based on an example calculation published by the Atlas Powder Co. (1961b), in the preparation of an oil-in-water (O/W) lotion, the emulsion containing Aquasave (50:50 mixture of hexa- and octadecanol), mineral oil, and water should be made with an emulsifier with an HLB number of 14.6. This is established as follows:

^{3/} Application or use of the liquid emulsion technique, regardless of method of application is covered and protected by U. S. Patent 2,903,330, issued in December 1959 to Russell G. Dressler, Chemical Process Consultant of San Antonio, and permission to use the process must be obtained under license agreement.

^{4/} Emulsion Composition: Water, 88.88 percent; Aquasave, 9.87 percent; Mineral Oil, 0.98 percent; Tween 20, 0.27 percent.

The combined total of mineral oil (0.98 percent) and Aquasave (9.87) of the stable emulsion represents a 10.95 percent oil phase, of which 9.1 percent is mineral oil and 90.9 percent is Aquasave. Furthermore, from the published example, mineral oil requires an emulsifier with an HLB number of 11 and hexadecanol (cetyl alcohol), an emulsifier with an HLB number of 15. Calculation for the HLB of the emulsifier for the mixture is:

$$\text{Mineral Oil: } 0.98/10.85=0.091 \times 11= 1.0$$

$$\text{Aquasave: } 9.87/10.85=0.909 \times 15=13.6$$

Total 14.6=HLB number for emulsifier
for the mixture

The above calculations suggest the use of Tween 80, 60, 40, or 20 with HLB numbers (Atlas Powder Co., 1961b) of approximately 15.0, 14.8, 15.6, and 16.7, respectively. However, of the formulations tested only Tween 20 provided a stable emulsion. If an emulsion contains a surface active agent, such as fatty alcohol, probably an emulsifier with a higher HLB number than the calculated value would be required (Atlas Powder Co., 1961b). This was the case in question with the emulsion of Aquasave.

As mentioned earlier, the density of the liquid emulsion prepared with Tween 20 ranged from 0.954 at 25°C to 0.934 at 35°C. This was fairly constant from batch to batch. However, the viscosity of the resulting emulsion was a function of cooling after the preparation of the emulsion--which was as follows: Aquasave (600 grams), Mineral Oil (80 grams), and Tween 20 (15 grams) was heated to 55°C to provide a uniform melt. This melt was then poured slowly into 5,400 grams of water at 55°C with constant stirring (400 to 500 rpm) as obtained by a laboratory, multiple-vaned stirrer inserted into the chuck of a drill press. Addition of oil phase to the water was realized in from 1 to 2 minutes and followed by a stirring period of 2 to 3 minutes.

This emulsion was quite fluid at the 55°C preparation temperature and the fluidity decreased as the temperature decreased to around room temperature, 25°C. However, the decrease in fluidity or ultimate viscosity was a function of cooling procedures--a fact which was not apparent in small-batch (1/12 of the above preparation quantities) preparations where cooling was rapid with occasional shaking. Cooling procedures as related to fluidity or viscosity of the ultimate emulsion may be summarized in the following manner:

P-1.--A large volume of hot (55°C) liquid emulsion to be used in field testing was poured into a clean 5-gallon can and capped. Other batches were prepared and poured into cans until a total of six 5-gallon cans had been filled. The filled cans were stored in an air-conditioned laboratory and each can was agitated several times each day. Cooling to room temperature, without stirring, resulted in a redistribution of the water; that is, rapid cooling without stirring at 25°C caused water to migrate from the hot center portion of the emulsion of the can. This left a thin zone of emulsion around the outside of the can and a semisolid lump (gel) in the center of the can.

P-2.--A second group of six 5-gallon cans of emulsion was prepared by forced cooling with constant stirring. This was accomplished by directing laboratory air, at 25°C, with a floor fan onto the container as the emulsion was being prepared. Cooling in this manner was continued for 15 to 20 minutes with constant

stirring. At the end of this period the emulsion was around 30°C and was poured into 5-gallon containers. This preparation procedure produces a fluid emulsion that does not form the center lump of semisolid emulsion realized in P-1 above.

P-3.--One standard batch (600 grams of Aquasave, 60 grams of mineral oil, 15 grams of Tween, and 5,400 grams of water) was prepared in a room at 33°C with a total stirring time of 20 minutes. The container was then allowed to cool in a room at 33°C with occasional gentle stirring with a spatula. The following morning both the room temperature and the emulsion temperature had dropped to 30.5°C. This emulsion had greater fluidity than the preparation obtained by procedure P-2 given above.

P-4.--A batch of emulsion was prepared as per P-3 above and cooled to 41°C with spatula stirring at intervals, in a room at 33°C. It was then cooled to 31°C in a water bath at 27°C, again with an occasional spatula stirring. Finally the emulsion was cooled to 25°C in front of an air conditioner with essentially constant stirring with a spatula. This preparation exhibited the greatest fluidity.

Viscosity approximations were made on P-2, P-3, and P-4 with a Zahn viscosimeter which is suitable for use with viscous materials. This instrument is merely a stainless steel cup, 44 ml volume with a hemispherical bottom. In the bottom of the cup is a hole. In viscosity measurements the cup is immersed in the solution and then withdrawn. The time in seconds required for the cup to empty, as evidenced by a sharp break in flow of the fluid, is determined. Calibration charts afford calculation of the viscosity in centipoises. The emulsions did not give a sharp break and therefore the following tabulation of viscosity values is an approximation at best and only supports the visual observation that there was a decrease in fluidity of the emulsion from P-2 to P-4.

Preparation	Viscosity, in centipoises		
	25°C	35°C	45°C
P-2	360	275	--
P-3	240	226	183
P-4	168	141	126

The viscous character of the liquid emulsion suggested the use of small-diameter tubing of various lengths to serve as a means of controlling or metering the emulsion onto the water surface of a pond or lake from an elevated-head supply tank. Laboratory data, Figure 9 and Table 13, provide evidence that various flow rates may be obtained for a given emulsion at a given temperature by changing hose or tubing length, by changing the head of emulsion with a given hose length, or by using hoses of different inside diameter. However, for different emulsions (P-3 and P-4, Figure 9) with the same length of hose (30 feet) at a given emulsion head, the flow rates were drastically different. For example, with an emulsion head of 80 inches, the flows for emulsions P-3 and P-4 through a 30-foot length of 5/16-inch inside diameter Tygon (plastic) tubing was about 400 and 1,000 grams of emulsion per 10 minutes, respectively. These flow rates would represent the addition of essentially 12 and 30 pounds of Aquasave to a body of water per day. Further analysis of the data on flow rate versus emulsion head (Table 13) shows that the addition of small quantities of Aquasave,

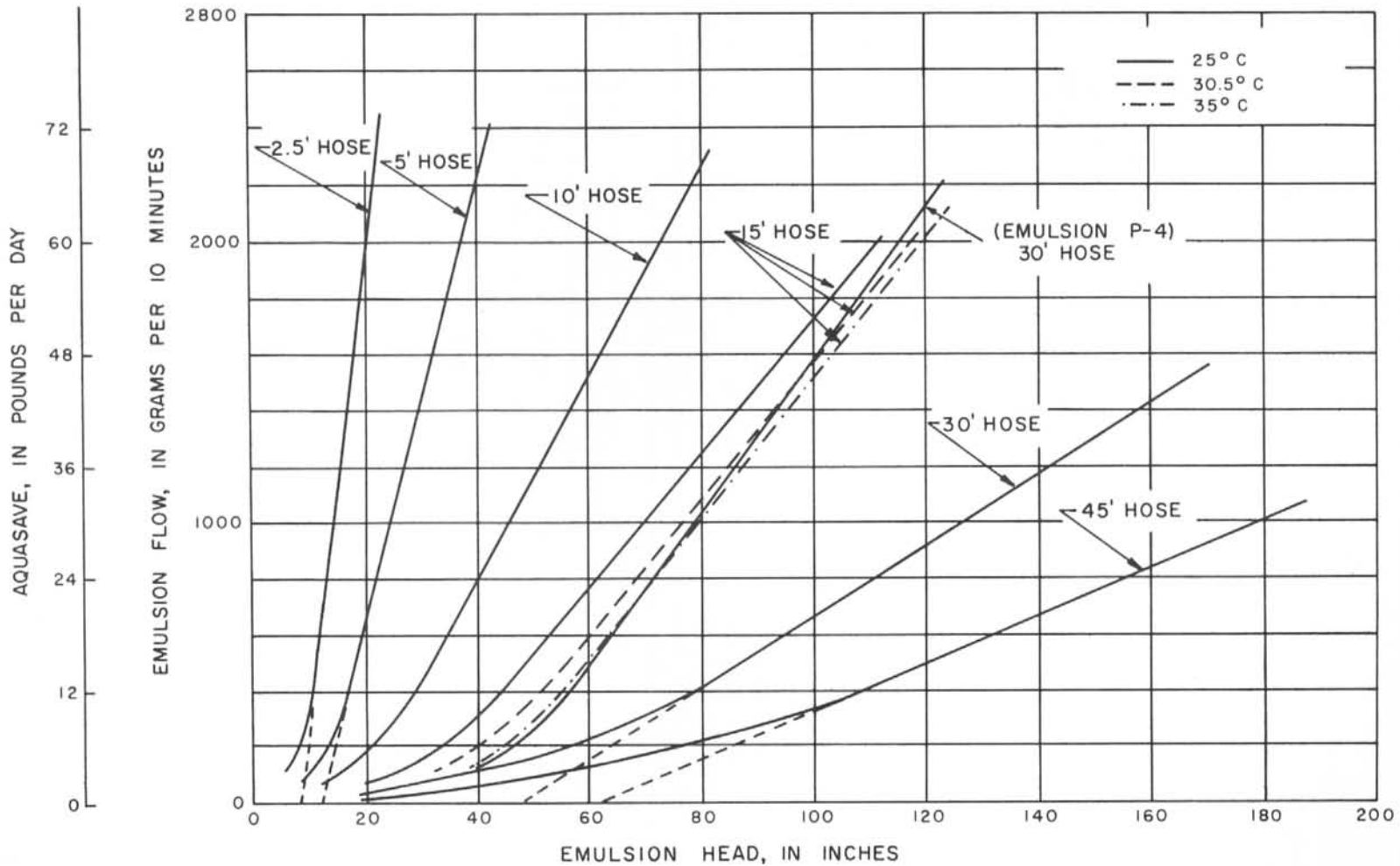

Figure 9
Rate of Flow of Liquid Emulsion P-3 Through 5/16-Inch (I.D.) Hose

Texas Water Commission in cooperation with the Texas A & M Research Foundation

Table 13.--Liquid-emulsion flow rate as influenced by hose diameter

Emulsion no.	Emulsion head (inches)	Hose length (feet)	Emulsion flow rate (grams/10 min.)	
			1/4-inch I.D. hose ^{a/}	5/16-inch I.D. hose ^{a/}
P-4	120	30	880	1,750
P-4	86	30	505	1,110
P-4	41	30	125	256
P-4	19	30	19	38

^{a/} Flexible Tygon tubing.

such as the amount required for a small farm pond, would require long lengths of 5/16-inch hose or shorter lengths of 1/4-inch hose. There is a doubling of emulsion flow at a given emulsion head in changing from 1/4- to 5/16-inch tubing of the same length.

The variability in flow rates of different emulsion preparations, as well as viscosities, is in keeping with previous observations on hydrophilic oil-in-water emulsions. Weiser (1939) in his textbook on Colloid chemistry expresses this variability as follows: "Many factors affect the viscosities of hydrophilic sols; concentration, temperature, degree of dispersion, solvation, electrical charge, previous thermal treatment, previous mechanical treatment, presence or absence of other hydrophilic colloids as impurities, presence of both electrolytes and nonelectrolytes, and rate of flow." Furthermore, Weiser points out that in true viscous flow the rate is proportional to the driving force--or the emulsion heads of Figure 9. However, hydrophilic sols or emulsions generally follow "psuedoplastic" flow. That is, a certain amount of pressure must be applied to overcome the "yield value" of the emulsion before true plastic flow is obtained. Curves of Figure 9 are typical of "psuedoplastic" flow, and the intercept of the broken line, an extension of the plastic flow sections of the curves, with the zero flow axis is a sum of the yield value of the emulsion and the pressure drop due to the length of the hose. With short lengths of hose the "yield value" is significant in comparison with the hose pressure drop. With long hoses the "yield value" is more or less masked by the pressure drop.

The decrease in flow rate of emulsion preparation P-3 through a 15-foot length of hose with an increase in temperature (Figure 9) is of interest. Emulsion preparation P-1, with a 12-foot length of 1/4-inch hose, gave similar results. The reason(s) for decreased emulsion flow at higher temperatures, despite lower "apparent" viscosity and higher visual fluid character at higher temperatures, is not apparent and further research is needed to verify the observed phenomenon.

These flow-rate studies were conducted by weighing the emulsion delivered by a hose, used as a flow-regulating mechanism, attached to an elevated supply bottle. Figure 10 compares flow rates of this system with those obtained when the system was provided with six equally spaced emulsion outlets or jets. The

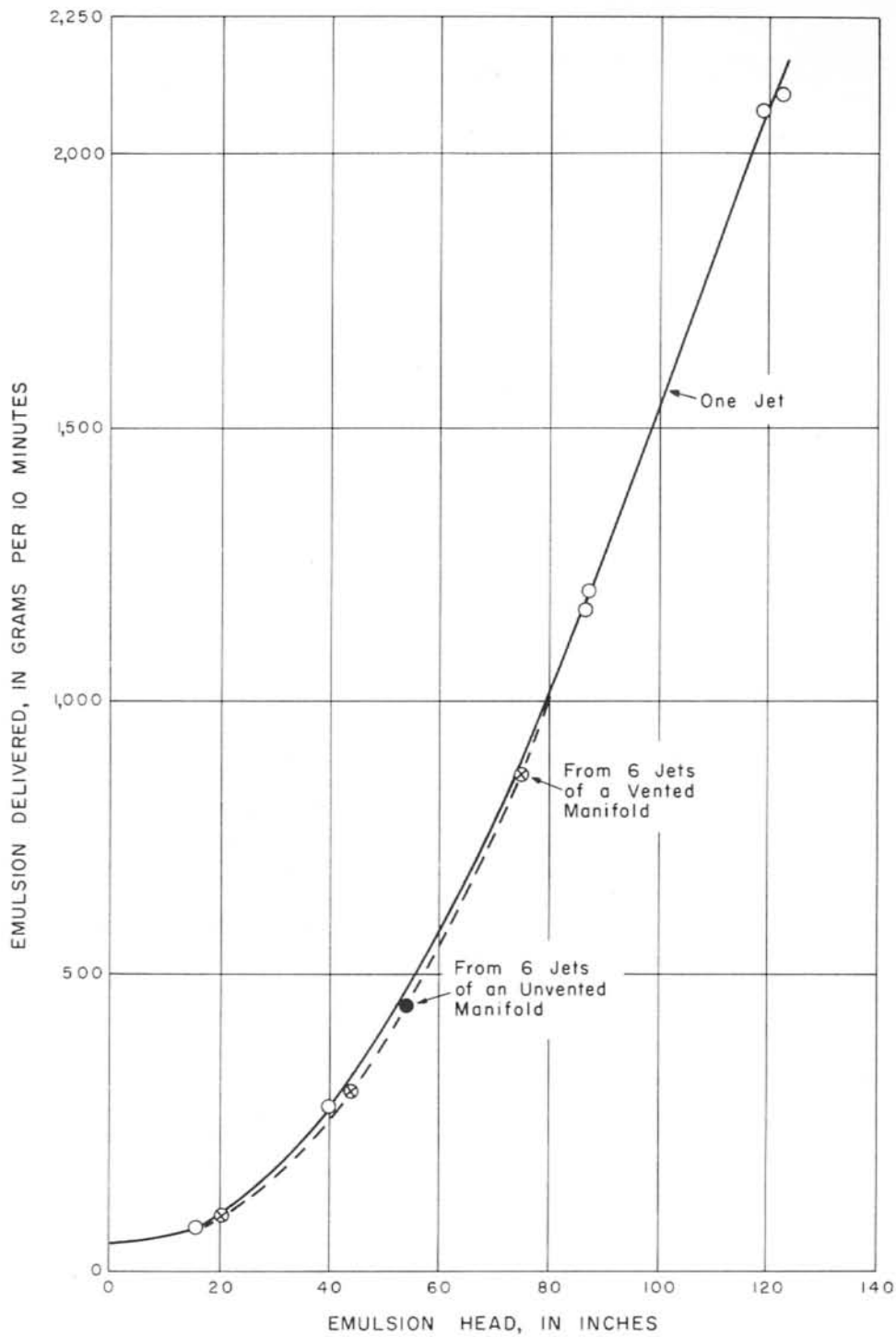

Figure 10
 Liquid-Emulsion Flow Through 30-Foot, 5/16-Inch (I.D.) Hose at 25°C
 Texas Water Commission in cooperation with the Texas A & M Research Foundation

distribution network consisted of a 1-1/4 inch pipe with six 1-inch copper tubing nipples of 5/16-inch inside diameter soldered into holes drilled at 5-inch intervals in a line along the length of the large pipe. The pipe also was fitted with two copper nipple vents which were soldered into holes drilled perpendicular to the line of six distribution jets. Finally, a 5/16-inch copper tube nipple, soldered into place in the middle of the length of the tube and 120 degrees removed from the line of jets, served as a means of attaching a 30-foot length of hose which in turn was attached to the emulsion supply bottle. This distribution system, or manifold, was tested in two ways: with vent tubes open and with vent tubes sealed. With vents open, the emulsion did not fill the pipe completely, but moved up only to the level of the six jets where the emulsion dripped or ran from each opening. For the closed-vent study the entire manifold system was filled by sealing the jets and thus allowing the emulsion to displace the air in the system through the vent tubes. Vent tubes then were sealed.

With both manifold systems, vented and sealed, the flow rates from each of the six jets were obtained by weighing the emulsion which flowed into tared petri dishes during measured intervals of time. The data of Figure 10 show that the cumulative flow from the six jets of both the vented and unvented systems was essentially the same and was approximately equal to the flow from the tube alone--"one jet." Flow rates from individual jets varied as much as 50 percent. However, equal flow rates could be established by proper short lengths of Tygon tubing attached to the copper tube jets. This type of distribution was applied in a test on the "twin ponds" and is discussed in the following section of this report devoted to field tests.

EVAPORATION-CONTROL FIELD STUDIES ON TWIN PONDS

Description of the Facility

The twin-ponds test facility is located on the Texas Experimental Ranch, approximately 20 miles south of Seymour, Texas in Throckmorton County. A fairly large earthen dam was constructed in pasture G (Figure 11) to impound a supply of water which could be used to fill or relevel the twin ponds. The twin ponds were located east of the supply reservoir in pasture H. They were earthen-dug reservoirs separated by a common dike. Likewise, dikes were built up on the other sides of the two ponds to a level of the common center dike in order to prevent the entry of surface runoff water. Prior to completion of the pond dikes, a continuous sheet of polyethylene film was placed over the bottom and sides of the pond excavations and then covered with 1 foot of soil. The layer of film was installed in order to obviate or reduce water losses due to seepage.

The final twin ponds were identical in construction details and when filled to a depth of 5 feet afforded water surfaces of 75 by 100 feet--or 0.172 acre of water surface. The 100-foot shorelines of the ponds ran in an east-west direction and the 75-foot shorelines were oriented in a north-south direction. This orientation exposed the 100-foot shoreline to the prevailing wind which in general is from either the north or the south.

Auxiliary equipment or installations included in the twin-pond test facility included an anemometer and rain gauge located on the center dike and a weather station that was equipped with U. S. Weather Bureau and Young evaporation pans,

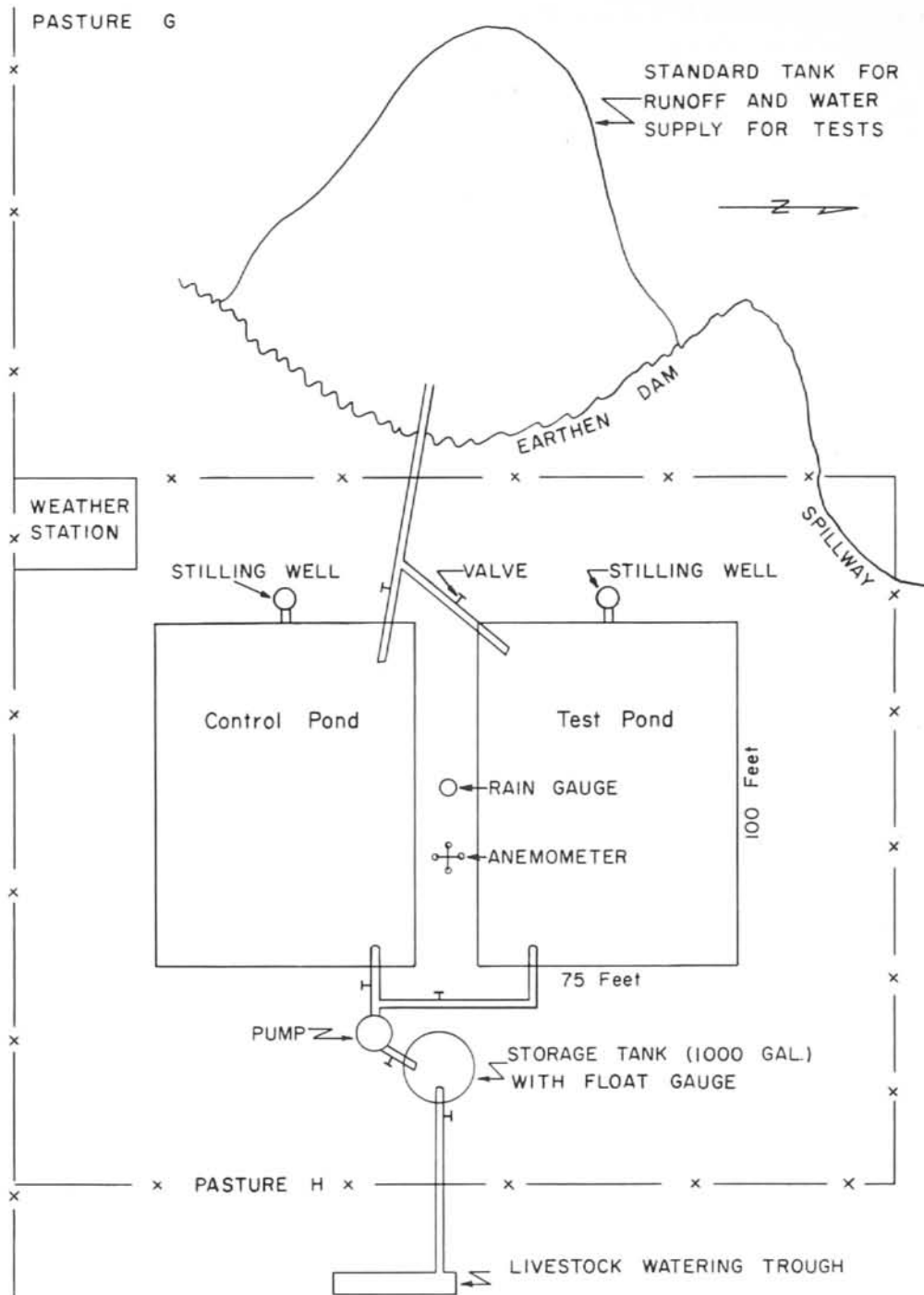

Figure II
 Sketch Map of the Large Earthen Dam and Twin-Pond
 Test Facility, Throckmorton County
 Texas Water Commission in cooperation with the Texas A & M Research Foundation

an anemometer, and thermometers for maximum and minimum air-temperature measurements. Also included as part of the facility was an elevated water tank of 1,000-gallon capacity which provided a water supply to cattle tanks located outside the fence which enclosed the twin ponds. The elevated tank was filled from either of the two twin ponds by a pipe and valve system coupled to a pump. A gauge on the elevated tank permitted the estimation of the volume of water withdrawn from either or both of the twin ponds. Corrections for volumes of water removed from the twin ponds were applied to evaporation results.

Water losses from the twin ponds were measured in inches, rather than volume, by a chain contained in the stilling well of each of the ponds. This chain was calibrated to permit direct readings to 0.01 foot. Actual drop in water level was determined by subtracting a given water-level reading from the previous day's figure. For a water-surface area of 75 by 100 feet (0.172 acre), a drop in water level of 0.01 foot or a saving of 0.01 represents a water volume of 561.75 gallons, or about 562 gallons. Such a change, 0.01 foot, would represent 3,266 gallons if applied to 1 acre of water surface.

The northernmost pond, No. 1, was selected as the test pond for film-chemical addition and pond No. 2 served as the check or control pond. The water level in the two ponds at the beginning of the program provided water surfaces of only 50 by 80 feet--or about 0.092 acre of water surface.

Descriptions of Tests Performed

The following are discussions of 14 series of evaporation-control field tests on the twin-pond facility involving addition of Aquasave 1-SD (a 50:50 mixture of hexa- and octadecanol) as a solution in isopropanol, in a mixture of isopropanol and hexane, and as an emulsion--both solid and liquid. The evaporation data are presented in the date order in which they were obtained from the starting date of July 7, 1959 to September 10, 1963. For convenience of discussion, the test runs have been assigned numbers as T1, T2, etc.

Test T1, July 7 to August 25, 1959

During the 48-day test period, approximately 60 floating rods of emulsion^{5/}, were attached together by heavy twine and placed on the water surface of the test pond of the twin-pond facility. In the initial setup, the rods were made into five strings--three were placed lengthwise on the water surface and two were oriented perpendicular to the other three strands of rods. This pattern was altered so that 60 rods were contained on only two strands which were placed 2 feet apart and approximately 3 feet from the upwind shoreline.

At the conclusion of the test period, evaporation data taken from the two stilling wells showed a 0.01 foot greater loss from the treated pond than from the control pond; that is, no water saving was provided by the solid emulsion. However, the same emulsion gave water savings approaching 50 percent in the aluminum tank investigations (Table 5). In those small-tank studies, the

^{5/} Composition given in footnote^{1/} on page 13.

emulsion provided a film cover to the small water area, whereas no such capability was evidenced on the test pond. Film-pressure readings taken on the test pond by means of test mixtures of dodecanol and mineral oil of known film pressure revealed a compressed film near the downwind shoreline but essentially no film pressure on the water near other shorelines. Another reason for the failure of the rods in field test could have been due to algae which started growing on the fatty alcohols. The data provided by the aluminum tank studies showed that the addition of "copper oleate," prepared from Ivory soap and copper sulfate, prevents algae growth on the rods without impairing the water-saving properties of the emulsion. However, evaporation study T4 conducted with the same emulsion preparation as T1 with the addition of 0.25 parts by weight of "copper oleate," during the period August 17 to 29, 1960 again showed no water-saving potential for the emulsion formulation.

Failure to obtain any water saving on the test pond was possibly due to the character of the water in comparison to that used in the small-tank studies which provided essentially 50 percent water savings. Water from the twin ponds had a hardness of 134 ppm (parts per million), expressed as calcium carbonate, as compared to 5 to 10 ppm and approximately 60 ppm, respectively, for tap and pond water used in the small-tank studies at College Station. The emulsion contained 1.5 parts by weight (approximately 2 percent) of Ivory soap; therefore, it was suggested that the calcium and magnesium ions in the pond water formed insoluble soaps from the Ivory soap of the formulation, thus sealing the rods in a film of insoluble soap. In fact the rods on the pond were quite firm even after extended residence time on the pond. In contrast, the rods in soft water became soft and covered with a mucoid or gel-like layer. This concept of the effects of water hardness also could carry over to pure Aquasave or other emulsions during microbial degradation of the fatty alcohols which give rise to fatty acids. That is, fatty acids formed by microbial forms of life on the rod could form insoluble soaps over rods or chunks of fatty alcohol evaporation retardants that remain in the water for an extended period of time.

Test T2, September 11 to November 19, 1959

A 20 percent by weight solution of Aquasave in 99 percent isopropanol was supplied to the test pond in this field experiment. The dispensing system for the solution consisted of a 55-gallon supply drum mounted on a framework on the dike of the test pond. This supply drum provided the solution for a constant-head chamber, in which constant head was maintained by a float valve. The solution ran by gravity from this system through 1/2-inch polyethylene tubing and was released to the water surface by three capillary drippers which regulated the flow of the solution. The plastic tubing with attached drippers, one in the center of the lengthwise dimension of the pond and one spaced on either side of the center at a distance of 20 feet, was supported by three floating metal drum buoys.

The three capillary drippers near the upwind shoreline were designed to deliver a total of 5 ml. of solution per minute--or approximately 3 pounds of solvent-free Aquasave per day. However, malfunction of the dripper units was experienced when the air temperature dropped below 54°F, and on an average only one-third of the volume was delivered in the 70 days of test. The malfunction was due to crystallization of the Aquasave in the polyethylene feed lines and the capillary drippers. When this happened the drippers no longer delivered the

solution to the water. Mere return to higher daytime temperatures failed to restore operation and thus it was necessary to overhaul the distribution system. Likewise, small foreign particles caused plugging of the capillaries at times during the run.

Despite the malfunction of the drippers, a total of 0.79 feet of water was evaporated from the test pond receiving the isopropanol solution and 1.02 feet from the untreated pond. This was for a 70-day test period, from September 11 to November 19, 1959, on bodies of water which were 2.21 and 2.14 feet deep for the test and control ponds respectively, and were raised to a level of 3.10 and 2.85 feet by a heavy rain on October 3. The water saving of 0.23 feet was realized through the addition of approximately 70 pounds of Aquasave and 280 pounds of alcohol. Assuming 0.172-acre water surface, which is not true because the full 5-foot pond depth was not available for the test, the 0.23 feet saved would represent 12,926 gallons of water saved over a 70-day period. Based on the Aquasave alone at 48 cents per pound, or a total of \$33.60, a cost of \$2.60 per 1,000 gallons of water saved is obtained. The \$30.24 cost for approximately 42 gallons of alcohol (280 pounds) would add about \$2.40 per 1,000 gallons of water saved--for a total of \$5.00 per 1,000 gallons of water saved. As has been pointed out earlier in this report, water-surface area has a tremendous effect upon ultimate water-saving costs, and for 1 acre of water surface the cost would approach 1/6 of the \$5.00 figure--or \$0.83 per 1,000 gallons of water saved. The chief factor in the costs presented above is that with the indicated current prices of isopropanol and Aquasave the alcohol represents approximately 50 percent of the cost and serves only as a vehicle for adding the active evaporation retardant.

Assuming 100 percent film coverage in obtaining the 50 percent water savings in small aluminum tanks of 2.77 square feet water-surface area, the addition of Aquasave in isopropanol in this field test, which saved 23 percent water, afforded a 46 percent (23 divided by 50 times 100) film coverage during the 50-day test period--or approximately 50 percent film coverage was obtained by only upwind addition of film chemical from three drippers spaced at 20-foot intervals along an 80-foot upwind shoreline.

Test T3, April 21 to August 8, 1960

During this time interval the application of the film chemical, as in T2, was as a 20 percent by weight solution of Aquasave in 99 percent isopropanol. However, in this run (T3) the solution was supplied to the water surface by three constant-pressure drippers, one of which is depicted by Figure 12. A length of capillary tubing, held in position by a packing nut, regulated the flow of liquid from the drum. The air vent shown on the sketch afforded a means of maintaining a constant pressure on the capillary tube, and thus the rate of flow from the capillary was not altered by change in liquid head in the drum. The chief difficulty with this system was clogging of the capillary by small foreign particles.

The constant-pressure dispenser cans were suspended over the water on lengths of 2 x 4 which were in turn fixed to a framework of 1 x 4, anchored to the bank by a bent piece of reinforcing steel. This 2 x 4 framework was light enough to permit one man to change it from one position to another. Likewise,

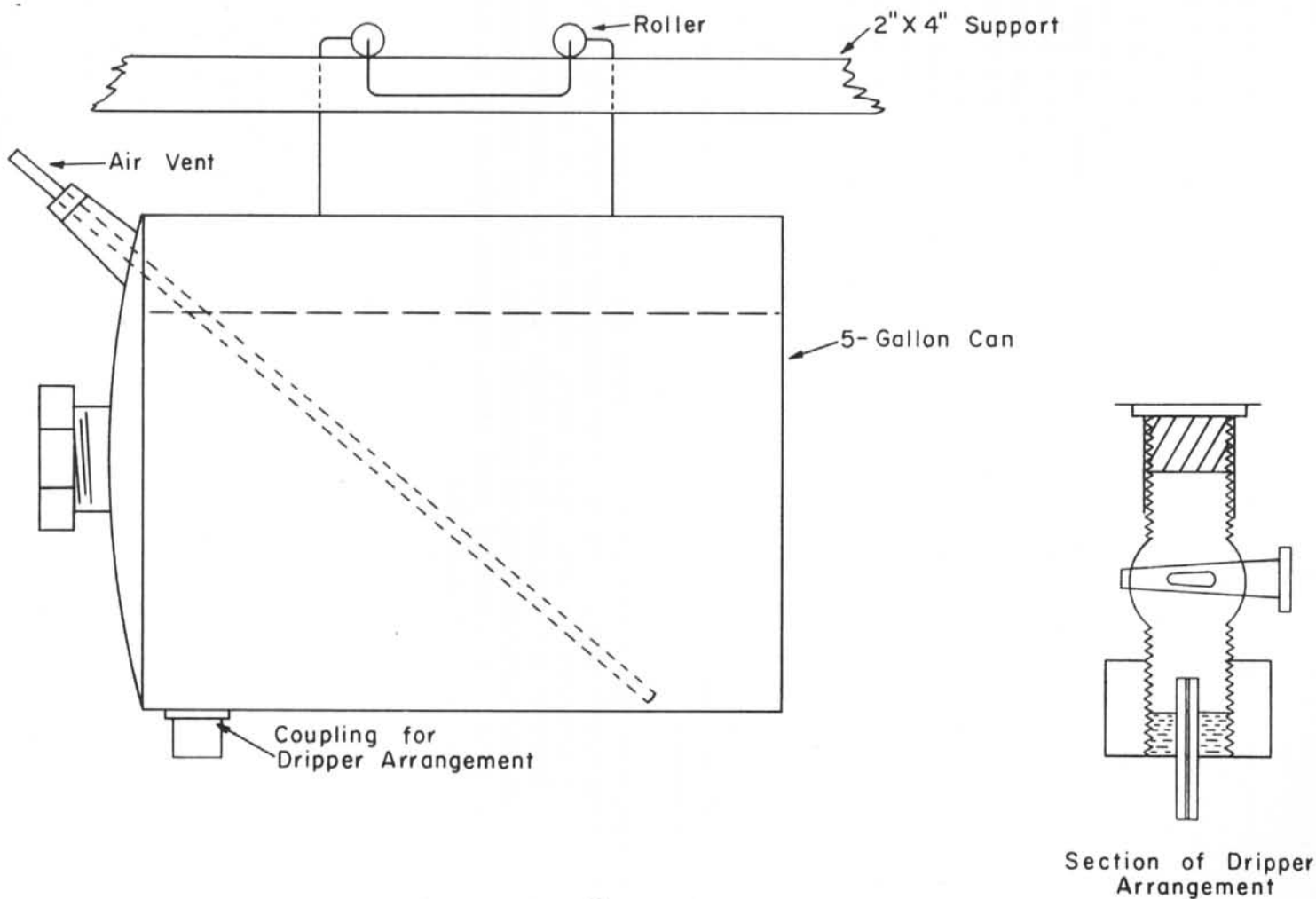

Figure 12
Constant-Pressure Dripper for Dispensing a Solvent
Solution of Fatty Alcohol

Texas Water Commission in cooperation with the Texas A & M Research Foundation

the rollers on the holder for the drums (Figure 12) facilitated the positioning of the dispensers over the water on the 2 x 4 arm or support.

At the start of this test period the levels in the control and test ponds were 4.04 and 4.20 feet respectively. The test period of April 21 to August 8 was interrupted by a period of rainy weather, and therefore data for this period were not too reliable. As a result of this, findings were calculated for a 53-day test period prior to June 13 and a 20-day test period after July 13. During the 53-day test period, an average of 8.9 pounds per day of 20 percent Aquasave solution was added. Over this test period, the control pond level was reduced by 0.91 feet and the treated pond by 0.76 feet, indicating a saving of 0.15 feet of water in 53 days. For the 20-day test period, solution addition averaged 7.65 pounds per day. Water loss was 0.48 feet from the control pond and 0.390 feet from the treated water surface, indicating a saving of 0.09 feet of water. The water saving was 16.5 percent for the 53-day test and 18.75 percent for the 20-day period. For the combined 73-day test covered by the two runs, a total of 0.24 feet of water was saved by the addition of 625 pounds of solution composed of 125 pounds of Aquasave and 500 pounds of isopropanol.

Assuming a water surface of 1/6 acre, as in the discussion of data for T2, the 0.24 feet of water saved during the combined runs would represent a water saving of 13,488 gallons at a combined cost for solvent and Aquasave (\$54.00 plus \$60.00) of \$114, or \$8.45 per 1,000 gallons of water saved. For an acre of water surface where the same quantity of film chemical should be adequate, actual gallons of water saved would approach 6 times the 1/6-acre water surface saving, and the cost for saving 1,000 gallons of water would be about \$1.41 ($\$8.45/6$). If the same water saving could be obtained with Aquasave alone, with no alcohol cost, the calculated cost for saving 1,000 gallons of water would be reduced to approximately \$4.50 and \$0.75, respectively, for 1/6 and 1-acre bodies of water.

The effective film coverage during the 73-day test period, which has been defined at the end of the discussion of T2 as pond percent water savings divided by small-tank water savings (50 percent), was 34.4 percent--this compares with 46 percent effective film coverage for T2 by essentially the same approach. The important difference may have been the depth of water in the ponds during the test; namely, 2 to 3 feet for T2 and 4 feet for T3. This water-level difference could have altered the ease of egress of wind to the two water surfaces.

Test T4, August 17 to August 29, 1960

Twenty-six emulsion rods were applied to the upwind shoreline of the test pond. As in prior test T1, the emulsion preparation^{6/} contained Ivory soap. The rods provided very little or no film coverage and the test pond containing the rods lost more water than the control pond. This field test again provided no water saving as in the case of T1. However, the data obtained during this run, Table 14, showed a loss of 0.05 feet of water more from the test pond than from the control pond. In test T1, the test pond showed a negative saving of 0.01 foot compared with the control pond. Special mention will be made again to these data in a subsequent discussion of this report which points to "twin

^{6/} Composition given in footnote^{1/} on page 13.

Table 14.--Rod-emulsion test T4 on twin ponds

Test dates	Control		Test		Air temp.		Wind movement (miles/day)
	Water level (ft.)	Loss (ft.)	Water level (ft.)	Loss (ft.)	Max. (°F)	Min. (°F)	
8/17/60 (start)	4.18	--	4.14	--	98	71	183.0
8/18	4.16	0.02	4.12	0.02	96	69	151.5
8/19--0.79-inch rain							
8/19 (start)	4.22	--	4.23	--	90	71	101.7
8/21	4.20	.02	4.19	.04	97	67	283.7
8/22	4.19	.01	4.17	.02	99	69	112.4
8/23	4.17	.02	4.15	.02	98	69	133.6
8/24	4.14	.03	4.11	.04	99	75	136.4
8/26	4.10	.04	4.06	.05	98	72	298.4
8/27--0.51-inch rain							
8/28 (start)	4.11	--	4.09	--	--	--	--
8/29	4.09	.02	4.07	.02	--	--	--
Total loss ^{a/}		<u>0.16</u>		<u>0.21</u>			

^{a/} 8-day test uncomplicated by any corrections for rain or water removal for cattle.

character" but not "identical twin character" of the test and control ponds. This particular feature of the twin ponds, as will be pointed out later, was not apparent until the critical review of data which was necessary in the preparation of this report.

Test T5, April, 1961

The constant-pressure dripper cans used in the addition of a 20 percent solution of Aquasave in isopropanol, Test T3, were repaired at College Station and returned to Seymour. Laboratory tests had shown that a 20 percent by weight solution of Aquasave in a 1:1 by volume mixture of hexane and isopropanol was effective in the prevention of crystallization of Aquasave until the temperature dropped to 32°F. A 20 percent by weight solution of Aquasave in 99 percent isopropanol produced crystals at 54°F and below, plugging the dripper capillaries and thus stopping flow. The hexane-isopropanol solution would be the more useful for colder climatic conditions.

The constant-head drippers were filled with a 20 percent Aquasave (by weight) solution in 1:1 by volume hexane and isopropanol and placed over the water on the 2 x 4 supports described in T3. The smaller capillaries again plugged from small particles of foreign matter even though a filter pad was placed ahead of the capillary. Also, wind caused evaporation of the solvent and crusting occurred at the capillary tip, but a wind shield over the tip obviated much of this difficulty. However, the most serious problem associated with the use of hexane was due to the high vapor pressure (low boiling point) of this solvent. As the can heated during the day, the pressure within the can rose more rapidly than the capillary could reduce the pressure, and as a result the liquid was jetted onto the water from the air vent or constant-pressure tube of the dripper. Because of these numerous problems the test with the mixed solvent was discontinued, and the test pond was used for screening tests for emulsion preparations developed in the laboratory phase of the work at College Station.

Test T6, July 6 to July 22, 1961

A prepackaged powder mixture of hexa- and octadecanol prepared and supplied by Proctor and Gamble was tested in pond waters at College Station and also on the twin-pond facility at Seymour. The powdered material was supplied in 1- and 2-ounce quantities packaged in a water-soluble plastic bag. The bag dissolved when placed in the water and the fatty alcohol mixture contained in the bag was free to disperse to the water surface. Bags placed on the upwind side of the experimental pond at College Station dissolved and dispersed in 10 to 15 minutes; however, in this period of time the film and small agglomerates of powder were blown across the surface of the lake and deposited along the downwind shore. In the test run on the twin ponds at Seymour, a package of chemical was placed into each of three copper screen wire baskets fixed in the water near the upwind shoreline. The schedule of basket addition and other data on the test are presented in Table 15. A total of 38 ounces of chemical was applied in the 13-day test period. Summation of evaporation during the period of chemical addition, July 6 to July 19, showed a loss of 0.20 foot of water from the control pond, and for 8 days uncomplicated by rain corrections, 0.16 foot from the test pond. These data indicate a water saving on the test pond of 20 percent.

Table 15.--Twin-pond field test on water-soluble bags of a powdered hexa-octadecanol mixture

Number of baskets	Quantity per basket	Date	Wind travel (miles per day)
3	2 oz.	7- 6-61	--
3	2 oz.	7- 7-61	151.2
3	2 oz.	7- 8-61	151.2
3	1 oz.	7- 9-61	78.7
3	1 oz.	7-10-61	47.9
3	1 oz.	7-11-61	71.5
3	1 oz.	7-12-61	76.4
3	1 oz.	7-13-61	71.8
1	1 oz.	7-14-61	176.9
1	1 oz.	7-15-61	153.7
1	1 oz.	7-16-61	75.3
1	1 oz.	7-17-61	122.8
1	1 oz.	7-18-61	116.5
0	0	7-19-61	151.3
0	0	7-20-61	151.3
0	0	7-21-61	--
0	0	7-22-61	252.9

Eight days (no rain corrections) out of 13 days--7/6 to 7/19-- a water savings of 0.04 foot was realized. Control loss was 0.20 foot and test loss was 0.16 foot.

Period of no chemical addition--7/19 to 7/22--control loss was 0.06 foot and test loss was 0.07 foot.

The evaporation data in Table 15 for the period of no chemical addition, July 19 to July 22, indicate no residual effect from the 38 ounces of material added prior to July 19. In fact the test pond lost 0.01 foot of water more than the control pond. The positive saving, 0.04 foot during 8 days, is suggestive that the use of a powdered fatty alcohol restrained by a copper screen mesh basket could have merit in controlling evaporation from small ponds. The concept of the soluble plastic package affords no advantage to an evaporation-control program except a convenient means of storing and adding the chemical. In fact, other powdered preparations of hexa- and octadecanol, such as powdered Aqualoc produced by M. Michel and Co., would react in a similar manner. The water-saving potential arises from the fatty alcohols and not the soluble package. It is the opinion of some, who have tried the soluble-package concept, that the chemicals added by the soluble package function to weaken the film produced by the fatty alcohol. Influence of impurities such as solvents, emulsifiers, and soluble packages on film strength is discussed in a subsequent section of this report.

Test T7, August 14 to August 25, 1961

Emulsion preparation No. 211 (211C) without mineral oil was prepared in quantity for field testing on the twin ponds at Seymour. The emulsion formulation was prepared as follows:

1. Quantities of Aquasave, emulsifiers, and copper oleate, as given by Table 2 for emulsion 211 without mineral oil, were weighed into a container and heated to 60°C to form a uniform liquid melt.
2. The indicated quantity of water was weighed into another container and also heated to 60°C.
3. The melt of step 1 was poured slowly into the water with constant stirring as provided by an electric stirrer.
4. The liquid emulsion was poured into pans to form a cake 1/4-inch thick. The cool cake was cut into 1-inch squares, and a total of 200 grams of these chunks was placed in each of numerous nylon mesh bags.
5. A plastic rod float, the same as used for the rods, also was placed inside the bag. Ends of the bag were secured to the ends of rods by twine. The plastic floats were then connected by 3-foot lengths of cord to form a continuous string or line of chunk emulsion packages.
6. For field testing, the emulsion bags were strung across the upwind side of the test pond, 3 to 4 feet from the shoreline.

Twenty-six nylon net bags, each bag containing 200 grams of chunk emulsion, were placed on the test pond at Seymour at 8 a.m. on August 14. These bags of emulsion had dispersed completely by the morning of August 23. At this time another string of 26 bags was placed on the test pond. Wind travel, temperature, and water-loss observations for this field test are recorded in Table 16. Film-pressure measurements also were made during the test and some representative readings are indicated on Figure 13. Pressure measurements were obtained with standard mixtures of lauryl alcohol and mineral oil of known film-pressure

Table 16.--Twin-pond test with emulsion 211 without mineral oil

Date	Wind travel (miles ^a)		Wind direction		Temperature		Water loss (feet)	
	8 am to 5 pm	5 pm to 8 am	8 am	5 pm	Max.	Min.	Test	Control
8-14-61	51.0	61.3	SW	NE	96	68	--	--
8-15-61	33.1	35.5	SE	S	93	70	0.01	0.01
8-16-61	31.5	54.1	S	SE	96	66	.01	.02
8-17-61	33.6	31.4	SE	E	91	67	0	.01
8-18-61	33.0	--	E	E	95	65	.02	.01
8-19-61	--	--	--	--	--	--	--	--
8-20-61	--	13.6	--	E	95	65	.03	.04
8-21-61	66.7	79.2	S	SW	94	60	.02	.02
8-22-61	99.9	76.8	NW	N	91	70	.03	.04
8-23-61	69.8	27.4	NE	NE	85	56	.02	.02
8-24-61	31.3	27.4	SW	S	89	52	.02	.02
8-25-61	51.9	--	SE	S	94	59	.01	.02
Average	50.2	45.2			Total		0.17	0.21

^aTotal wind travel from 8 a.m. August 14 to 5 p.m. August 25 was 1,111.6 miles or 97.8 miles per day (24 hours).

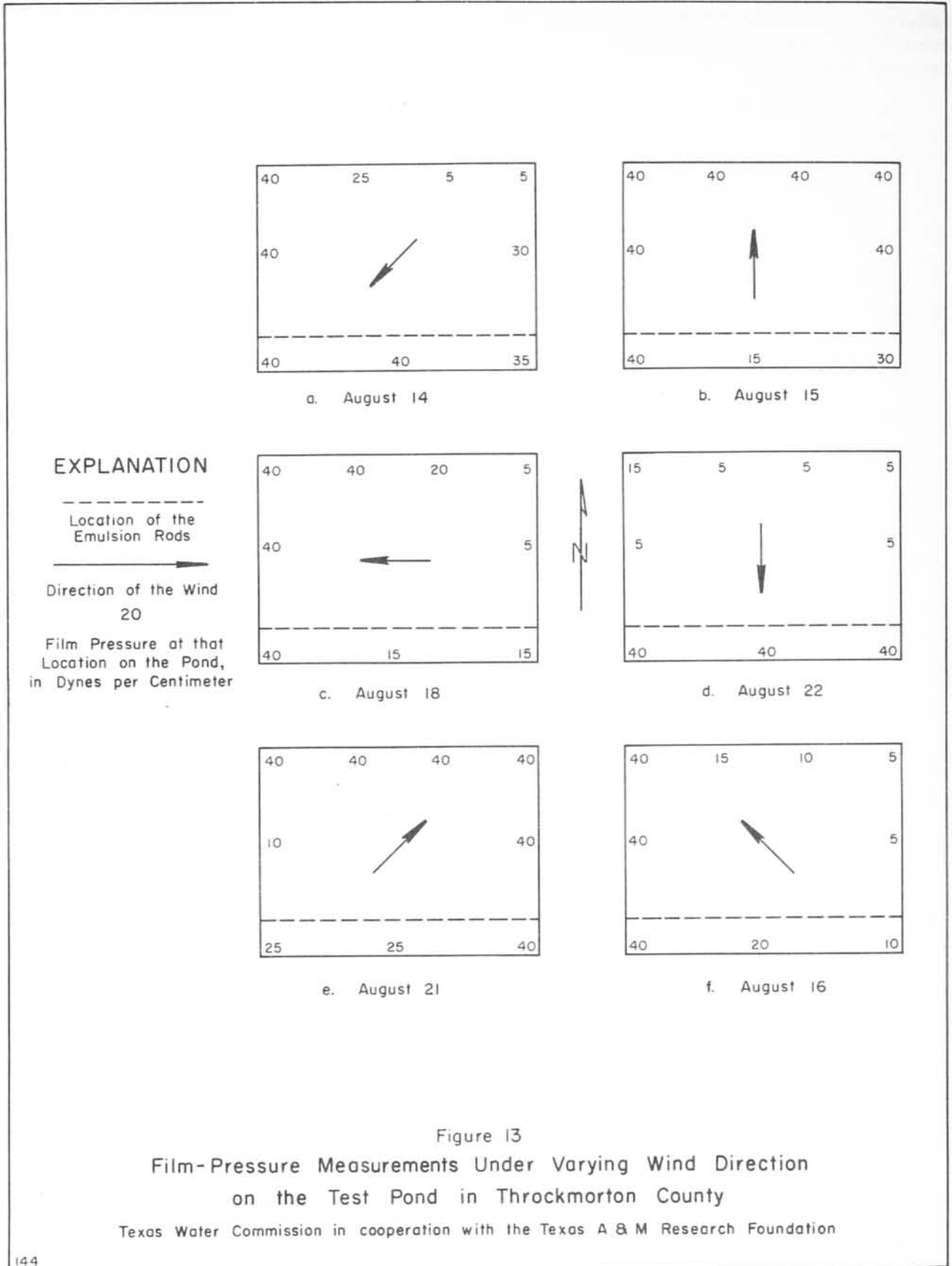

Figure 13
 Film-Pressure Measurements Under Varying Wind Direction
 on the Test Pond in Throckmorton County
 Texas Water Commission in cooperation with the Texas A & M Research Foundation

values. Estimates of film pressure were obtained at nine different points around the test pond. A reading of 40 dynes per centimeter represents a compressed film.

In the test on the twin ponds with the 211C emulsion, a water saving of 19 percent was indicated. High humidities and low wind velocities during the 11-day test period resulted in a water loss of 0.21 and 0.17 feet from the control and test pond, respectively. During the 9-day test period August 14 to August 23, in which 26 200-gram quantities of the emulsion were dispersed, the water saving was 17.7 percent or 0.03 foot. The 0.03 foot saving multiplied by the surface area (75 by 100 feet) gives a water saving equivalent to 1,686 gallons. This volume of water saved was realized with the addition of 11.45 pounds of emulsion. At current prices for ingredients, a pound of the emulsion would cost 37 cents and the total emulsion cost would be \$4.14. Thus, the price for saving 1,000 gallons of water would be \$2.45.

Figure 13 shows some representative film-pressure readings taken during periods of different prevailing wind directions in reference to the supply of emulsion. These film-pressure readings were obtained with a series of eight mixtures of lauryl alcohol and mineral oil which varied in film pressure from 5 to 40 dynes per centimeter.

Drops of these test solutions were placed on the water near the shoreline at points indicated by film-pressure values in the plots a to f in Figure 13. If the film pressure on the water was equal to or greater than the pressure value of the test solution, the drop did not disperse. Conversely, if the water pressure was less than test pressure, the drop dispersed on the water. Thus, through the use of the test solutions it was possible to establish a value of the water film pressure at the nine shoreline points of each plot.

It is evident that the prevailing wind must be blowing perpendicular to the line-source of emulsion if it is to provide a downwind cover at all points. Deviations from the perpendicular flow by 45 to 90 degrees result in poor film cover on one-half to two-thirds of the pond.

The quantity of wind travel during the day is known to be greater than during the night. The data in Table 16 provide some evidence as to the extent of this difference at the twin ponds. Wind travels were measured by an anemometer located about 11 feet from the water surface. The wind travel during the test period, August 14 to August 25, averaged 97.8 miles per day, or about 4.1 mph. Approximately 50 percent of this average wind travel was recorded during the 9-hour daytime period from 8 a.m. to 5 p.m., and the remaining 50 percent during the 15-hour period from 5 p.m. to 8 a.m. Thus, the overall 4.1 mph wind velocity becomes 5.43 mph for the daytime travel and 3.26 mph for the nighttime travel.

Test T8, March 13 to May 22, 1962

This period was devoted to a study on the rate of dispersion of three solid emulsion preparations from copper screen wire baskets. These baskets, which were used with some success for test T5, were 18 feet deep and 12 inches

in diameter. Copper screen was used in an attempt to reduce algal growth, as copper ions could possibly arise on the screen during residence time in the water.

The ratio of emulsifiers in emulsion 253, Table 3, was altered from 1:1 to 2:1 for emulsion 253A and to 5:1 for emulsion 253B. The quantity of combined emulsifiers was maintained constant. The three emulsions, 253, 253A, and 253B, had HLB numbers of 10, 12, and 14, respectively.

In the first test, March 13 to March 20, triplicate baskets of each emulsion were placed in the water. In 4 days residence time, 253B had been dispersed to the water. Essentially 5 and 7 days were required for the dispersion of 253A and 253, respectively. The increase in dispersion times (4, 5, and 7 days) followed a decrease in HLB number of the emulsion (14, 12, and 10). The testing took place during a period of high humidity and low evaporation rate-- 0.02 foot loss by the test pond and 0.03 foot loss by the control pond in 6 days. This water saving of 0.01 foot was obtained through the addition of a total of 4.18 pounds of emulsion.

The baskets were removed, cleaned, and again supplied with the three emulsions, as a single rectangular block per basket which on an average weighed 227 grams, and were placed in the water near the upwind shoreline of the test pond. The same order of dispersion as noted above took place, first 253B, then 253A, and last 253. However, the time required for complete dispersion of the 4.51 pounds used was 10 days instead of 6 for the first test. During this test period, 7 days were free of rain. Both the test and control ponds lost 0.07 foot of water; that is, there was no water saving by the emulsion.

Baskets again were cleaned, replaced in the water, and supplied with one block of emulsion per basket when they had been fixed in the water near the upwind shoreline. During this test period of 36 days, April 16 to May 22, a total 0.76 foot of water was lost from the test pond and 0.74 foot from the control pond. These losses were for 30 days uncomplicated by rain corrections. At the end of 36 days, two of the baskets containing 253 still contained some of the emulsion. Both 253A and 253B were completely gone in 34 to 36 days. A total of 4.12 pounds of emulsion was supplied to the baskets.

During this test run with the 253 emulsions, surface algae was the chief cause for the long period of dispersion. The emulsion blocks formed a gel within the basket, but the screen wire pores became clogged with algae debris and thus the emulsion did not disperse. The water levels in the ponds during this test were maintained at approximately 4 feet.

Test T9, June 22 to August 7, 1962

Following the termination of Test T8 (May 22, 1962), copper sulfate was added to the water to decrease algae growth. A fine-mesh seine was used to remove excess floating algal debris. Also, pond levels were raised to 5 feet to provide a cleaner water surface. After this clean-up procedure, emulsion 211C (in block form as the emulsions used in Test T8) was applied to nine copper screen baskets in the water on the test pond near the center dike--that is, near the south shoreline of the test pond. The nine blocks of emulsion (each

2 by 5-1/4 by 3/4 inches) weighed about 2 pounds, 1.5 pounds of which was Aquasave. Based on theoretical calculation, related to film movement as a function of surface wind travel, this quantity of chemical should have been stripped from the baskets in a maximum of 2 days with the prevailing wind existing at the twin ponds. A total of 2 bars per basket were added on June 22 and 23. Thereafter, no addition was made up to termination of the test. The emulsion went to a gel at the surface and sealed the wire mesh--a phenomenon which was reported earlier for emulsions in fabric meshes such as cheese cloth and surgical gauze but which did not occur with nylon mesh (approximately 1/8-inch mesh) material.

During the test period, 13 test days uncomplicated by rain showed evaporations of 0.21 and 0.25 foot, respectively, from the test and control ponds--or a water saving of 16 percent. However, film-chemical application was restricted by the screen mesh.

A similar run was started with 211B--a harder emulsion than 211C. Eighteen baskets were employed, instead of nine used for 211C, and the bar was cut into four pieces prior to addition. Results obtained from July 24 to August 7 were similar to those obtained with 211C. The screen mesh prevented escape of the film gel from the basket at the wind velocity which struck the baskets behind the 3-foot elevation of the center dike. As will be shown in a later discussion, the wind travel was less in the area of the baskets than on the downwind part of the pond. The magnitude of wind travel, as will be demonstrated, in the upwind half of the pond behind the dike was about 70 percent of anemometer recorded wind travel, and on the downwind half of the pond about 91 percent.

Emulsion 211B reduced the evaporation by 0.03 foot for 8 test days without rain corrections (control evaporation, 0.195 foot, minus test evaporation, 0.165 foot). This was a period of high humidity and rain showers, and the days when showers occurred were omitted from the evaluation because runoff water from rain into the two tanks was not the same. The saving of 0.03 foot, based on a control loss of 0.195 foot, represents a 16 percent water saving.

Test T10, April 22 to May 17, 1963

During the period April 22 to May 3, representing 11 days of evaporation, only 6 of the days provided readings free of corrections for rain or water withdrawal (1,000 gallons) for cattle use. During the 6 days, the emulsion preparation, 211C of Table 2, showed a water saving of 0.03 foot from a test pond with a starting water depth of 6.41 feet. Such a water saving on an 11-day basis covered by the test would be 0.055 foot or 3,091 gallons from a 0.172-acre water surface (75 by 100 feet). During the 11-day period, a total of 28.2 pounds of emulsion was added. The cost of the emulsion at current prices (48 cents per pound for Aquasave, 52 cents per pound for Arlacel 83, 52 cents per pound for Tween 40, and 75 cents per pound for copper oleate) would be 37 cents per pound considering that this emulsion contains 23 percent water. The addition of emulsifiers adds only 1 cent to the cost other than the 36 cents represented by 3/4 pound of Aquasave per pound of emulsion.

The 28.2 pounds of emulsion, at a cost of 37 cents per pound, represent an expenditure of \$10.43 to save 3,091 gallons of water from the pond, which had

0.172 or 1/6 acre of water surface. This gives a cost of \$3.38 per 1,000 gallons of water saved during a period where the calculated water saving amounted to 23 percent.

In the follow-up test period of May 3 to May 17, a total of 14 days during which 9 days of reliable readings were obtained, only 0.01 foot of water was saved through the addition of 19.4 pounds of emulsion. For the 1/6-acre pond, the volume of water saved would be 877 gallons with a chemical cost of \$8.19 per 1,000 gallons of water saved.

The test period from April 22 to May 17 was run with chunks of emulsion, 1-inch square and 1/4-inch thick, contained in a nylon mesh bag with plastic rod float (Figure 4) plus four 1-inch hollow plastic balls (similar to ping pong balls). The balls inside the bag with the emulsion served as a float, and also served as surface for wind contact, to provide a motion to the bags of emulsion and thereby enhance dispersion. The bags were tied by 1-foot lengths of twine to a stout cord stretched across the water surface at a distance of 3 feet from the upwind shoreline. A total of 26 bags, each containing 100 grams of emulsion, were placed on the water at the start of the test. Spent bags were replaced as needed.

Test T11, May 21 to May 31, 1963

The nylon bag, 4 inches wide and 12 inches long, containing a 1-foot plastic float (1/2 inch in diameter) as depicted in Figure 4, is a good system for application of the emulsion for test purposes. However, a more rigid container is desirable for continued application of film chemical. Cylinders of 1/8- and 1/4-inch hardware cloth, 2 inches in diameter and 12 inches long, were constructed and fitted with a cork float at each end. The floats, approximately 4 inches square by 2 inches thick, retained the wire cylinder and the emulsion on the water surface. As in the nylon-bag test above, these floating cylinders of wire mesh were tied to a stout cord near the upwind shoreline. Fifteen 1/8-inch-mesh and fifteen 1/4-inch-mesh cylinders, each containing 100 grams of emulsion 211C, were tied to a stout cord by a string bridle in a regular order, alternating the small and large mesh cylinders. The line of cylinders was then placed on the water near the upwind shoreline. During the test period, 1,650 and 1,300 grams, respectively, were added to replenish losses from the large and small mesh units. For all practical purposes, the 1/8- and 1/4-inch-mesh baskets served equally well as containers for the emulsion.

The test period of 11 days provided only 4 days in which readings were not complicated by rainfall. For these 4 days, the control pond lost 0.07 foot of water and the test pond lost 0.06 foot--a saving of 0.01 foot of water, or a 14.3 percent water saving.

This same setup was used to screen, or compare, a number of emulsion formulations for their dispersion rate: 161, 161A (without mineral oil), 168, 211C, 211C (without copper oleate), 212, 214, and 215 of Table 2. This experiment, from July 2 to July 15, 1963, was designed to find an emulsion with a more rapid dispersion rate than 211C.

Test conditions and weather data, as well as other experimental data obtained for this investigation, are recorded on Table 17. Emulsion compositions

Table 17.--Dispersion-rate studies of a series of solid emulsions^{a/} from floating 1/8- and 1/4-inch-mesh cylinders

Date 1963	Pond level		Water loss		Wind travel		Air temp.		Evaporation	
	Test (ft.)	Control (ft.)	Test (ft.)	Control (ft.)	Miles per day	Direction	Max.	Min.	2-foot pan (in.)	4-foot pan (in.)
7- 2: AM PM	6.49 --	6.22 --	-- --	-- --	-- 99.9	S --	93	66	--	--
7- 3: AM PM	6.46 6.45	6.19 6.18	0.03 .01	0.03 .01	-- 137.2	SW S	94	65	0.42	0.33
7- 4: AM PM	-- 6.41	-- 6.14	-- .04	-- .04	-- --	-- S	--	--	--	--
7- 8: AM PM	6.34 6.32	6.06 6.05	.07 .02	.08 .01	-- 591.2	-- --	-- 103	-- 69	-- 1.38	-- 1.96
7- 9: AM PM	6.31 6.30	6.04 6.02	.01 .01	.01 .02	-- --	-- --	-- 97	-- 78	-- .29	-- .41
7-10: AM PM	6.29 6.28	6.01 6.00	.01 .01	.01 .01	-- 182.2	-- --	-- 96	-- 61	-- .32	-- .40
7-11: AM PM	6.27 6.25	5.98 5.97	.01 .02	.02 .01	-- 197.9	SE SE	-- 97	-- 78	-- .37	-- .33
7-12: AM PM	6.23 6.21	5.95 5.93	.02 .02	.02 .02	-- 202.8	S S	-- 98	-- 59	-- .29	-- .55
7-15: AM PM	6.33 6.33	6.03 6.01	[Rain 1.40 in. 7-12 to 7-15 AM]		-- 375.0	-- --	-- 97	-- 68	-- .74	-- 1.13
7-16: AM PM	6.315 --	6.00 --	.015 --	.02 --	-- 134.5	S S	-- 98	-- 68	-- .31	-- .41
Total loss ^{b/}			0.395	0.420						

Remarks and Observations

Date

7- 2-63 AM Clear and still--S wind--Test started at AM
PM (No observations)

7- 3-63 AM Clear--SW wind--film cover except for center of pond
PM Clear--slight S wind--complete film cover

7- 4-63 AM (No observations)
PM Clear--strong S wind--good film

7- 8-63 AM Calm to gusty wind SW--2/3 film cover--chemical collection on NE shoreline
PM Calm clear--good cover

7- 9-63 AM Clear and still--N wind--foamy on NE and E sides
PM Gusty S wind--good film cover

7-10-63 AM Clear--still
PM Cloudy--gusty E wind--rain showers to the E--good film cover

7-11-63 AM Overcast--SE wind--good film cover
PM Clear--gusty SE wind--1/2 film cover

7-12-63 AM Clear--gusty SE wind--fair film cover
PM Clear--gusty SE wind--fair film cover

7-15-63 AM Clear--still--good film cover--1.40 inches rain 7-12 PM to 7-15 AM
PM Clear--still--good film cover

7-16-63 AM Clear--S wind--test ended

^{a/} Twenty-six floating cylinders were attached to line and placed on the water 3 feet from the south shore of test pond. Order was as follows (west to east along the string): eight 1/8-inch-mesh cylinders, emulsions 161, 161A (no mineral oil), 168, 211C, 211C (no copper oleate), 212, 214, and 215--eight 1/4-inch-mesh cylinders, emulsions 212, 214, 215, 161, 161A (no mineral oil), 211C, and 211C (no copper oleate)--five 1/8-inch-mesh cylinders, emulsions 161, 161A (no mineral oil), 168, 211C, and 211C (no copper oleate)--five 1/4-inch-mesh cylinders, emulsions 161, 161A (no mineral oil), 168, 211C, and 211C (no copper oleate).

One hundred grams of emulsion per cylinder--all cylinders except small mesh 215 refilled on 7/8/63--none were completely empty.

^{b/} For 12 days AM to PM--excluding 7/12 to 7/15 dates.

are provided by Table 2; also, earlier dispersion rates obtained on a large lake at College Station are recorded by the data of Table 2. The screening tests at College Station indicated a similarity in the dispersion rates of these emulsions. The twin-pond dispersion studies in the 1/8- and 1/4-inch wire mesh cylinders, 2 inches in diameter and 12 inches long, showed that dispersion rates of the emulsions were essentially the same. Likewise, size of the wire mesh, 1/8 inch versus 1/4 inch, did not alter dispersion rates except for emulsion 215 when contained in the 1/8-inch-mesh cylinder. The cylinder provided area for wind contact, therefore motion was given to the cylinders containing the emulsion, and this aided dispersion of film chemical from the emulsion.

Twelve test days free of rain demonstrated a saving of 0.025 foot (control-pond loss, 0.420 foot, minus test-pond loss, 0.395 foot)--essentially a 6 percent water saving. This water saving was obtained during a test period when the film coverage varied from 50 percent to complete. During this test, the possible "nonidentical twin character" of the two ponds, as related to egress of wind to the water surface and to rate of dispersion of emulsion, could have been a contributing factor. An 11.8 percent increase in figures for control-pond evaporation, a correction derived from the emulsion test in wire-mesh cylinders, creates a more favorable water-saving picture; namely, a control evaporation of 0.47 foot and a test evaporation of 0.395 foot. The water saved on this basis amounts to 0.065 foot instead of 0.025 foot--or for a 1/6-acre pond, such as the test pond, 3,653 gallons of water saved instead of only 1,387 gallons.

Test T12, July 31 to August 19, 1963

This test period was devoted to a study of the evaporation-retardant capabilities of a liquid emulsion^{7/} supplied to the test-pond water surface from eight drippers or jets along the south shoreline. The eight jets were supplied from a common reservoir through a 12-foot length of 1/4-inch inside diameter Tygon tubing which in turn fed into a 3/4-inch water pipe. The jets were fitted in T's which were used to connect 10-foot sections of pipe. The emulsion supplied by the 1/4-inch tubing entered the center of the length of the 3/4-inch pipe system. A jet was placed 5 feet on either side of the emulsion supply and at 10-foot intervals thereafter, so that four jets were located on each side of the supply tube.

The steel container for the emulsion was fixed in a level position on the center dike so that the bottom of the container was 39 inches from the water level in the tank. The container, which was 22 inches tall with an inside diameter of 16 inches, was kept filled to a level of 6 to 12 inches to minimize the effect of change in liquid flow with change in liquid head. By this procedure the average emulsion head was approximately 4 feet. This system was essentially the same as the unvented jet or manifold system previously described.

With this distribution system, in which a 12-foot length of hose served as a flow-regulating device, 1.3 gallons of an emulsion containing 9.87 percent

^{7/} Composition of emulsion given in footnote^{4/} on page 41.

Aquasave was metered to the water per day. Thus for the 19-day test period, in which there was no rain or water removal for cattle, a total of 24.7 gallons of emulsion (7.84 pounds per gallon) was added. This volume of emulsion, representing 19.1 pounds of Aquasave (24.7 gallons times 7.84 pounds per gallon times 9.87 percent Aquasave), 0.52 pound of Tween 40, and 1.8 pounds of mineral oil, represents a cost of \$10.34. The saving of 0.09 inch of water as on the 1/6-acre pond (75 by 100 feet) is equivalent to 5,121 gallons of water--or a cost of \$2.02 per 1,000 gallons of water saved.

The metering of a properly prepared emulsion generally is free of operational difficulties other than those mentioned earlier in reference to variable flow rate of different batches of emulsion. It is felt that much of this difficulty could be removed by a uniform preparation procedure. A constant-head supply system (Figure 14) also would provide a more uniform flow of liquid to the water surface. The constant-head dripper of Figure 14 is different from that of Figure 3 in only one important respect: the addition of an internal air-vent tube as shown for the emulsion dripper. The air vents through the small tube of the emulsion unit, and the emulsion flows through a larger tube. This prevents foaming which occurred with the single-tube, constant-head device (Figure 3) used for solvent solutions of Aquasave.

The components of the emulsion-dripper system should be protected by insulation from heat and cold to minimize temperature changes. The supply tank itself could be provided with a white insulation, and the 1/4-inch flow-regulating hose or metal tubing as well as the 3/4-inch distribution pipe could be either buried or insulated. Only the ends of the short sections of 1/4-inch hose attached to the jets should be free to drip on the water surface. In fact, the 3/4-inch distribution pipe could be placed in the water if the metal jets were lengthened to extend above the water surface. The longer metal jets could be bent into the form of a "U" so that solution would drip onto the water surface. These metal vent tubes could be bent or inclined to correct for differences in flow. With the longer metal jet tubes it would be necessary to increase the elevation of the emulsion tank.

The liquid-emulsion system has advantages over the solvent system as to cost, and as to freedom from clogging. For solvent-solution addition, the small capillaries are clogged readily by small particles of foreign matter. However, the emulsion unit that uses 1/4-inch jets and flow-regulating tubing is free of such a clogging problem. A uniform rate of flow from one preparation to another is the most serious problem. However, this could be corrected even during application by changing the elevation--either lowering or raising--of the emulsion supply system. Observation of rate of discharge by a sight glass on the supply tank would be an aid in calibrating the rate of flow of a new emulsion preparation. In fact, further research may show the feasibility of producing emulsions of constant-flow characteristic.

The addition of a wind vane to close a supply valve during periods of unfavorable wind direction would add economy. Furthermore, the cost of such a distribution system is not excessive, and multiple units could be used. The use of plastic pipe instead of iron pipe also would reduce the cost of the unit. A drum, 5 to 55 gallons, with a reinforced false bottom welded 6 inches from the actual bottom of the drum would be adequate for an emulsion container and constant-head device (Figure 15). A 1/4-inch section of water pipe would serve as an internal air vent if it were welded to the false bottom, extending

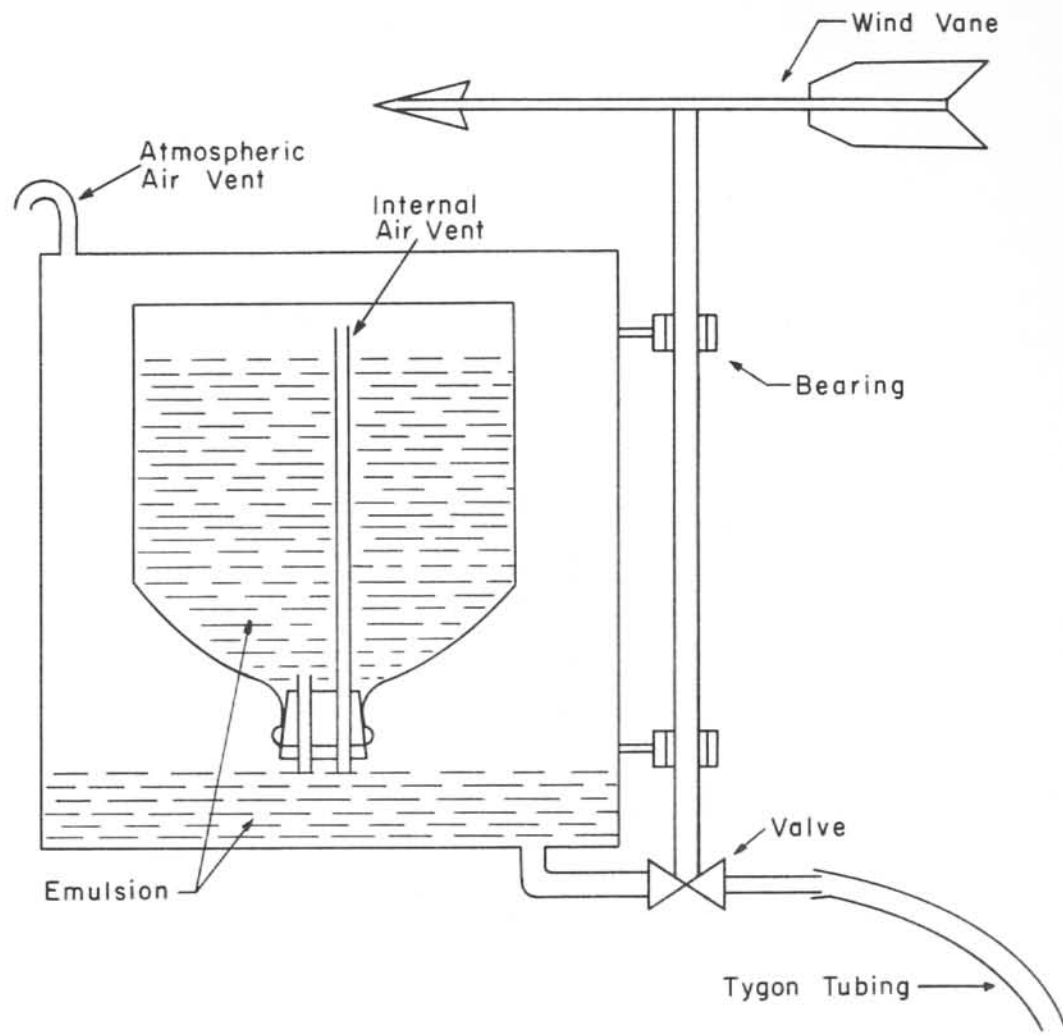

Figure 14
 Constant-Head Device for Dispensing Liquid Emulsion
 Texas Water Commission in cooperation with the Texas A & M Research Foundation

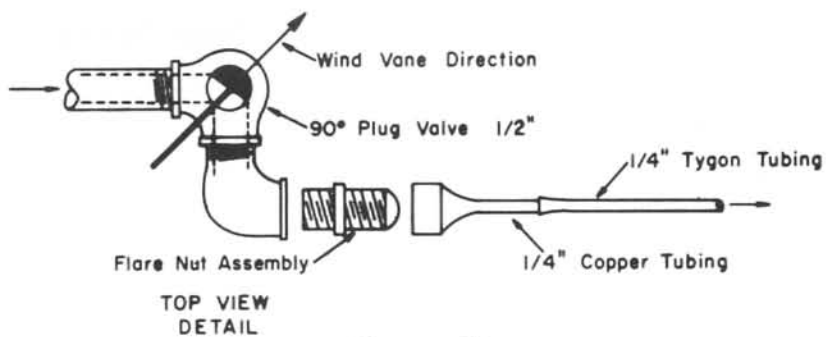
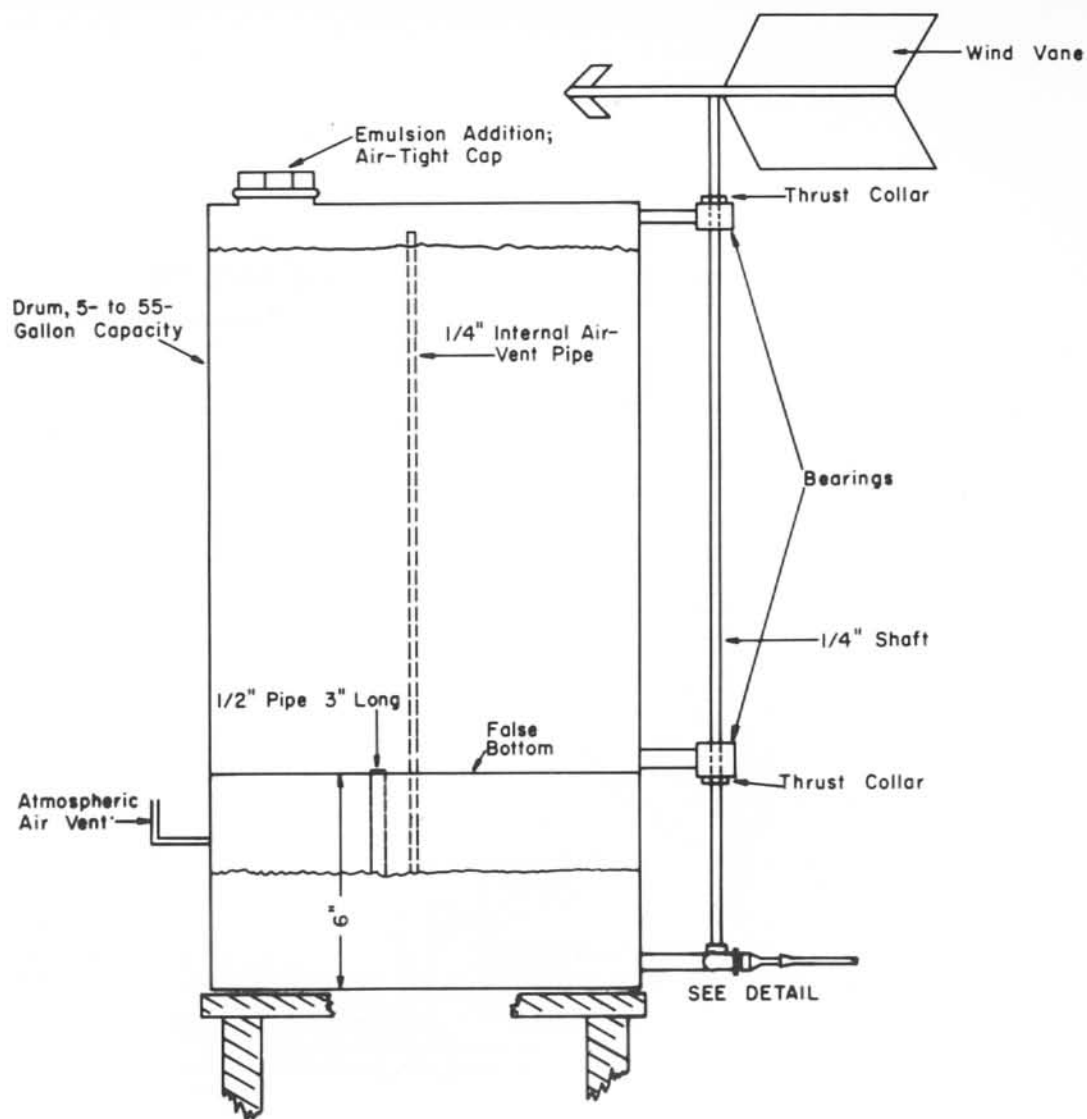

Figure 15
Operational Constant-Head Device for Dispensing
Liquid Emulsion

Texas Water Commission in cooperation with the Texas A & M Research Foundation

through it for about 3 inches and upwards to 1 inch from the top of the drum. A piece of 1/2-inch water pipe welded to extend slightly more than 3 inches through the false bottom and flush with the top of the false bottom would serve as a means of delivering emulsion to the 6-inch compartment below--which in turn would be filled and maintained at a depth of 3 inches with emulsion. An air-tight cover for the supply drum is essential for the proper working of the unit. A 1/4-inch inside diameter vent pipe welded into the side of the tank just below the false bottom would complete the emulsion supply tank which could be filled up to at least 2 inches from the top of the drum. A 1/2-inch valve fixed in the side of the drum, 1 inch from the bottom, would afford a means of shutting off flow if necessary. The 1/4-inch inside diameter flow-regulating hose or pipe of desired length would be attached to the valve, and to the center of the 3/4-inch distribution pipe which could be fitted with jets at 10-foot intervals.

The fabricated drum and auxiliaries for this simple distribution system can be purchased for \$50 to \$60, and with proper maintenance should last for a minimum of 5 years. At a flow rate of 1.3 gallons per day, supplying approximately 1 pound of Aquasave per day, the supply contained in the tank (exclusive of the 3-inch supply of constant head in the bottom) should provide a constant flow of emulsion to the water surface for a period of at least 30 days.

The ultimate in controlled addition of the liquid emulsion would be to utilize a positive displacement pump driven by a "wind mill" to meter emulsion to the 3/4-inch pipe distribution system rather than the 1/4-inch tubing. Such a duplex or twin-piston displacement pump, a "mimi pump" produced by the Milton Roy Co., was used in laboratory studies. With at least a 2-foot head of liquid on the intake side of the pump, the check valves functioned properly and emulsion was metered from the unit at a constant rate. This pump was driven by a 1/15-horsepower motor attached to a 60:1 gear-reduction system which drove the displacement pistons of the pump. These pistons were 1/8 inch in diameter. Facilities were provided for changing stroke length of the piston--a feature which permitted further regulation of the rate of emulsion flow.

Test T13, August 20 to September 10, 1963

This twin-ponds test resulted from observations made on the dispersion of emulsion 211C from 1/8-inch-mesh rectangular baskets (10 feet long by 4 inches wide, 12 inches deep) in a large lake (Tank J) on the experimental Ranch at Seymour. The upwind shoreline of the lake was unobstructed as to egress of wind to the water--that is, no embankment near the water edge. Four of the above mesh containers were fixed in 6 to 9 inches of water near the lake shoreline at 10-foot intervals, with the 10-foot length of the baskets normal to the prevailing wind. Two pounds of emulsion preparation 211C with copper oleate and two pounds of 211C without copper oleate were placed in alternate baskets. The film streaming from these units, driven by a surface wind of about 5 mph, was spread and maintained across the 300-foot downwind length of the water. Spreading normal to the film travel was such that the width of coverage was 80 to 100 feet.

A spread of 50 feet normal to the wind could be realized from each basket as determined by observations on the last one. Therefore, the baskets were spaced every 50 feet and film coverage was maintained over a 200-foot width of

water for downwind length of 300 feet. This is approximately 1.3 acres of water surface covered with film. With modest wind travel, the film was maintained, but streaking was apparent when the wind approached 10 mph.

Six of the rectangular baskets were placed on the test pond of the twin ponds--two each in the water parallel with the north and south shorelines, one each in the water parallel with the east and west shorelines. Two grams of emulsion 211C was placed in each of the baskets, which were numbered A, B, C, D, E, and F in a clockwise direction starting with the one basket along the west shoreline as A. The prevailing wind direction during the test period was SE to SSE (south-southeast). Table 18 provides the data relating to this test run, which was designed to note the rates of dispersion of a given quantity of emulsion from different dispensers in the water along different shorelines, and to correlate dispersion data to dike height versus wind travel on the water proper.

During the test period of 21 days, the test pond lost 0.385 foot of water as compared to 0.420 foot from the control pond--a saving of 0.035 foot of water through the addition of 24 pounds of emulsion representing a total cost of \$8.68. For the standard 1/6-acre pond, the volume of water saved would calculate to 1,967 gallons and the cost would be \$4.41 per 1,000 gallons of water saved. However, not all of the chemical had been consumed, and the experiment was oriented toward time required for essentially complete release of the emulsion from the basket rather than the maintenance of an effective film.

Table 18 shows that not all baskets needed replenishment at the same time, after the starting date. Basket D on the east side was depleted of emulsion in 5 days, whereas C was not emptied until a lapse of 17 days on the water. These data suggest that a SE or SSE wind removed the emulsion from D, and surrounded C with a film preventing dispersion. After 5 days the wind shifted more to the SW to W, and D as well as C was protected; F was depleted. The rapid dispersion of C in 3 days (September 6 to 10) is suggestive of a wind shift to the east. It was noted that a good film cover was maintained on the water when the baskets were not empty; a poor cover existed on September 3, before the addition of emulsion to A, B, and E.

Baskets E and F, along the south shoreline (center dike), would be the most sheltered from wind out of the south. The center dike has the highest profile with respect to the water, and a wind from the south would strike the water further from this shoreline than would wind from other directions. Ease of egress of the wind to the water increases in the order of south, east, west, and north for wind blowing from those respective directions. Dike heights in respect to the surrounding terrain decrease in the same order. Thus baskets E and F placed near the south shoreline, during a period of 5-mph surface wind travel of 2 to 3 mph. Under this condition the emulsion disperses at a rate demanded by the 2 to 3 mph wind. However, further out on the water the wind velocity may be 5 mph, and as a result a compressed film is not maintained. The effect of wind velocity on film-chemical movement, and the amounts of film chemical required were discussed earlier in this report. Based on the average wind travel during the test period, 4.3 mph near the 100-foot shoreline of the test pond, and with a film movement of 3.4 feet per 100 feet of wind travel, a total of 768.5 feet of film-chemical travel per hour would have been realized. In other words, the 75-foot downwind width would have been swept free of slightly more than 10 film covers per hour or 240 film covers per day. The 1/6 acre

Table 18.--Evaporation studies with solid emulsion
211C in 1/8-inch-mesh baskets^{a/}

Date	Pond level (ft.)		Water loss (ft.)		Emulsion addition (pounds) in basket						Wind travel (mpd)
	Test	Control	Test	Control	A	B	C	D	E	F	
8-20-63	6.455	6.23	--	--	2	2	2	2	2	2	76.0
8-21	6.43	6.20	0.015	0.030							64.0
8-23	6.39	6.16	.040	.040							251.5
8-26	6.33	6.10	.060	.060				2			309.6
8-27	6.31	6.07	.020	.030							100.6
8-28	6.28	6.04	.030	.030							132.3
8-29	6.25	6.02	.030	.020						2	125.4
8-30	6.25	6.01	.000	.010							117.0
9-2	6.20	5.96	.050	.050							368.8
9-3	6.17	5.93	.030	.030	2	2				2	109.3
9-4	6.16	5.91	.010	.020							96.0
9-6	6.12	5.87	.040	.040			2				182.6
9-9	6.08	5.83	.040	.040							262.5
9-10	6.06	5.81	.020	.020	1	1	2	2			60.9
Total			0.385	0.420							

	Average	Maximum	Minimum
Evaporation, inches			
2-foot pan	0.25	0.33	0.21
4-foot pan	.35	.48	.23
Air Temperature, °F	99	104	--
Air Travel, mph	4.3	5.5	2.5

^{a/} 10 feet long by 4 inches wide, 12 inches deep--immersed 6 inches in water of test pond.

per film cover times a total of 240 changes is equivalent to 40 acres of water surface. Using the theoretical amount of Aquasave needed to cover 1 acre, 0.02 pounds, this means that 0.8 pounds of Aquasave must be released per day at the upwind shoreline. Using the experimental figure of 0.05 pounds per acre, the 0.8 pounds per day becomes 2.0 pounds per day. Thus for the 21-day test period a total range of Aquasave of 16.8 to 42 pounds is indicated. Only 24 pounds of emulsion, which represents 18 pounds of Aquasave, was added during the 21-day test period. These comments suggest that surface wind velocity is not the same where measured as immediately adjacent to the emulsion preparation on the water surface. In all of the experiments with emulsion 211C, as well as others, extra motion imparted to the dispensers during filling or replacement resulted in excess release of film chemicals--not as particles but as a liquid film. Thus motion, applied either by application or by prevailing wind velocity, is necessary for the use of solid emulsion for evaporation control.

Test T14, September 12, 1963

A comparison of the wind-velocity recordings by the anemometer on the center dike between the twin ponds, and the 2-foot anemometer at the weather station, some 100 feet WSW of the SW corner of the control pond, showed that for the years 1959-60 and 1961 the weather station wind-travel readings were on an average only 60 percent of the readings obtained by the dike anemometer. The anemometer cups at the center of the dike were 82 inches above the top of the dike.

On September 12, two small, essentially identical directional-vane anemometers, A_1 and A_2 , were calibrated in an open area, and the ratio (A_1/A_2) of the wind travels as recorded by the two units in 10-minute tests was 1.01. A_2 was placed on a support so that the center of the wind vane was 82 inches from the dike, and was oriented with the vane normal to the prevailing wind. A_1 was placed in a similar fashion--first 38 inches and then 18 inches from ground level of the dike. For each position of A_1 , duplicate wind-travel readings were taken for both A_1 and A_2 , and the ratio of wind travel of A_1/A_2 was calculated for the duplicate tests. Ratios were needed because wind travel was not constant throughout the tests, and because only two anemometers were available for the runs. These data, Table 19, show a drop in wind velocity of approximately 30 and 43 percent, respectively, at the 38- and 18-inch levels when compared to the 82-inch level as 100 percent.

Traverses of the water surfaces of first the control, then the test pond also were made with anemometer A_1 , with A_2 still at the 82-inch level. For the traverses, A_1 was fixed to a cork float which, in turn, was fitted with short bridles on opposite sides of the float. Long lengths of fishing cord were attached to each bridle. This arrangement permitted the pulling of the anemometer, vanes normal to the prevailing wind, across the water surface in the direction of the prevailing wind. Duplicate traverse readings, with corresponding A_2 readings, were taken for a 10-minute traverse of the anemometer from one shoreline to the other and then back. Similar 10-minute traverses also were made for both the upwind and downwind halves of each pond.

The ratios (A_1/A_2) for the traverses varied some during the test period, with a SSE wind ranging from a low of 1.59 mph to a high of 7.95 mph. However, data obtained by this traverse technique shows that the control and test ponds,

Table 19.--Wind velocities on water surfaces of control and test ponds

Center dike location (elevation from dike, inches)		Wind travel ^{a/} (ft. per 10 min.)		Average ratio (A ₁ /A ₂)
Anemometer A ₂	Anemometer A ₁	A ₂	A ₁	
82	82	6,396 5,244	6,222 5,287	0.989
82	38	7,002 6,051	4,605 4,440	.693
82	18	6,162 4,699	3,335 2,790	.563
<u>10-min. Water-Surface Traverses With A₁ On Float On Water</u>				
Control-Pond Traverses				
120 ^{b/}	Complete (Full) Surface	5,404 4,733	4,008 3,393	0.732 ^{c/}
120	Upwind Half of Surface	4,202 3,345	3,041 2,653	.754
120	Downwind Half of Surface	4,316 5,884	3,180 3,892	.693
Test-Pond Traverses				
120	Complete (Full) Surface	2,535 2,135	1,480 1,817	0.706 ^{c/}
120	Upwind Half of Surface	2,435 1,394	1,712 930	.690
120	Downwind Half of Surface	2,869 2,387	2,391 2,384	.909

^{a/} SSE prevailing wind.

^{b/} A₂--elevated 82 inches above dike plus 38 inches to water surface.

^{c/} Using the sum of upwind and downwind runs and dividing by two gives two more equal full-traverse averages which when added to the full-traverse figure and divided by three gives an overall average, full-traverse value of 0.726 for the control pond and 0.768 for the test pond.

respectively, receive only 72.6 percent and 76.8 percent of the SSE wind recorded by the anemometer on the dike. The control pond also is more uniform in wind distribution as to upwind and downwind halves. The side of the test pond sheltered by the center dike receives an average of 70.6 percent of the wind recorded by the dike anemometer, whereas the downwind side receives an average of 90.9 percent. These data are for only one direction of wind flow--SSE. A wind from the north, coming over the low-profile dike on the north shore of the test pond and then over the center dike and across the control pond, would present a different picture; based on the above results, water in the test pond would still receive much more wind than water in the control pond.

Information on wind velocity is critical in evaluating water savings obtained and the dispersion of an evaporation retardant from a solid emulsion in an upwind container. We may use the data of Table 18 as an example. During the 21-day test period, a total of 0.035 foot of water was saved, which is equivalent to 1,967 gallons of water per 1/6 acre or 11,802 gallons per acre. The average wind velocity recorded by the dike anemometer was 4.3 mph. Using the data in Tables 18 and 19, the control pond received a wind blowing at 3.1 mph (0.726×4.3), and the test pond (full pond traverse average 0.768×4.3) received a wind of 3.3 mph. This small difference of 0.2 mph is minor. However, if we consider that the downwind half of the test pond receives a wind of 3.9 mph (0.909×4.3), the difference there is 0.8 mph and of greater importance, especially as this half of the water is being supplied by film chemical created by a wind demand of only 3.0 mph (0.706×4.3) in the upwind half of the test pond.

The controlled-chamber studies (Table 11) show that the average change in control evaporation, in the range 2 to 4 mph wind travel, at 100°F and 40 percent relative humidity is 3,125 gallons per acre per day for a change in wind travel of 1 mph. A comparable figure for the test evaporation is approximately 1,500 gallons. Using the control figures and other data of Table 11 to correct the wind velocity of 3.1 mph of the control pond to 3.9 mph, it can be shown that the evaporation from the control pond should be 11.5 percent greater than was indicated by the experimental data of Table 18; the 0.420-foot control loss should have been 0.468 foot. The addition of 0.048 foot to the experimental saving of 0.035 foot provides a total saving of 0.083 foot of water--or 4,694 instead of 1,967 gallons of water. On this basis (4,694 gallons), the cost for saving 1,000 gallons of water from the 1/6-acre pond drops from \$4.41 (prior to wind correction) to \$1.85 per 1,000 gallons. This would be approximately 30 cents per 1,000 gallons for a 1-acre pond.

At lower wind velocities, in the range of 1 to 3 mph, the wind differences over a control and test body of water are even more important because evaporation changes are much greater per unit increase or decrease of wind velocity.

DISCUSSION OF RESULTS

Three methods of applying a chemical film to the water surface of a small reservoir were tested on the twin ponds located in Throckmorton County 20 miles south of Seymour. In all of these tests, the active evaporation retardant was a 1:1 mixture of hexadecanol and octadecanol. This basic chemical was added as a solution in isopropanol, as a solid emulsion, and as a flowable liquid emulsion.

Metering of the fatty alcohol solution in isopropanol was accomplished by capillary tubes attached to constant-pressure tanks. This application procedure has limitations both from the practical aspects and from the standpoint of economics. The fine regulating capillaries had a tendency to clog with small particles of foreign matter which found their way into the dripper cans and also by crystals of the fatty alcohol which formed when the solution was cooled to below 54°F by ambient conditions. A 1:1 mixture of hexane and isopropanol obviated the temperature effect until the solution reached a temperature of freezing--32°F. At current prices for the fatty alcohol (48 cents per pound) and for isopropanol (72 cents per gallon), the addition of a 20 percent by weight solution represents the addition of essentially 48 cents worth of alcohol for each pound or 48 cents worth of evaporation retardant. In essence, the price for saving a unit volume of water is doubled by the use of solvent.

Solid emulsion 211C, as well as certain others of Table 2, possess the ability to release the film chemical as needed--that is, as the film around the emulsion is carried away by the prevailing surface wind. Neither large particles of pure fatty alcohols, or fatty alcohol mixtures (such as Aquasave 1-SD used in these field tests), nor emulsions disperse when they are surrounded by a compressed film. However, the solid-emulsion preparation has the added advantage that it can disperse or supply film chemical as demanded by higher surface wind velocities--a property not possessed by the nonemulsion form. Thus, emulsions contained in a coarse mesh basket near the upwind shoreline--either as a floating unit or as a basket placed in the water of sufficient height to extend 6 inches above the water level--afford a means of adding film chemical as a function of the wind velocity by a nonmechanical means.

The term "in the water near the upwind shoreline" as the position for the emulsion floats or baskets must be reviewed in terms of the nature of the pond or reservoir. An upwind shoreline protected by a dike or embankment prevents wind egress to the water for some distance from the shore. As such, emulsion dispensers placed too near the shoreline will not be subjected to wind travel existing further downwind on the water. This situation would create a dispersion rate at low wind travel to fulfill film-chemical demands on a body of water subjected to a higher wind travel; thus, a compressed film is not assured on the water surface. To obviate this effect, it is necessary to place the floats an adequate distance downwind so that the prevailing, unsheltered wind contacts the emulsion containers. The lower the profile of the embankment, the nearer the emulsion floats may be placed to the upwind shoreline.

One pound of emulsion 211C, with no mineral oil, contains essentially 0.75 pounds of Aquasave which costs 36 cents. The emulsifiers used in the preparation add essentially 1 cent to the cost, so that total cost is 37 cents per pound of emulsion. The "copper oleate," prepared from Ivory flakes by the addition of copper sulfate, prevents growth of algae on the emulsion while it is in the dispenser. A chief feature in reference to dispersion of the emulsion onto the water from baskets is to have the baskets made of 1/8- to 1/4-inch wire mesh. This permits the film to escape and also reduces the number of times a basket must be removed from the water and cleaned. The cleaning would be necessary in a pond with a heavy algae growth. In clean water, removal for clean up would be a minor consideration. One word of caution is needed in reference to the storage of emulsion--it should be kept in a cool place (below 85°F) and in a sealed container. Cool storage conditions prevent the fusion of emulsion blocks

due to heat, and a sealed container assures retention of moisture content of the emulsion and thus uniform dispersion when placed on the water.

The liquid emulsion of Aquasave, although variable in flow characteristics if not prepared by a constant procedure, offers the greatest potential for use on the small ranch or farm pond. Simple constant-head drippers, based on the details shown by Figure 12, equipped with a suitable length of 1/4- or 5/16-inch hose for a given or variable emulsion head can meter the emulsion onto the water as a single source or can meter the emulsion into a pipe distribution system. The cost of both emulsion and constant-head dripper units is modest. The wind vane activated valve is optional to the operation of the unit; however, it would add economy to a water-saving program because film chemical would not be added during periods of adverse wind direction.

Table 20 shows that about 20 percent water saving is possible by four methods of film-chemical application: as a solution in isopropanol, as a solid emulsion housed in a floating nylon mesh bag, as a liquid emulsion metered to the water, and as a powdered mixture placed in copper screen wire baskets. All of these applications are at the "prevailing upwind" shoreline. Comparison of these approximately 20 percent water savings with the 40 to 50 percent savings obtained with these same preparations in small-tank laboratory studies (2.77 square feet of water surface) indicates that only 40 to 50 percent effective pond coverage was obtained by "upwind addition" of film chemical in the field tests. The application efficiency column of Table 20 utilizes such a comparison; that is, the 50 percent water saving obtained in small containers is taken as 100 percent efficiency. On this basis, a process of application that provides a 20 percent water saving has a 40 percent application efficiency.

This "application efficiency" expression is in keeping with film-pressure measurements made on the twin pond (Figure 13). From these data it is easy to visualize only 50 percent water coverage when a single shoreline is used for film chemical addition. That is, variable prevailing winds in reference to the shoreline of application can create conditions of essentially zero to 100 percent film cover.

The suggested use of either the liquid-emulsion or solid-emulsion method of adding film chemical to the water surface of small ponds is subject to some theoretical objections. The presence of impurities, such as solvents, emulsifiers, soluble packages for the powdered form, etc., weaken the film--or produce holes in the film. In fact some evidence for this may be apparent in the data of Table 20. The powdered mixture of hexa- and octadecanol supplied to the copper screen wire baskets in a soluble plastic bag produced a 20 percent water saving with the addition of 2 pounds of film chemical in 8 days. Here the plastic bag dissolved rapidly and was removed from the dispenser area. Thus, essentially pure evaporation retardant dispersed from the screen basket for the remainder of its residence time in the basket. The 2 pounds of film chemical per 8 days, or 0.25 pounds per day, may be compared to the 1 pound of Aquasave added per day for 19 days as a liquid emulsion with essentially a 20 percent water saving. These data suggest that the powdered form was essentially 4 times as effective as the emulsion form. The validity of this comparison must be established by further investigation. Furthermore, the fine screen wire dispensers are subject to malfunction due to clogging by algal growths in the

Table 20.--Evaporation costs versus method of application on twin-pond facilities

Application method	Test days	Evaporation loss (feet)		Water saved		Cost per saving 1,000 gallons		Application efficiency (percent ^{a/})
		Control pond	Test pond	(feet)	(percent)	1/6 acre	1 acre	
Solution in isopropanol	70	1.02	0.79	0.23	22.5	\$5.00	\$0.83	46.0
Do.	73	1.39	1.15	.24	16.5	8.45	1.41	33.0
Solid emulsion 211C in nylon bags	9	.21	.19	.04	19.0	2.45	.43	38.0
Liquid emulsion	19	.45	.35	.10	22.2	1.82	.30	44.4
Emulsion powder in soluble bag in copper mesh basket	8	.20	.16	.04	20.0	1.02	.17	40.0

^{a/} Based on small-tank water saving of 50 percent as 100 percent efficiency.

water or on the water surface. Because of the ease of application, in reference to small ranch and farm ponds, both the solid emulsion contained in large mesh holders (floats or dispensers fixed in the water near the shoreline) and the liquid emulsion, supplied by a nonmechanical constant-delivery system, are currently considered as logical means of film-chemical addition.

The floating-dispenser or raft concept for the application of the film chemical is not new. However, the solid-emulsion concept of the floating dispenser or fixed dispenser is an advance in the art. As pointed out earlier, both Drew (1958) and Dressler^{8/} have suggested the use of emulsion or suspensions as a means of applying film chemical. In fact, the patent of Dressler points to the use of oleyl alcohol in an emulsion as an example--not hexa- or octadecanol. Oleyl alcohol is a straight chain alcohol containing one double bond whereas cetyl alcohol (octadecanol) is a straight chain saturated alcohol.

In view of the similarity in the patent of Dressler and the liquid-emulsion system developed in this investigation, it may be necessary to obtain a legal ruling as to possible infringement which may be involved if the liquid emulsion of a mixture of hexa- and octadecanol is applied as suggested in this presentation; namely, gravity-flow addition through a tube of small diameter (1/4 to 5/16 inches) to control or regulate the flow to the water surface. The concept of a flow-regulating hose, and the production of a stable liquid emulsion that requires no agitation while in the supply tank are developments of this research program. The patent of Dressler is directed toward suspensions to a large degree, but is all inclusive in that emulsions are suggested without specific field trial example given by the patent on an emulsion. Regardless of patent or royalty aspects of the liquid emulsion, the investigators feel that this process has merit for the small ranch and farm pond--that is, for ponds ranging from less than 1 up to 2 or 3 acres.

This report on the use of the fatty alcohols, hexa- and octadecanol, or the reported emulsion preparations (which contain cosmetic grade emulsifiers) does not imply an endorsement of the process by the Food and Drug Administration. However, the control pond, receiving these preparations at intervals over a period of 4 years, has provided water for cattle use without apparent damage to them. Likewise, application of emulsion 211C to a large pond on the Texas Agricultural Experimental Ranch at Seymour for a period of 2 weeks gave no indication of adverse effect on cattle consuming water from the pond.

ECONOMICS OF WATER EVAPORATION CONTROL ON SMALL RANCH AND FARM PONDS

The ranch and farm pond presents an entirely different economic picture than that presented by large reservoirs. Furthermore, ranch and farm ponds of the same water-surface area do not present the same cost figures for saving a unit volume of water. The small test pond, about 1/6-acre, used in this study gave costs ranging from \$1.02 to \$8.45 per 1,000 gallons of water saved. Eliminating the high costs experienced with the solvent-addition method, the range

^{8/} Dressler, R. G., 1959, Method for retarding evaporation of water from large bodies of water: U. S. Patent No. 2,903,330.

is from \$1.02 to \$2.45 per 1,000 gallons of water saved. Assuming that the same quantity of chemical would be adequate for a 1-acre pond (100 feet of shoreline normal to the prevailing wind by 435.6 feet long), the latter figures calculate to a range of 17 to 43 cents per 1,000 gallons of water saved.

Costs presented in Tables 10 and 11, derived from experiments with the controlled-environment chamber, provide a figure of about 20 cents per 1,000 gallons of water saved--a cost which is essentially based on 100 percent application efficiency (Table 20). In view of these data obtained in the controlled-environment chamber, actual water-saving costs on a 1/6-acre pond presenting 100 feet of shoreline normal to the prevailing wind, with a 50 percent process efficiency, would be closer to \$2.00 per 1,000 gallons of water saved. For a 1-acre pond that exposes 100 feet of shoreline normal to the prevailing wind, the cost would be 40 cents per 1,000 gallons of water saved.

It is important to note in the figures given above that upwind dimension of the pond has been considered a standard for comparison. The controlled-chamber investigation and the film-movement studies have established that essentially 0.5 pound of fatty alcohol film chemical must be applied per mph of wind velocity per 100 feet of shoreline normal to the prevailing wind, and within practical limitations this quantity is independent of downwind direction. The longer the pond in a downwind direction for a given upwind shoreline, the greater will be the residence time of the film on the water, and therefore the greater will be the volume of water saved per weight of evaporation retardant added. The above figure (0.5 pound of film chemical per 100 feet of shoreline normal to the prevailing wind per mph of wind velocity) was based on the experimentally determined value of 0.05 pound of film chemical needed to cover 1 acre of water in the absence of wind. If the theoretically calculated quantity of 0.02 pound is used, the requirement per 100 feet of shoreline per mph wind velocity becomes 0.2 pound instead of 1 pound.

The cost range presented in a recent American Water Works Association report (Michel, 1962) is 10 to 20 cents per 1,000 gallons of water saved; however, nothing was said as to the size of the body of water to which such costs are applicable. Controlled-chamber costs obtained in this report are in keeping with this price range.

In many of the foregoing sections of this publication, mention has been made of the possible effect of pond dimensions as related to evaporation control by the film-chemical technique. These comments, based on studies in a controlled-environment chamber, and on field studies on the rate of film movement as a function of surface-wind velocity, are related directly to the economics of a water-evaporation-control program, that is, the cost of film chemical per 1,000 gallons of water saved. For a given water-surface area, the longer the shoreline normal to the prevailing wind the greater will be the film-chemical cost for 1,000 gallons of water saved. In fact, the cost would be doubled if the length of shoreline normal to the prevailing wind were doubled. The cost is increased because twice as much film chemical must be added near the upwind shoreline in order to maintain a continuous film on the same water-surface area.

The economy of a water-evaporation-control program is tied also to climatic conditions and pond depth. The water of a shallow pond is susceptible to greater heating and cooling by existing climatic conditions than is a deep pond. The relative water-saving costs for the shallow and deep ponds reverse themselves

during periods of hot and cold weather, all other factors being equal. During periods of hot weather, when the shallow pond water is warm in comparison to the deep pond water, the cost for saving 1,000 gallons of water in the shallow pond is less than that for deep ponds. Conversely, during the winter months when the shallow pond water is cold in comparison to the deep pond water, the cost for saving 1,000 gallons in the shallow pond is greater than for the deep pond. These observations are supported by the evaporation-control studies in a controlled-environment chamber (Tables 10 and 11).

In conclusion, the investigators feel that a cost of \$1.00 per 1,000 gallons of water saved is a realistic figure for the fractional-acre farm pond up to 1/2 acre. As pond size increases to 2 or 3 acres, the cost will vary from 50 cents to a minimum of 20 cents per 1,000 gallons of water saved. However, the attainment of costs as low as 1 or 2 cents per 1,000 gallons of water saved, which have been reported for larger bodies of water, is not a reality for the small pond.

FURTHER RESEARCH NEEDS

1. Data obtained at the "twin ponds" during this investigation may be biased by "nonidentical twin" features of the test facility. The degree of "nonidentical twin" character increased each year due to erosion of the dikes. The construction of "identical twin ponds" test facilities would be desirable to remove any doubt as to the validity of the data obtained in this study. Such "identical twin ponds" could be realized if they were built on flat terrain and if their shorelines were defined by concrete sides rather than earthen dikes. Polyethylene lining of the bottoms and sides, below the concrete curbing, would be desirable. Wind-travel readings should be taken both at or near the water level and at the standard 2- or 4-foot height of weather stations. Additional instrumentations should include air and water temperature (maximum and minimum), and a humidity recorder. Evaporations could be measured either by stilling well chains or by reading the volume of water released from a water-storage tank through a constant-level system on the ponds. The latter method would be applicable to constant-pond-level evaporation studies whereas the chain technique would apply to studies where a constant level was not maintained. These "identical pond facilities" would test an application method over a 1-year period or would compare two application procedures for a 1-year period.

2. The concept of wind travel should be applied to the continuous, wind-regulated addition of liquid emulsion to a large body of water--50 to 100 acres or larger. This study could be realized first by addition from numerous inexpensive emulsion drippers spaced along the shoreline and feeding from one regulating tube, or at the most from two jets per dripper. A complex pipe distribution system then could be considered. The system would be supplied by pumps regulated through an electronic system by wind velocity. Wind velocity would thus regulate flow of emulsion to the water from the distribution system.

3. It is possible that evaporation rates could be used to establish the evaporation from large lakes. This would require humidity, temperature, and wind-travel measurements on the wind as it approaches a lake. Then by making the same readings over the water, at various distances from the shoreline, it may be possible to ascertain the amount of water picked up by a known "volume" of air. New electronic instruments are available that afford very exacting

measurements of relative humidity, and in practice, the relative humidity of the air at a given level or plane above the water may provide the evaporation data needed. This is an expensive approach. However, it may have merit in investigations of evaporation rates and evaporation-control efficiency on large bodies of water.

4. To determine watering habits from a film-covered pond, and to determine the toxicity potential of the evaporation retardant, a number of cattle (10 to 20 head) should be restricted to a pasture where water supply is provided by a metal watering tank in which the water level is maintained by a float from a supply tank. The water surface in the metal trough then should be treated with the liquid emulsion or the solid emulsion so as to maintain a film on the water. Water consumption should be determined. Also, the cattle should be watched for manifestation of ill effect of the evaporation retardant. Animals subjected to this watering procedure should be brought to slaughter at the proper time. Carcass flesh and body organs should be viewed for possible adverse effect of the emulsion or other evaporation retardant.



REFERENCES

- Atlas Powder Co., 1961a, The Atlas HLB System, how to use it in choosing emulsifiers from the thousands available: Chemmunique' [Atlas Powder Co., Wilmington, Del.], v. 9, no. 2, p. 8-13.
- _____ 1961b, A time-saving guide to emulsifier selection: Chemmunique', v. 9, no. 3, p. 13-15.
- Chemical & Engineering News, 1960, Monomolecular films aid water conservation: Chemical & Engineering News, v. 38, no. 39, p. 23-25.
- Committee of Collaborators [Grant Bloodgood, Chairman], 1959, Water-loss investigations: Lake Hefner 1958 evaporation reduction investigations: U. S. Bureau of Reclamation duplicated rept., 131 p.
- Crowe, F. R., and Daniels, E. R., 1956, Chemical means for controlling evaporation from open water surfaces: Ann. Mtg. Am. Soc. Agr. Engineers (June).
- Cruse, R. R., and Harbeck, G. E., Jr., 1960, Evaporation control research, 1955-58: U. S. Geol. Survey Water-Supply Paper 1480, 45 p.
- Drew, H. R., 1958, Suggested design of an apparatus for dispensing monomolecular film forming agents in liquid or emulsion form to water surfaces for evaporation control, in A report of the Southwest Water Evaporation Research Council: duplicated rept., p. 26.
- Eaton, E. D., 1958, Control of evaporation losses, interim report: Committee Print no. 1, 85th Congress, 2nd Session, Senate Committee on Interior and Insular Affairs; Washington, U. S. Govt. Printing Office, 44 p.
- Keulegan, G. H., 1951, Wind tides in small closed channels: Jour. Research Natl. Bur. Standards, v. 46, no. 5, p. 358-381.
- Lowry, R. L., Jr., 1960, Monthly reservoir evaporation rates for Texas, 1940 through 1957: Texas Board Water Engineers Bull. 6006, 95 p.
- Mansfield, W. W., 1953, The effect of surface films on the evaporation of water: Nature, v. 172, p. 1,101 (Dec.).
- _____ 1955, Influence of monolayers on the natural rate of evaporation of water: Nature, v. 175, p. 247-249 (Feb.).
- McArthur, I. K. H., 1962, Cetyl alcohol monolayers for water conservation, methods of application and the influence of wind: Research Applied in Industry, v. 15, p. 230-238.
- Michel, Curtis, 1962, Reduction of evaporation from reservoirs: A survey: duplicated rept., prepared for presentation at 1962 ann. conf., Am. Water Works Assoc., June 17-22, Philadelphia, Pa., 21 p.
- Vines, R. G., 1960: Paper to the Am. Chem. Soc. Symposium, New York. (Sept.)
- Weiser, H. B., 1939, Colloid chemistry: New York, John Wiley and Sons, Inc., 428 p.

